

J-Link / J-Trace *User Guide*



Software Version V6.00
Manual Rev. 1

Date: June 20, 2016

Document: UM08001

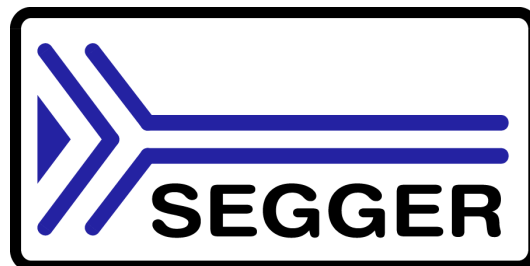

A product of SEGGER Microcontroller GmbH & Co. KG

www.segger.com

Disclaimer

Specifications written in this document are believed to be accurate, but are not guaranteed to be entirely free of error. The information in this manual is subject to change for functional or performance improvements without notice. Please make sure your manual is the latest edition. While the information herein is assumed to be accurate, SEGGER Microcontroller GmbH & Co. KG (the manufacturer) assumes no responsibility for any errors or omissions. The manufacturer makes and you receive no warranties or conditions, express, implied, statutory or in any communication with you. The manufacturer specifically disclaims any implied warranty of merchantability or fitness for a particular purpose.

Copyright notice

You may not extract portions of this manual or modify the PDF file in any way without the prior written permission of the manufacturer. The software described in this document is furnished under a license and may only be used or copied in accordance with the terms of such a license.

© 2016 SEGGER Microcontroller GmbH & Co. KG, Hilden / Germany

Trademarks

Names mentioned in this manual may be trademarks of their respective companies.

Brand and product names are trademarks or registered trademarks of their respective holders.

Contact address

SEGGER Microcontroller GmbH & Co. KG

In den Weiden 11
D-40721 Hilden

Germany

Tel. +49 2103-2878-0

Fax. +49 2103-2878-28

Email: support@segger.com

Internet: <http://www.segger.com>

Revisions

This manual describes the J-Link and J-Trace device.

For further information on topics or routines not yet specified, please contact us.

Revision	Date	By	Explanation
V6.00 Rev. 1	160617	EL	Chapter "J-Flash SPI". * Added chapter "Custom Command Sequences"
V6.00 Rev. 0	160519	AG	Chapter "Adding Support for New Devices" added.
V5.12f Rev. 0	160503	AB	Chapter "Related Software" * Section "J-Link RTT Viewer" updated and moved from section "RTT".
V5.12d Rev. 1	160427	AG	Chapter "Working with J-Link and J-Trace" * Section "J-Link script files" updated.
V5.12d Rev. 0	160425	AG	Chapter "Working with J-Link and J-Trace" * Section "J-Link script files" updated.
V5.12c Rev. 1	160418	NG	Chapter "Related Software" * Section "J-Link Commander" Typo fixed.

Revision	Date	By	Explanation
V5.12c Rev. 0	160413	NG	Chapter "Related Software" * Section "J-Link Commander" Commands and commandline options added. Chapter "Working with J-Link and J-Trace" * Section "Command strings" Command "SetRTTtelnetPort" added. Chapter "Flash Download" * Section "Debugging applications that change flash contents at runtime" added.
V5.10u Rev. 0	160317	AG	Chapter "Monitor Mode Debugging" * Section "Target application performs reset" added.
V5.10t Rev. 0	160314	AG	Chapter "Monitor Mode Debugging" * Section "Enable Monitor Debugging" updated. * Section "Forwarding of Monitor Interrupts" added.
V5.10 Rev. 3	160309	EL	Chapter "J-Flash SPI" updated.
V5.10 Rev. 2	160215	AG	Chapter "RTT" updated.
V5.10 Rev. 1	151204	AG	Chapter "RDI" updated. Chapter "Semihosting" added.
V5.10 Rev. 0	151127	NG	Chapter "Related Software" * Section "J-Scope" removed.
V5.02m Rev. 0	151125	AG	Chapter "Working with J-Link and J-Trace" * Section "The J-Link settings file" added. Chapter "Low Power Debugging" added.
V5.02l Rev. 0	151123	AG	Various Chapters * Some typos corrected.
V5.02i Rev. 1	151106	RH	Chapter "J-Flash SPI" * Section "Send custom commands" added.
V5.02i Rev. 0	151105	RH	Chapter "Related Software" * Section "J-Link Commander" exec command added. Chapter "Working with J-Link and J-Trace" * Section "Command strings" New commands added.
V5.02f Rev. 1	151022	NG	Chapter "Related Software" * Section "J-Scope" updated.
V5.02f Rev. 1	151022	EL	Chapter "Target interfaces and adapters" * Section "Reference voltage (VTref)" added.
V5.02f Rev. 0	151007	RH	Chapter "Working with J-Link and J-Trace" * Section "J-Link script files" updated.
V5.02e Rev. 0	151001	AG	Chapter "Working with J-Link and J-Trace" * Section "J-Link script files" updated.
V5.02c Rev. 1	150925	NG	Chapter "Licensing" * Section "Original SEGGER products" updated. Chapter "Flash download" * Section "Setup for various debuggers (CFI flash)" updated.
V5.02c Rev. 0	150916	RH	Chapter "Flash download" * Section "Setup for various debuggers (SPIFI flash)" added.
V5.02c Rev. 0	150914	RH	Chapter "Introduction" * Section "J-Link / J-Trace models" updated. * Section "Supported OS" Added Windows 10
V5.02a Rev. 0	150903	AG	Chapter "Monitor Mode Debugging" added.

Revision	Date	By	Explanation
V5.02 Rev. 0	150820	AG	Chapter "Working with J-Link and J-Trace" * Section "Command strings" "DisableCortexMXPSRAutoCorrectTBit" added.
V5.02 Rev. 0	150813	AG	Chapter "Monitor Mode Debugging" added.
V5.00 Rev. 1	150728	NG	Chapter "Related Software" * Section "J-Link Commander" Sub-Section "Command line options" updated.
V5.00 Rev. 0	150609	AG	Chapter "Flash download" * Section "QSPI flash support" added. Chapter "Flash breakpoints" * Section "Flash Breakpoints in QSPI flash" added
V5.00 Rev. 0	150520	EL	Chapter "J-Flash SPI" * Initial version added
V4.99b Rev. 0	150520	EL	Chapter "Related Software" * Section "J-Link STM32 Unlock" - Added command line options
V4.99a Rev. 0	150429	AG	Chapter "Target interfaces and Adapters" Chapter "20-pin J-Link connector", section "Pinout for SPI" added.
V4.98d Rev. 0	150427	EL	Chapter "Related Software" * Section "Configure SWO output after device reset" updated.
V4.98b Rev. 0	150410	AG	Chapter "Licensing" * Section "J-Trace for Cortex-M" updated.
V4.98 Rev. 0	150320	NG	Chapter "Related Software" * Section "J-Link Commander" Sub-Section "Commands" added. Chapter "Working with J-Link and J-Trace" * Section "J-Link script files" updated
V4.96f Rev. 0	150204	JL	Chapter "Related Software" * Section "GDB Server" Exit code description added.
V4.96 Rev. 0	141219	JL	Chapter "RTT" added. Chapter "Related Software" * Section "GDB Server" Command line option "-strict" added. Command line option "-timeout" added.
V4.90d Rev. 0	141112	NG	Chapter "Related Software" * Section "J-Link Remote Server" updated. * Section "J-Scope" updated.
V4.90c Rev. 0	140924	JL	Chapter "Related Software" * Section "JTAGLoad" updated.
V4.90b Rev. 1	140813	EL	Chapter "Working with J-Link and J-Trace" * Section "Connecting multiple J-Links / J-Traces to your PC" updated Chapter "J-Link software" * Section "J-Link Configurator" updated.
V4.90b Rev. 0	140813	NG	Chapter "Related Software" * Section "J-Scope" added.
V4.86 Rev. 2	140606	AG	Chapter "Device specifics" * Section "Silicon Labs - EFM32 series devices" added
V4.86 Rev. 1	140527	JL	Chapter "Related Software" * Section "GDB Server" Command line options -halt / -nohalt added. Description for GDB Server CL version added.

Revision	Date	By	Explanation
V4.86 Rev. 0	140519	AG	Chapter "Flash download" Section "Mentor Sourcery CodeBench" added.
V4.84 Rev. 0	140321	EL	Chapter "Working with J-Link" * Section "Virtual COM Port (VCOM) improved. Chapter "Target interfaces and adapters" * Section "Pinout for SWD + Virtual COM Port (VCOM) added."
V4.82 Rev. 1	140228	EL	Chapter "Related Software" * Section "Command line options" Extended command line option -speed. Chapter "J-Link software and documentation package" * Section "J-Link STR91x Commander" Added command line option parameter to specify a customized scan-chain. Chapter "Working with J-Link" * Section "Virtual COM Port (VCOM) added. Chapter "Setup" * Section "Getting started with J-Link and DS-5"
V4.82 Rev. 0	140218	JL	Chapter "Related Software" * Section "GDB Server" Command line option -notimout added.
V4.80f Rev. 0	140204	JL	Chapter "Related Software" * Section "GDB Server" Command line options and remote commands added.
V4.80 Rev. 1	131219	JL/ NG	Chapter "Related Software" * Section "GDB Server" Remote commands and command line options description improved. Several corrections.
V4.80 Rev. 0	131105	JL	Chapter "Related Software" * Section "GDB Server" SEGGER-specific GDB protocol extensions added.
V4.76 Rev. 3	130823	JL	Chapter "Flash Download" * Replaced references to GDB Server manual. Chapter "Working withc J-Link" * Replaced references to GDB Server manual.
V4.76 Rev. 2	130821	JL	Chapter "Related Software" * Section "GDB Server" Remote commands added.
V4.76 Rev. 1	130819	JL	Chapter "Related Software" * Section "SWO Viewer" Sample code updated.
V4.76 Rev. 0	130809	JL	Chapter "Related Software" * Sections reordered and updated. Chapter "Setup" * Section "Using JLinkARM.dll moved here.
V4.71b Rev. 0	130507	JL	Chapter "Related Software" * Section "SWO Viewer" Added new command line options.
V4.66 Rev. 0	130221	JL	Chapter "Introduction" * Section "Supported OS" Added Linux and Mac OSX

Revision	Date	By	Explanation
V4.62b Rev. 0	130219	EL	Chapter "Introduction" * Section "J-Link / J-Trace models" Clock rise and fall times updated.
V4.62 Rev. 0	130129	JL	Chapter "Introduction" * Section "J-Link / J-Trace models" Sub-section "J-link ULTRA" updated.
V4.62 Rev. 0	130124	EL	Chapter "Target interfaces and adapters" * Section "9-pin JTAG/SWD connector" Pinout description corrected.
V4.58 Rev. 1	121206	AG	Chapter "Intoduction" * Section "J-Link / J-Trace models" updated.
V4.58 Rev. 0	121126	JL	Chapter "Working with J-Link" * Section "J-Link script files" Sub-section "Executing J-Link script files" updated.
V4.56b Rev. 0	121112	JL	Chapter "Related Software" * Section "J-Link SWO Viewer" Added sub-section "Configure SWO output after device reset"
V4.56a Rev. 0	121106	JL	Chapter "Related Software" * Section "J-Link Commander" Renamed "Commander script files" to "Commander files" and "script mode" to "batch mode".
V4.56 Rev. 0	121022	AG	Renamed "J-Link TCP/IP Server" to "J-Link Remote Server".
V4.54 Rev. 1	121009	JL	Chapter "Related Software" * Section "TCP/IP Server", subsection "Tunneling Mode" added.
V4.54 Rev. 0	120913	EL	Chapter "Flash Breakpoints" * Section "Licensing" updated. Chapter "Device specifics" * Section "Freescale", subsection "Data flash support" added.
V4.53c Rev. 0	120904	EL	Chapter "Licensing" * Section "Device-based license" updated.
V4.51h Rev. 0	120717	EL	Chapter "Flash download" * Section "J-Link commander" updated. Chapter "Support and FAQs" * Section "Frequently asked questions" updated. Chapter "J-Link and J-Trace related software" * Section "J-Link Commander" updated.
V4.51e Rev. 1	120704	EL	Chapter "Working with J-Link" * Section "Reset strategies" updated and corrected. Added reset type 8.
V4.51e Rev. 0	120704	AG	Chapter "Device specifics" * Section "ST" updated and corrected.
V4.51b Rev. 0	120611	EL	Chapter "J-Link and J-Trace related software" * Section "SWO Viewer" added.
V4.51a Rev. 0	120606	EL	Chapter "Device specifics" * Section "ST", subsection "ETM init" for some STM32 devices added.. * Section "Texas Instruments" updated. Chapter "Target interfaces and adapters" * Section "Pinout for SWD" updated.
V4.47a Rev. 0	120419	AG	Chapter "Device specifics" * Section "Texas Instruments" updated.

Revision	Date	By	Explanation
V4.46 Rev. 0	120416	EL	Chapter "Support" updated.
V4.42 Rev. 0	120214	EL	Chapter "Working with J-Link" * Section "J-Link script files" updated.
V4.36 Rev. 1	110927	EL	Chapter "Flash download" added. Chapter "Flash breakpoints" added. Chapter "Target interfaces and adapters" * Section "20-pin JTAG/SWD connector" updated. Chapter "RDI" added. Chapter "Setup" updated. Chapter "Device specifics" updated.
V4.36 Rev. 0	110909	AG	Chapter "Working with J-Link" * Section "J-Link script files" updated.
V4.26 Rev. 1	110513	KN	Chapter "Introduction" * Section "J-Link / J-Trace models" corrected.
V4.26 Rev. 0	110427	KN	Several corrections.
V4.24 Rev. 1	110228	AG	Chapter "Introduction" * Section "J-Link / J-Trace models" corrected. Chapter "Device specifics" * Section "ST Microelectronics" updated.
V4.24 Rev. 0	110216	AG	Chapter "Device specifics" * Section "Samsung" added. Chapter "Working with J-Link" * Section "Reset strategies" updated. Chapter "Target interfaces and adapters" * Section "9-pin JTAG/SWD connector" added.
V4.23d	110202	AG	Chapter "J-Link and J-Trace related software" * Section "J-Link software and documentation package in detail" updated. Chapter "Introduction" * Section "Built-in intelligence for supported CPU-cores" added.
V4.21g	101130	AG	Chapter "Working with J-Link" * Section "Reset strategies" updated. Chapter "Device specifics" * Section "Freescale" updated. Chapter "Flash download and flash breakpoints" * Section "Supported devices" updated * Section "Setup for different debuggers (CFI flash)" updated.
V4.21	101025	AG	Chapter "Device specifics" * Section "Freescale" updated.
V4.20j	101019	AG	Chapter "Working with J-Link" * Section "Reset strategies" updated.
V4.20b	100923	AG	Chapter "Working with J-Link" * Section "Reset strategies" updated.
90	100818	AG	Chapter "Working with J-Link" * Section "J-Link script files" updated. * Section "Command strings" updated. Chapter "Target interfaces and adapters" * Section "19-pin JTAG/SWD and Trace connector" corrected. Chapter "Setup" * Section "J-Link configurator added."
89	100630	AG	Several corrections.
88	100622	AG	Chapter "J-Link and J-Trace related software" * Section "SWO Analyzer" added.
87	100617	AG	Several corrections.

Revision	Date	By	Explanation
86	100504	AG	Chapter "Introduction" * Section "J-Link / J-Trace models" updated. Chapter "Target interfaces and adapters" * Section "Adapters" updated.
85	100428	AG	Chapter "Introduction" * Section "J-Link / J-Trace models" updated.
84	100324	KN	Chapter "Working with J-Link and J-Trace" * Several corrections Chapter Flash download & flash breakpoints * Section "Supported devices" updated
83	100223	KN	Chapter "Introduction" * Section "J-Link / J-Trace models" updated.
82	100215	AG	Chapter "Working with J-Link" * Section "J-Link script files" added.
81	100202	KN	Chapter "Device Specifics" * Section "Luminary Micro" updated. Chapter "Flash download and flash breakpoints" * Section "Supported devices" updated.
80	100104	KN	Chapter "Flash download and flash breakpoints" * Section "Supported devices" updated
79	091201	AG	Chapter "Working with J-Link and J-Trace" * Section "Reset strategies" updated. Chapter "Licensing" * Section "J-Link OEM versions" updated.
78	091023	AG	Chapter "Licensing" * Section "J-Link OEM versions" updated.
77	090910	AG	Chapter "Introduction" * Section "J-Link / J-Trace models" updated.
76	090828	KN	Chapter "Introduction" * Section "Specifications" updated * Section "Hardware versions" updated * Section "Common features of the J-Link product family" updated Chapter "Target interfaces and adapters" * Section "5 Volt adapter" updated
75	090729	AG	Chapter "Introduction" * Section "J-Link / J-Trace models" updated. Chapter "Working with J-Link and J-Trace" * Section "SWD interface" updated.
74	090722	KN	Chapter "Introduction" * Section "Supported IDEs" added * Section "Supported CPU cores" updated * Section "Model comparison chart" renamed to "Model comparison" * Section "J-Link bundle comparison chart" removed
73	090701	KN	Chapter "Introduction" * Section "J-Link and J-Trace models" added * Sections "Model comparison chart" & "J-Link bundle comparison chart" added Chapter "J-Link and J-Trace models" removed Chapter "Hardware" renamed to "Target interfaces & adapters" * Section "JTAG Isolator" added Chapter "Target interfaces and adapters" * Section "Target board design" updated Several corrections

Revision	Date	By	Explanation
72	090618	AG	Chapter "Working with J-Link" * Section "J-Link control panel" updated. Chapter "Flash download and flash breakpoints" * Section "Supported devices" updated. Chapter "Device specifics" * Section "NXP" updated.
71	090616	AG	Chapter "Device specifics" * Section "NXP" updated.
70	090605	AG	Chapter "Introduction" * Section "Common features of the J-Link product family" updated.
69	090515	AG	Chapter "Working with J-Link" * Section "Reset strategies" updated. * Section "Indicators" updated. Chapter "Flash download and flash breakpoints" * Section "Supported devices" updated.
68	090428	AG	Chapter "J-Link and J-Trace related software" * Section "J-Link STM32 Commander" added. Chapter "Working with J-Link" * Section "Reset strategies" updated.
67	090402	AG	Chapter "Working with J-Link" * Section "Reset strategies" updated.
66	090327	AG	Chapter "Background information" * Section "Embedded Trace Macrocell (ETM)" updated. Chapter "J-Link and J-Trace related software" * Section "Dedicated flash programming utilities for J-Link" updated.
65	090320	AG	Several changes in the manual structure.
64	090313	AG	Chapter "Working with J-Link" * Section "Indicators" added.
63	090212	AG	Chapter "Hardware" * Several corrections. * Section "Hardware Versions" Version 8.0 added.
62	090211	AG	Chapter "Working with J-Link and J-Trace" * Section "Reset strategies" updated. Chapter J-Link and J-Trace related software * Section "J-Link STR91x Commander (Command line tool)" updated. Chapter "Device specifics" * Section "ST Microelectronics" updated. Chapter "Hardware" updated.
61	090120	TQ	Chapter "Working with J-Link" * Section "Cortex-M3 specific reset strategies"
60	090114	AG	Chapter "Working with J-Link" * Section "Cortex-M3 specific reset strategies"
59	090108	KN	Chapter Hardware * Section "Target board design for JTAG" updated. * Section "Target board design for SWD" added.
58	090105	AG	Chapter "Working with J-Link Pro" * Section "Connecting J-Link Pro the first time" updated.

Revision	Date	By	Explanation
57	081222	AG	Chapter "Working with J-Link Pro" * Section "Introduction" updated. * Section "Configuring J-Link Pro via web interface" updated. Chapter "Introduction" * Section "J-Link Pro overview" updated.
56	081219	AG	Chapter "Working with J-Link Pro" * Section "FAQs" added. Chapter "Support and FAQs" * Section "Frequently Asked Questions" updated.
55	081218	AG	Chapter "Hardware" updated.
54	081217	AG	Chapter "Working with J-Link and J-Trace" * Section "Command strings" updated.
53	081216	AG	Chapter "Working with J-Link Pro" updated.
52	081212	AG	Chapter "Working with J-Link Pro" added. Chapter "Licensing" * Section "Original SEGGER products" updated.
51	081202	KN	Several corrections.
50	081030	AG	Chapter "Flash download and flash breakpoints" * Section "Supported devices" corrected.
49	081029	AG	Several corrections.
48	080916	AG	Chapter "Working with J-Link and J-Trace" * Section "Connecting multiple J-Links / J-Traces to your PC" updated.
47	080910	AG	Chapter "Licensing" updated.
46	080904	AG	Chapter "Licensing" added. Chapter "Hardware" Section "J-Link OEM versions" moved to chapter "Licensing"
45	080902	AG	Chapter "Hardware" Section "JTAG+Trace connector" JTAG+Trace connector pinout corrected. Section "J-Link OEM versions" updated.
44	080827	AG	Chapter "J-Link control panel" moved to chapter "Working with J-Link". Several corrections.
43	080826	AG	Chapter "Flash download and flash breakpoints" Section "Supported devices" updated.
42	080820	AG	Chapter "Flash download and flash breakpoints" Section "Supported devices" updated.
41	080811	AG	Chapter "Flash download and flash breakpoints" updated. Chapter "Flash download and flash breakpoints", section "Supported devices" updated.
40	080630	AG	Chapter "Flash download and flash breakpoints" updated. Chapter "J-Link status window" renamed to "J-Link control panel" Various corrections.
39	080627	AG	Chapter "Flash download and flash breakpoints" Section "Licensing" updated. Section "Using flash download and flash breakpoints with different debuggers" updated. Chapter "J-Link status window" added.

Revision	Date	By	Explanation
38	080618	AG	Chapter "Support and FAQs" Section "Frequently Asked Questions" updated Chapter "Reset strategies" Section "Cortex-M3 specific reset strategies" updated.
37	080617	AG	Chapter "Reset strategies" Section "Cortex-M3 specific reset strategies" updated.
36	080530	AG	Chapter "Hardware" Section "Differences between different versions" updated. Chapter "Working with J-Link and J-Trace" Section "Cortex-M3 specific reset strategies" added.
35	080215	AG	Chapter "J-Link and J-Trace related software" Section "J-Link software and documentation package in detail" updated.
34	080212	AG	Chapter "J-Link and J-Trace related software" Section "J-Link TCP/IP Server (Remote J-Link / J-Trace use)" updated. Chapter "Working with J-Link and J-Trace" Section "Command strings" updated. Chapter "Flash download and flash breakpoints" Section "Introduction" updated. Section "Licensing" updated. Section "Using flash download and flash breakpoints with different debuggers" updated.
33	080207	AG	Chapter "Flash download and flash breakpoints" added Chapter "Device specifics": Section "ATMEL - AT91SAM7 - Recommended init sequence" added.
32	0080129	SK	Chapter "Device specifics": Section "NXP - LPC - Fast GPIO bug" list of device enhanced.
31	0080103	SK	Chapter "Device specifics": Section "NXP - LPC - Fast GPIO bug" updated.
30	071211	AG	Chapter "Device specifics": Section "Analog Devices" updated. Section "ATMEL" updated. Section "Freescale" added. Section "Luminary Micro" added. Section "NXP" updated. Section "OKI" added. Section "ST Microelectronics" updated. Section "Texas Instruments" updated. Chapter "Related software": Section "J-Link STR91x Commander" updated
29	070912	SK	Chapter "Hardware", section "Target board design" updated.
28	070912	SK	Chapter "Related software": Section "J-LinkSTR91x Commander" added. Chapter "Device specifics": Section "ST Microelectronics" added. Section "Texas Instruments" added. Subsection "AT91SAM9" added.

Revision	Date	By	Explanation
28	070912	AG	Chapter "Working with J-Link/J-Trace": Section "Command strings" updated.
27	070827	TQ	Chapter "Working with J-Link/J-Trace": Section "Command strings" updated.
26	070710	SK	Chapter "Introduction": Section "Features of J-Link" updated. Chapter "Background Information": Section "Embedded Trace Macrocell" added. Section "Embedded Trace Buffer" added.
25	070516	SK	Chapter "Working with J-Link/J-Trace": Section "Reset strategies in detail" - "Software, for Analog Devices ADuC7xxx MCUs" updated - "Software, for ATMEL AT91SAM7 MCUs" added. Chapter "Device specifics" Section "Analog Devices" added. Section "ATMEL" added.
24	070323	SK	Chapter "Setup": "Uninstalling the J-Link driver" updated. "Supported ARM cores" updated.
23	070320	SK	Chapter "Hardware": "Using the JTAG connector with SWD" updated.
22	070316	SK	Chapter "Hardware": "Using the JTAG connector with SWD" added.
21	070312	SK	Chapter "Hardware": "Differences between different versions" supplemented.
20	070307	SK	Chapter "J-Link / J-Trace related software": "J-Link GDB Server" licensing updated.
19	070226	SK	Chapter "J-Link / J-Trace related software" updated and reorganized. Chapter "Hardware" "List of OEM products" updated
18	070221	SK	Chapter "Device specifics" added Subchapter "Command strings" added
17	070131	SK	Chapter "Hardware": "Version 5.3": Current limits added "Version 5.4" added Chapter "Setup": "Installing the J-Link USB driver" removed. "Installing the J-Link software and documentation pack" added. Subchapter "List of OEM products" updated. "OS support" updated
16	061222	SK	Chapter "Preface": "Company description" added. J-Link picture changed.
15	060914	OO	Subchapter 1.5.1: Added target supply voltage and target supply current to specifications. Subchapter 5.2.1: Pictures of ways to connect J-Trace.
14	060818	TQ	Subchapter 4.7 "Using DCC for memory reads" added.
13	060711	OO	Subchapter 5.2.2: Corrected JTAG+Trace connector pinout table.
12	060628	OO	Subchapter 4.1: Added ARM966E-S to List of supported ARM cores.

Revision	Date	By	Explanation
11	060607	SK	Subchapter 5.5.2.2 changed. Subchapter 5.5.2.3 added.
10	060526	SK	ARM9 download speed updated. Subchapter 8.2.1: Screenshot "Start sequence" updated. Subchapter 8.2.2 "ID sequence" removed. Chapter "Support" and "FAQ" merged. Various improvements
9	060324	OO	Chapter "Literature and references" added. Chapter "Hardware": Added common information trace signals. Added timing diagram for trace. Chapter "Designing the target board for trace" added.
8	060117	OO	Chapter "Related Software": Added JLinkARM.dll. Screenshots updated.
7	051208	OO	Chapter Working with J-Link: Sketch added.
6	051118	OO	Chapter Working with J-Link: "Connecting multiple J-Links to your PC" added. Chapter Working with J-Link: "Multi core debugging" added. Chapter Background information: "J-Link firmware" added.
5	051103	TQ	Chapter Setup: "JTAG Speed" added.
4	051025	OO	Chapter Background information: "Flash programming" added. Chapter Setup: "Scan chain configuration" added. Some smaller changes.
3	051021	TQ	Performance values updated.
2	051011	TQ	Chapter "Working with J-Link" added.
1	050818	TW	Initial version.

About this document

Assumptions

This document assumes that you already have a solid knowledge of the following:

- The software tools used for building your application (assembler, linker, C compiler)
- The C programming language
- The target processor
- DOS command line

If you feel that your knowledge of C is not sufficient, we recommend *The C Programming Language* by Kernighan and Ritchie (ISBN 0-13-1103628), which describes the standard in C-programming and, in newer editions, also covers the ANSI C standard.

How to use this manual

This manual explains all the functions and macros that the product offers. It assumes you have a working knowledge of the C language. Knowledge of assembly programming is not required.

Typographic conventions for syntax

This manual uses the following typographic conventions:

Style	Used for
Body	Body text.
Keyword	Text that you enter at the command-prompt or that appears on the display (that is system functions, file- or pathnames).
Parameter	Parameters in API functions.
Sample	Sample code in program examples.
Sample comment	Comments in programm examples.
Reference	Reference to chapters, sections, tables and figures or other documents.
GUIElement	Buttons, dialog boxes, menu names, menu commands.
Emphasis	Very important sections.

Table 1.1: Typographic conventions



SEGGER Microcontroller GmbH & Co. KG develops and distributes software development tools and ANSI C software components (middleware) for embedded systems in several industries such as telecom, medical technology, consumer electronics, automotive industry and industrial automation.

SEGGER's intention is to cut software development time for embedded applications by offering compact flexible and easy to use middleware, allowing developers to concentrate on their application.

Our most popular products are emWin, a universal graphic software package for embedded applications, and embOS, a small yet efficient real-time kernel. emWin, written entirely in ANSI C, can easily be used on any CPU and most any display. It is complemented by the available PC tools: Bitmap Converter, Font Converter, Simulator and Viewer. embOS supports most 8/16/32-bit CPUs. Its small memory footprint makes it suitable for single-chip applications.

Apart from its main focus on software tools, SEGGER develops and produces programming tools for flash micro controllers, as well as J-Link, a JTAG emulator to assist in development, debugging and production, which has rapidly become the industry standard for debug access to ARM cores.

Corporate Office:

<http://www.segger.com>

United States Office:

<http://www.segger-us.com>

EMBEDDED SOFTWARE (Middleware)



emWin

Graphics software and GUI

emWin is designed to provide an efficient, processor- and display controller-independent graphical user interface (GUI) for any application that operates with a graphical display.



embOS

Real Time Operating System

embOS is an RTOS designed to offer the benefits of a complete multitasking system for hard real time applications with minimal resources.



embOS/IP

TCP/IP stack

embOS/IP a high-performance TCP/IP stack that has been optimized for speed, versatility and a small memory footprint.



emFile

File system

emFile is an embedded file system with FAT12, FAT16 and FAT32 support. Various Device drivers, e.g. for NAND and NOR flashes, SD/MMC and Compact-Flash cards, are available.



USB-Stack

USB device/host stack

A USB stack designed to work on any embedded system with a USB controller. Bulk communication and most standard device classes are supported.

SEGGER TOOLS

Flasher

Flash programmer

Flash Programming tool primarily for micro controllers.

J-Link

JTAG emulator for ARM cores

USB driven JTAG interface for ARM cores.

J-Trace

JTAG emulator with trace

USB driven JTAG interface for ARM cores with Trace memory. supporting the ARM ETM (Embedded Trace Macrocell).

J-Link / J-Trace Related Software

Add-on software to be used with SEGGER's industry standard JTAG emulator, this includes flash programming software and flash breakpoints.

Table 1.1:



Table of Contents

1	Introduction	25
1.1	Requirements.....	26
1.2	Supported OS	27
1.3	J-Link / J-Trace models	28
1.3.1	Model comparison.....	29
1.3.2	J-Link BASE	30
1.3.3	J-Link PLUS	36
1.3.4	J-Link ULTRA+	41
1.3.5	J-Link PRO.....	46
1.3.6	J-Link Lite ARM	50
1.3.7	J-Link Lite CortexM	51
1.3.8	J-Trace ARM	52
1.3.9	J-Trace for Cortex-M	54
1.3.10	Flasher ARM.....	57
1.4	Common features of the J-Link product family	59
1.5	Supported CPU cores	60
1.6	Built-in intelligence for supported CPU-cores	61
1.6.1	Intelligence in the J-Link firmware	61
1.6.2	Intelligence on the PC-side (DLL).....	61
1.6.3	Firmware intelligence per model	63
1.7	Supported IDEs	65
2	Licensing.....	67
2.1 Components requiring a license	68
2.2	License types	69
2.2.1	Built-in license	69
2.2.2	Key-based license.....	69
2.3	Legal use of SEGGER J-Link software.....	70
2.3.1	Use of the software with 3rd party tools.....	70
2.4	Original SEGGER products.....	71
2.4.1	J-Link BASE	71
2.4.2	J-Link PLUS	71
2.4.3	J-link ULTRA+	72
2.4.4	J-Link PRO.....	72
2.4.5	J-Trace ARM	72
2.4.6	J-Trace for Cortex-M	73
2.4.7	Flasher ARM.....	74
2.4.8	Flasher RX.....	74
2.4.9	Flasher PPC	75
2.5	J-Link OEM versions.....	76
2.5.1	Analog Devices: mIDASLink	76
2.5.2	Atmel: SAM-ICE	76
2.5.3	Digi: JTAG Link.....	77
2.5.4	IAR: J-Link / J-Link KS	77
2.5.5	IAR: J-Link Lite	77
2.5.6	IAR: J-Trace	78
2.5.7	NXP: J-Link Lite LPC Edition	78
2.5.8	SEGGER: J-Link Lite ARM.....	78
2.6	J-Link OBs	79
2.7	Illegal Clones	80

3	J-Link software and documentation package.....	81
3.1	Software overview.....	82
3.2	J-Link Commander (Command line tool).....	83
3.2.1	Commands.....	84
3.2.2	Command line options.....	100
3.2.3	Using command files.....	103
3.3	J-Link GDB Server.....	104
3.3.1	J-Link GDB Server CL (Windows, Linux, Mac).....	104
3.3.2	Debugging with J-Link GDB Server.....	105
3.3.3	Supported remote (monitor) commands.....	110
3.3.4	SEGGER-specific GDB protocol extensions.....	122
3.3.5	Command line options.....	125
3.3.6	Program termination.....	136
3.3.7	Semihosting.....	137
3.4	J-Link Remote Server.....	138
3.4.1	List of available commands.....	138
3.4.2	Tunneling mode.....	139
3.5	J-Mem Memory Viewer.....	142
3.6	J-Flash.....	143
3.7	J-Link RTT Viewer.....	144
3.7.1	RTT Viewer Startup.....	144
3.7.2	Connection Settings.....	145
3.7.3	The Terminal Tabs.....	145
3.7.4	Sending Input.....	146
3.7.5	Logging Terminal output.....	146
3.7.6	Logging Data.....	147
3.7.7	Command line options.....	147
3.7.8	Menus and Shortcuts.....	149
3.7.9	Using "virtual" Terminals in RTT.....	151
3.7.10	Using Text Control Codes.....	151
3.8	J-Link SWO Viewer.....	152
3.8.1	Usage.....	153
3.8.2	List of available command line options.....	153
3.8.3	Configure SWO output after device reset.....	155
3.8.4	Target example code for terminal output.....	155
3.9	SWO Analyzer.....	158
3.10	JTAGLoad (Command line tool).....	159
3.11	J-Link RDI (Remote Debug Interface).....	160
3.11.1	Flash download and flash breakpoints.....	160
3.12	Processor specific tools.....	161
3.12.1	J-Link STR91x Commander (Command line tool).....	161
3.12.2	J-Link STM32 Unlock (Command line tool).....	162
3.13	J-Link Software Developer Kit (SDK).....	165
4	Setup.....	167
4.1	Installing the J-Link software and documentation pack.....	168
4.1.1	Setup procedure.....	168
4.2	Setting up the USB interface.....	171
4.2.1	Verifying correct driver installation.....	171
4.2.2	Uninstalling the J-Link USB driver.....	172
4.3	Setting up the IP interface.....	174
4.3.1	Configuring J-Link using J-Link Configurator.....	174
4.3.2	Configuring J-Link using the webinterface.....	174
4.4	FAQs.....	176
4.5	J-Link Configurator.....	177
4.5.1	Configure J-Links using the J-Link Configurator.....	177
4.6	J-Link USB identification.....	179
4.6.1	Connecting to different J-Links connected to the same host PC via USB.....	179
4.7	Using the J-Link DLL.....	181
4.7.1	What is the JLink DLL?.....	181

4.7.2	Updating the DLL in third-party programs	181
4.7.3	Determining the version of JLink DLL.....	182
4.7.4	Determining which DLL is used by a program	182
4.8	Getting started with J-Link and ARM DS-5	183
4.8.1	Replacing the RDDI DLL manually	183
4.8.2	Using J-Link in DS-5 Development Studio	183
5	Working with J-Link and J-Trace.....	185
5.1	Connecting the target system.....	186
5.1.1	Power-on sequence.....	186
5.1.2	Verifying target device connection	186
5.1.3	Problems	186
5.2	Indicators	187
5.2.1	Main indicator	187
5.2.2	Input indicator	189
5.2.3	Output indicator	189
5.3	JTAG interface.....	190
5.3.1	Multiple devices in the scan chain	190
5.3.2	Sample configuration dialog boxes	190
5.3.3	Determining values for scan chain configuration.....	193
5.3.4	JTAG Speed	194
5.4	SWD interface.....	195
5.4.1	SWD speed.....	195
5.4.2	SWO.....	195
5.5	Multi-core debugging	197
5.5.1	How multi-core debugging works	197
5.5.2	Using multi-core debugging in detail	198
5.5.3	Things you should be aware of	199
5.6	Connecting multiple J-Links / J-Traces to your PC	201
5.6.1	How does it work?	201
5.7	J-Link control panel.....	203
5.7.1	Tabs	203
5.8	Reset strategies	209
5.8.1	Strategies for ARM 7/9 devices.....	209
5.8.2	Strategies for Cortex-M devices	211
5.9	Using DCC for memory access	214
5.9.1	What is required?	214
5.9.2	Target DCC handler	214
5.9.3	Target DCC abort handler	214
5.10	The J-Link settings file.....	215
5.10.1	SEGGER Embedded Studio	215
5.10.2	Keil MDK-ARM (uVision).....	215
5.10.3	IAR EWARM	215
5.10.4	Mentor Sourcery CodeBench for ARM.....	215
5.11	J-Link script files	216
5.11.1	Actions that can be customized	216
5.11.2	Script file API functions	217
5.11.3	Global DLL variables	223
5.11.4	Global DLL constants.....	227
5.11.5	Script file language	228
5.11.6	Script file writing example	229
5.11.7	Executing J-Link script files	230
5.12	Command strings	233
5.12.1	List of available commands	233
5.12.2	Using command strings	251
5.13	Switching off CPU clock during debug	253
5.14	Cache handling.....	254
5.14.1	Cache coherency	254
5.14.2	Cache clean area	254
5.14.3	Cache handling of ARM7 cores.....	254
5.14.4	Cache handling of ARM9 cores.....	254

5.15	Virtual COM Port (VCOM).....	255
5.15.1	Configuring Virtual COM Port	255
6	Flash download.....	257
6.1	Introduction	258
6.2	Licensing.....	259
6.3	Supported devices.....	260
6.4	Setup for various debuggers (internal flash)	261
6.4.1	IAR Embedded Workbench	261
6.4.2	Keil MDK.....	261
6.4.3	Mentor Sourcery CodeBench	264
6.4.4	J-Link GDB Server	264
6.4.5	J-Link Commander	265
6.4.6	J-Link RDI.....	266
6.5	Setup for various debuggers (CFI flash)	267
6.5.1	IAR Embedded Workbench / Keil MDK.....	267
6.5.2	J-Link GDB Server	268
6.5.3	J-Link commander.....	268
6.6	Setup for various debuggers (SPIFI flash).....	269
6.7	QSPI flash support	270
6.7.1	Setup the DLL for QSPI flash download	270
6.8	Using the DLL flash loaders in custom applications.....	271
6.9	Debugging applications that change flash contents at runtime	272
7	Flash breakpoints.....	273
7.1	Introduction	274
7.2	Licensing.....	275
7.2.1	Free for evaluation and non-commercial use	275
7.3	Supported devices.....	276
7.4	Setup & compatibility with various debuggers	277
7.4.1	Setup	277
7.4.2	Compatibility with various debuggers.....	277
7.5	Flash Breakpoints in QSPI flash	278
7.5.1	Setup	278
7.6	FAQ.....	279
8	Monitor Mode Debugging.....	281
8.1	Introduction	282
8.2	Enable Monitor Debugging.....	283
8.2.1	GDB based debug solutions	283
8.2.2	IAR EWARM.....	283
8.2.3	Keil MDK-ARM (uVision)	284
8.2.4	J-Link Commander	284
8.2.5	Generic way of enabling	284
8.3	Availability and limitations of monitor mode	285
8.3.1	Cortex-M3	285
8.3.2	Cortex-M4	285
8.4	Monitor code	286
8.5	Debugging interrupts.....	287
8.6	Having servicing interrupts in debug mode	288
8.7	Forwarding of Monitor Interrupts	289
8.8	Target application performs reset (Cortex-M).....	290
9	Low Power Debugging.....	291
9.1	Introduction	292
9.2	Activating low power mode handling for J-Link	293
9.2.1	SEGGER Embedded Studio	293
9.2.2	Keil MDK-ARM.....	293
9.2.3	IAR EWARM.....	293

9.2.4	Mentor Sourcery CodeBench for ARM.....	293
9.2.5	GDB + GDBServer based setups (Eclipse etc.)	293
9.3	Restrictions.....	294
10	Adding Support for New Devices	295
10.1	Introduction.....	296
10.2	General procedure	297
10.3	Adding a new device	298
10.4	Editing/Extending an Existing Device	299
10.5	XML Tags and Attributes.....	300
10.5.1	<Database>	300
10.5.2	<Device>	300
10.5.3	<ChipInfo>	300
10.5.4	<FlashBankInfo>.....	302
10.6	Example XML file	304
10.7	Add. info / Considerations / Limitations	305
10.7.1	CMSIS flash algorithms	305
10.7.2	Customized Flash Banks	305
11	J-Flash SPI	307
11.1	Introduction.....	308
11.1.1	What is J-Flash SPI?.....	308
11.1.2	J-Flash SPI CL (Windows, Linux, Mac)	308
11.1.3	Features.....	308
11.1.4	Requirements.....	308
11.2	Licensing	310
11.2.1	Introduction.....	310
11.3	Getting Started	311
11.3.1	Setup.....	311
11.3.2	Using J-Flash SPI for the first time	311
11.3.3	Menu structure.....	312
11.4	Settings	316
11.4.1	Project Settings.....	316
11.4.2	Global Settings.....	319
11.5	Command Line Interface.....	321
11.5.1	Overview	321
11.5.2	Command line options.....	321
11.5.3	Batch processing	323
11.5.4	Programming multiple targets in parallel.....	323
11.6	Create a new J-Flash SPI project	325
11.6.1	Creating a new J-Flash SPI project	325
11.7	Custom Command Sequences	326
11.7.1	Init / Exit steps	326
11.7.2	Example	326
11.7.3	J-Flash SPI Command Line Version	327
11.8	Device specifics	330
11.8.1	SPI flashes with multiple erase commands	330
11.9	Target systems	331
11.9.1	Which flash devices can be programmed?	331
11.10	Performance	332
11.10.1	Performance values	332
11.11	Background information	333
11.11.1	SPI interface connection	333
11.12	Support.....	334
11.12.1	Troubleshooting	334
11.12.2	Contacting support	334
12	RDI.....	335
12.1	Introduction.....	336
12.1.1	Features.....	336

12.2	Licensing.....	337
12.3	Setup for various debuggers	338
12.3.1	IAR Embedded Workbench IDE	338
12.3.2	ARM AXD (ARM Developer Suite, ADS)	341
12.3.3	ARM RVDS (RealView developer suite)	343
12.3.4	GHS MULTI	348
12.3.5	KEIL MDK (μ Vision IDE)	351
12.4	Configuration.....	354
12.4.1	Configuration file JLinkRDI.ini	354
12.4.2	Using different configurations	354
12.4.3	Using multiple J-Links simultaneously	354
12.4.4	Configuration dialog	354
12.5	Semihosting	363
12.5.1	Unexpected / unhandled SWIs	363
13	RTT	365
13.1	Introduction	366
13.2	How RTT works	367
13.2.1	Target implementation.....	367
13.2.2	Locating the Control Block.....	367
13.2.3	Internal structures	367
13.2.4	Requirements	368
13.2.5	Performance.....	369
13.2.6	Memory footprint	369
13.3	RTT Communication	370
13.3.1	RTT Viewer.....	370
13.3.2	RTT Client	370
13.3.3	RTT Logger.....	370
13.3.4	RTT in other host applications	370
13.4	Implementation	371
13.4.1	API functions	371
13.4.2	Configuration defines	377
13.5	ARM Cortex - Background memory access	379
13.6	Example code	380
13.7	FAQ.....	381
14	Device specifics	383
14.1	Analog Devices	384
14.1.1	ADuC7xxx	384
14.2	ATMEL	386
14.2.1	AT91SAM7	387
14.2.2	AT91SAM9	389
14.3	DSPGroup	390
14.4	Ember	391
14.5	Energy Micro	392
14.6	Freescale	393
14.6.1	Kinetis family.....	393
14.7	Fujitsu	396
14.8	Itron	397
14.9	Infineon.....	398
14.10	Luminary Micro	399
14.10.1	Unlocking LM3Sxxx devices	400
14.11	NXP.....	401
14.11.1	LPC ARM7-based devices	402
14.11.2	Reset (Cortex-M3 based devices)	403
14.11.3	LPC288x flash programming	403
14.11.4	LPC43xx:	403
14.12	OKI.....	404
14.13	Renesas.....	405
14.14	Samsung	406

14.14.1	S3FN60D	406
14.15	Silicon Labs	407
14.15.1	EFM32 series devices	407
14.16	ST Microelectronics	408
14.16.1	STR91x	409
14.16.2	STM32F10xxx	409
14.16.3	STM32F2xxx	411
14.16.4	STM32F4xxx	412
14.17	Texas Instruments	413
14.17.1	AM335x	413
14.17.2	AM35xx / AM37xx	414
14.17.3	OMAP4430	414
14.17.4	OMAP-L138	414
14.17.5	TMS470M	414
14.17.6	OMAP3530	415
14.17.7	OMAP3550	415
14.18	Toshiba	416
15	Target interfaces and adapters	417
15.1	20-pin J-Link connector	418
15.1.1	Pinout for JTAG	418
15.1.2	Pinout for SWD	421
15.1.3	Pinout for SWD + Virtual COM Port (VCOM)	423
15.1.4	Pinout for SPI	424
15.2	38-pin Mictor JTAG and Trace connector	425
15.2.1	Connecting the target board	425
15.2.2	Pinout	426
15.2.3	Assignment of trace information pins between ETM architecture versions	428
15.2.4	Trace signals	428
15.3	19-pin JTAG/SWD and Trace connector	430
15.3.1	Target power supply	431
15.4	9-pin JTAG/SWD connector	432
15.5	Reference voltage (VTref)	433
15.6	Adapters	434
16	Background information	435
16.1	JTAG	436
16.1.1	Test access port (TAP)	436
16.1.2	Data registers	436
16.1.3	Instruction register	436
16.1.4	The TAP controller	437
16.2	Embedded Trace Macrocell (ETM)	439
16.2.1	Trigger condition	439
16.2.2	Code tracing and data tracing	439
16.2.3	J-Trace integration example - IAR Embedded Workbench for ARM	439
16.3	Embedded Trace Buffer (ETB)	443
16.4	Flash programming	444
16.4.1	How does flash programming via J-Link / J-Trace work?	444
16.4.2	Data download to RAM	444
16.4.3	Data download via DCC	444
16.4.4	Available options for flash programming	444
16.5	J-Link / J-Trace firmware	446
16.5.1	Firmware update	446
16.5.2	Invalidating the firmware	446
17	Designing the target board for trace	449
17.1	Overview of high-speed board design	450
17.1.1	Avoiding stubs	450
17.1.2	Minimizing Signal Skew (Balancing PCB Track Lengths)	450
17.1.3	Minimizing Crosstalk	450

17.1.4	Using impedance matching and termination	450
17.2	Terminating the trace signal	451
17.2.1	Rules for series terminators	451
17.3	Signal requirements	452
18	Semihosting	453
18.1	Introduction	454
18.1.1	Advantages	454
18.1.2	Disadvantages	454
18.2	Debugger support	455
18.3	Implementation	456
18.3.1	SVC instruction	456
18.3.2	Breakpoint instruction.....	456
18.3.3	J-Link GDBServer optimized version	456
18.4	Communication protocol.....	458
18.4.1	Register R0	458
18.4.2	Command SYS_OPEN (0x01)	458
18.4.3	Command SYS_CLOSE (0x02)	459
18.4.4	Command SYS_WRITEC (0x03).....	459
18.4.5	Command SYS_WRITE0 (0x04).....	459
18.4.6	Command SYS_WRITE (0x05)	459
18.4.7	Command SYS_READ (0x06)	460
18.4.8	Command SYS_READC (0x07)	460
18.4.9	Command SYS_ISTTY (0x09).....	460
18.4.10	Command SYS_SEEK (0x0A)	461
18.4.11	Command SYS_FLEN (0x0C).....	461
18.4.12	Command SYS_REMOVE (0x0E)	461
18.4.13	Command SYS_RENAME (0x0F)	461
18.4.14	Command SYS_GET_CMDLINE (0x15).....	462
18.4.15	Command SYS_EXIT (0x18)	462
18.5	Enabling semihosting in J-Link GDBServer	463
18.5.1	SVC variant	463
18.5.2	Breakpoint variant.....	463
18.5.3	J-Link GDBServer optimized variant.....	463
18.6	Enabling Semihosting in J-Link RDI + AXD.....	464
19	Support and FAQs	465
19.1	Measuring download speed	466
19.1.1	Test environment	466
19.2	Troubleshooting	467
19.2.1	General procedure.....	467
19.2.2	Typical problem scenarios	467
19.3	Contacting support.....	469
19.4	Frequently Asked Questions.....	470
20	Glossary.....	471
21	Literature and references.....	477

Chapter 1

Introduction

This chapter gives a short overview about J-Link and J-Trace.

1.1 Requirements

Host System

To use J-Link or J-Trace you need a host system running Windows 2000 or later. For a list of all operating systems which are supported by J-Link, please refer to *Supported OS* on page 27.

Target System

A target system with a supported CPU is required. You should make sure that the emulator you are looking at supports your target CPU. For more information about which J-Link features are supported by each emulator, please refer to *Model comparison* on page 29.

1.2 Supported OS

J-Link/J-Trace can be used on the following operating systems:

- Microsoft Windows 2000
- Microsoft Windows XP
- Microsoft Windows XP x64
- Microsoft Windows Vista
- Microsoft Windows Vista x64
- Windows 7
- Windows 7 x64
- Windows 8
- Windows 8 x64
- Windows 10
- Linux
- Mac OSX 10.5 and higher

1.3 J-Link / J-Trace models

J-Link / J-Trace is available in different variations, each designed for different purposes / target devices. Currently, the following models of J-Link / J-Trace are available:

- J-Link BASE
- J-Link PLUS
- J-Link PRO
- J-Link ULTRA+
- J-Trace ARM
- J-Trace for Cortex-M

In the following, the different J-Link / J-Trace models are described and the changes between the different hardware versions of each model are listed. To determine the hardware version of your J-Link / J-Trace, the first step should be to look at the label at the bottom side of the unit. J-Links / J-Traces have the hardware version printed on the back label.

If this is not the case with your J-Link / J-Trace, start `JLink.exe`. As part of the initial message, the hardware version is displayed.

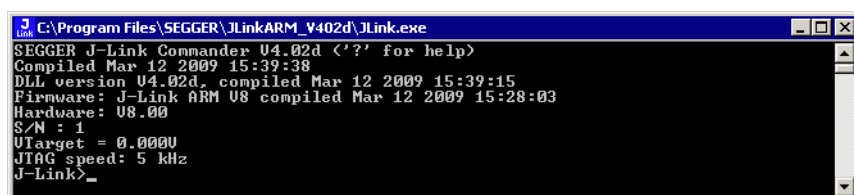

```
C:\Program Files\SEGGER\JLinkARM_V402d\JLink.exe
SEGGER J-Link Commander V4.02d ('?' for help)
Compiled Mar 12 2009 15:39:38
DLL version V4.02d, compiled Mar 12 2009 15:39:15
Firmware: J-Link ARM V8 compiled Mar 12 2009 15:28:03
Hardware: V8.00
S/N : 1
VTarget = 0.0000
JTAG speed: 5 kHz
J-Link>_
```

1.3.1 Model comparison

The following tables show the features which are included in each J-Link / J-Trace model.

Hardware features

	J-Link BASE	J-Link PLUS	J-Link ULTRA+	J-Link PRO	J-Trace for Cortex-M	J-Trace ARM
USB	yes	yes	yes	yes	yes	yes
Ethernet	no	no	no	yes	no	no
Supported cores	ARM7/9/11, Cortex-A5/A8/A9/R4, Cortex-M0/M0+/M1/M3/M4, Renesas RX				Tracing: Cortex-M3/M4 No tracing: ARM7/9/11, Cortex-M0/M0+/ M1 Cortex-A5/A8/ A9/R4	ARM 7/9
JTAG	yes	yes	yes	yes	yes	yes
SWD	yes	yes	yes	yes	yes	no
SWO	yes	yes	yes	yes	yes	no
ETM Trace	no	no	no	no	yes	yes

Software features

Software features are features implemented in the software running on the host. Software features can either come with the J-Link or be added later using a license string from Segger.

	J-Link BASE	J-Link PLUS	J-Link ULTRA+	J-Link PRO	J-Trace for Cortex-M	J-Trace ARM
J-Flash	yes(opt)	yes	yes	yes	yes	yes
Flash breakpoints ¹	yes(opt)	yes	yes	yes	yes	yes
Flash download ²	yes	yes	yes	yes	yes	yes
GDB Server	yes	yes	yes	yes	yes	yes
RDI	yes(opt)	yes	yes	yes	yes	yes

¹ In order to use the flash breakpoints with J-Link no additional license for flash download is required. The flash breakpoint feature allows setting an unlimited number of breakpoints even if the application program is not located in RAM, but in flash memory. Without this feature, the number of breakpoints which can be set in flash is limited to the number of hardware breakpoints (typically two for ARM 7/9, up to six for Cortex-M) For more information about flash breakpoints, please refer to *Flash breakpoints* on page 273.

² Most IDEs come with its own flashloaders, so in most cases this feature is not essential for debugging applications in flash. The J-Link flash download feature is mainly used in debug environments where the debugger does not come with an own flashloader (for example, the GNU Debugger). For more information about how flash download via FlashDL works, please refer to *Flash download* on page 257.

1.3.2 J-Link BASE

J-Link BASE is a JTAG emulator designed for ARM cores. It connects via USB to a PC running Microsoft Windows 2000 or later. For a complete list of all operating systems which are supported, please refer to *Supported OS* on page 27. J-Link BASE has a built-in 20-pin JTAG connector, which is compatible with the standard 20-pin connector defined by ARM.

1.3.2.1 Additional features

- Direct download into flash memory of most popular micro-controllers supported
- Full-speed USB 2.0 interface
- Serial Wire Debug supported
- Serial Wire Viewer supported
- Download speed up to 1 MBytes/second*
- Debug interface (JTAG/SWD/...) speed up to 15 MHz
- RDI interface available, which allows using J-Link with RDI compliant software

*The actual speed depends on various factors, such as JTAG/SWD, clock speed, host CPU core etc.



1.3.2.2 Specifications

The following table gives an overview about the specifications (general, mechanical, electrical) for J-Link BASE.

General	
Supported OS	For a complete list of all operating systems which are supported, please refer to <i>Supported OS</i> on page 27.
Electromagnetic compatibility (EMC)	EN 55022, EN 55024
Operating temperature	+5°C ... +60°C
Storage temperature	-20°C ... +65 °C
Relative humidity (non-condensing)	Max. 90% rH
Mechanical	
Size (without cables)	100mm x 53mm x 27mm
Weight (without cables)	70g
Available interfaces	
USB interface	USB 2.0, full speed
Target interface	JTAG 20-pin (14-pin adapter available)
JTAG/SWD Interface, Electrical	
Power supply	USB powered Max. 50mA + Target Supply current.
Target interface voltage (V_{IF})	1.2V ... 5V
Target supply voltage	4.5V ... 5V (if powered with 5V on USB)
Target supply current	Max. 300mA
Reset Type	Open drain. Can be pulled low or tristated.
Reset low level output voltage (V_{OL})	$V_{OL} \leq 10\%$ of V_{IF}
For the whole target voltage range ($1.2V \leq V_{IF} \leq 5V$)	
LOW level input voltage (V_{IL})	$V_{IL} \leq 40\%$ of V_{IF}

Table 1.1: J-Link specifications

HIGH level input voltage (V_{IH})	$V_{IH} \geq 60\%$ of V_{IF}
For $1.8V \leq V_{IF} \leq 3.6V$	
LOW level output voltage (V_{OL}) with a load of 10 kOhm	$V_{OL} \leq 10\%$ of V_{IF}
HIGH level output voltage (V_{OH}) with a load of 10 kOhm	$V_{OH} \geq 90\%$ of V_{IF}
For $3.6 \leq V_{IF} \leq 5V$	
LOW level output voltage (V_{OL}) with a load of 10 kOhm	$V_{OL} \leq 20\%$ of V_{IF}
HIGH level output voltage (V_{OH}) with a load of 10 kOhm	$V_{OH} \geq 80\%$ of V_{IF}
JTAG/SWD Interface, Timing	
SWO sampling frequency	Max. 7.5 MHz
Data input rise time (T_{rdi})	$T_{rdi} \leq 20ns$
Data input fall time (T_{fdi})	$T_{fdi} \leq 20ns$
Data output rise time (T_{rdo})	$T_{rdo} \leq 10ns$
Data output fall time (T_{fdo})	$T_{fdo} \leq 10ns$
Clock rise time (T_{rc})	$T_{rc} \leq 3ns$
Clock fall time (T_{fc})	$T_{fc} \leq 3ns$

Table 1.1: J-Link specifications

1.3.2.3 Hardware versions

Versions 1-4 (Obsolete)

Obsolete.

Version 5.0 (Obsolete)

Identical to version 4.0 with the following exception:

- Uses a 32-bit RISC CPU.
- Maximum download speed (using DCC) is over 700 Kbytes/second.
- JTAG speed: Maximum JTAG frequency is 12 MHz; possible JTAG speeds are: 48 MHz / n, where n is 4, 5, ..., resulting in speeds of:
 - 12.000 MHz (n = 4)
 - 9.600 MHz (n = 5)
 - 8.000 MHz (n = 6)
 - 6.857 MHz (n = 7)
 - 6.000 MHz (n = 8)
 - 5.333 MHz (n = 9)
 - 4.800 MHz (n = 10)
- Supports adaptive clocking.

Version 5.2 (Obsolete)

Identical to version 5.0 with the following exception:

- Target interface: RESET is open drain.

Version 5.3 (Obsolete)

Identical to version 5.2 with the following exception:

- 5V target supply current limited
5V target supply (pin 19) of Kick-Start versions of J-Link is current monitored and limited. J-Link automatically switches off 5V supply in case of over-current to protect both J-Link and host computer. Peak current (≤ 10 ms) limit is 1A, operating current limit is 300mA.

Version 5.4 (Obsolete)

Identical to version 5.3 with the following exception:

- Supports 5V target interfaces.

Version 6.0 (Obsolete)

Identical to version 5.4 with the following exception:

- Outputs can be tristated (Effectively disabling the JTAG interface)
- Supports SWD interface.
- SWD speed: Software implementation. 4 MHz maximum SWD speed.
- J-Link supports SWV (Speed limited to 500 kHz)

Version 7.0 (Obsolete)

Identical to version 6.0 with the following exception:

- Uses an additional pin to the UART unit of the target hardware for SWV support (Speed limited to 6 MHz).

Version 8.0

Identical to version 7.0 with the following exception:

- SWD support for non-3.3V targets.

Version 9.1

- New design based on STM32F205.

Version 9.2

Identical to version 9.1 with the following exception:

- Pin 1 (VTref) is used for measuring target reference voltage only. Buffers on J-Link side are no longer powered through this pin but via the J-Link internal voltage supplied via USB.

Hardware version	3.0	4.0	5.0	5.2	5.3	5.4	6.0	7.0	8.0	9.1	9.2
Hardware features											
USB	✓	✓	✓	✓	✓	✓	✓	✓	✓	✓	✓
JTAG interface	✓	✓	✓	✓	✓	✓	✓	✓	✓	✓	✓
SWD interface	✗	✗	✗	✗	✗	✗	✓	✓	✓	✓	✓
SWO interface	✗	✗	✗	✗	✗	✗	✓	✓	✓	✓	✓
Microchip ICSP interface	✗	✗	✗	✗	✗	✗	✗	✗	✗	✓	✓
Renesas FINE interface	✗	✗	✗	✗	✗	✗	✗	✗	✗	✓	✓

Table 1.2: J-Link BASE hardware versions

Hardware version	3.0	4.0	5.0	5.2	5.3	5.4	6.0	7.0	8.0	9.1	9.2
ETB Trace	✓	✓	✓	✓	✓	✓	✓	✓	✓	✓	✓
Supported cores											
ARM legacy cores											
ARM7	✓	✓	✓	✓	✓	✓	✓	✓	✓	✓	✓
ARM9	✓	✓	✓	✓	✓	✓	✓	✓	✓	✓	✓
ARM11	✗	✗	✗	✗	✗	✗	✓	✓	✓	✓	✓
ARM Cortex cores											
Cortex-A5	✗	✗	✗	✗	✗	✗	✗	✗	✗	✓	✓
Cortex-A7	✗	✗	✗	✗	✗	✗	✗	✗	✗	✓	✓
Cortex-A8	✗	✗	✗	✗	✗	✗	✗	✗	✓	✓	✓
Cortex-A9	✗	✗	✗	✗	✗	✗	✗	✗	✗	✓	✓
Cortex-A12	✗	✗	✗	✗	✗	✗	✗	✗	✗	✓	✓
Cortex-A15	✗	✗	✗	✗	✗	✗	✗	✗	✗	✓	✓
Cortex-A17	✗	✗	✗	✗	✗	✗	✗	✗	✗	✓	✓
Cortex-M0	✗	✗	✗	✗	✗	✗	✗	✗	✓	✓	✓
Cortex-M0+	✗	✗	✗	✗	✗	✗	✗	✗	✓	✓	✓
Cortex-M1	✗	✗	✗	✗	✗	✗	✗	✗	✓	✓	✓

Table 1.2: J-Link BASE hardware versions

Hardware version	3.0	4.0	5.0	5.2	5.3	5.4	6.0	7.0	8.0	9.1	9.2
Cortex-M3	✗	✗	✗	✗	✗	✗	✗	✗	✓	✓	✓
Cortex-M4	✗	✗	✗	✗	✗	✗	✗	✗	✗	✓	✓
Cortex-M7	✗	✗	✗	✗	✗	✗	✗	✗	✗	✓	✓
Cortex-R4	✗	✗	✗	✗	✗	✗	✗	✗	✓	✓	✓
Cortex-R5	✗	✗	✗	✗	✗	✗	✗	✗	✓	✓	✓
SC000 (M0 secure)	✗	✗	✗	✗	✗	✗	✗	✗	✓	✓	✓
SC300 (M3 secure)	✗	✗	✗	✗	✗	✗	✗	✗	✓	✓	✓
Microchip PIC32											
Microchip PIC32MX	✗	✗	✗	✗	✗	✗	✗	✗	✗	✓	✓
Microchip PIC32MZ	✗	✗	✗	✗	✗	✗	✗	✗	✗	✓	✓
Renesas RX											
Renesas RX110	✗	✗	✗	✗	✗	✗	✗	✗	✗	✓	✓
Renesas RX111	✗	✗	✗	✗	✗	✗	✗	✗	✗	✓	✓
Renesas RX210	✗	✗	✗	✗	✗	✗	✗	✗	✗	✓	✓
Renesas RX21A	✗	✗	✗	✗	✗	✗	✗	✗	✗	✓	✓
Renesas RX220	✗	✗	✗	✗	✗	✗	✗	✗	✗	✓	✓

Table 1.2: J-Link BASE hardware versions

Hardware version	3.0	4.0	5.0	5.2	5.3	5.4	6.0	7.0	8.0	9.1	9.2
Renesas RX610	✗	✗	✗	✗	✗	✗	✗	✗	✓	✓	✓
Renesas RX621	✗	✗	✗	✗	✗	✗	✗	✗	✓	✓	✓
Renesas RX62G	✗	✗	✗	✗	✗	✗	✗	✗	✓	✓	✓
Renesas RX62N	✗	✗	✗	✗	✗	✗	✗	✗	✓	✓	✓
Renesas RX62T	✗	✗	✗	✗	✗	✗	✗	✗	✓	✓	✓
Renesas RX630	✗	✗	✗	✗	✗	✗	✗	✗	✓	✓	✓
Renesas RX631	✗	✗	✗	✗	✗	✗	✗	✗	✓	✓	✓
Renesas RX63N	✗	✗	✗	✗	✗	✗	✗	✗	✓	✓	✓
Renesas RX63T	✗	✗	✗	✗	✗	✗	✗	✗	✓	✓	✓

Table 1.2: J-Link BASE hardware versions

1.3.3 J-Link PLUS

J-Link PLUS is a JTAG emulator designed for ARM cores. It connects via USB to a PC running Microsoft Windows 2000 or later. For a complete list of all operating systems which are supported, please refer to *Supported OS* on page 27. J-Link PLUS has a built-in 20-pin JTAG connector, which is compatible with the standard 20-pin connector defined by ARM. J-Link PLUS comes with licenses for all J-Link related SEGGER software.



1.3.3.1 Additional features

- Direct download into flash memory of most popular micro-controllers supported
- Full-speed USB 2.0 interface
- Serial Wire Debug supported
- Serial Wire Viewer supported
- Download speed up to 1 MBytes/second*
- Debug interface (JTAG/SWD/...) speed up to 15 MHz
- RDI interface available, which allows using J-Link with RDI compliant software
- Comes with built-in licenses for: Unlimited number of breakpoints in flash (FlashBP), J-Link GDBServer, J-Link RDI, J-Link RDDI and J-Flash (production programming software).

*The actual speed depends on various factors, such as JTAG/SWD, clock speed, host CPU core etc.

1.3.3.2 Specifications

The following table gives an overview about the specifications (general, mechanical, electrical) for J-Link PLUS.

General	
Supported OS	For a complete list of all operating systems which are supported, please refer to <i>Supported OS</i> on page 27.
Electromagnetic compatibility (EMC)	EN 55022, EN 55024
Operating temperature	+5°C ... +60°C
Storage temperature	-20°C ... +65 °C
Relative humidity (non-condensing)	Max. 90% rH
Mechanical	
Size (without cables)	100mm x 53mm x 27mm
Weight (without cables)	70g
Available interfaces	
USB interface	USB 2.0, full speed
Target interface	JTAG 20-pin (14-pin adapter available)
JTAG/SWD Interface, Electrical	
Power supply	USB powered Max. 50mA + Target Supply current.
Target interface voltage (V_{IF})	1.2V ... 5V
Target supply voltage	4.5V ... 5V (if powered with 5V on USB)
Target supply current	Max. 300mA
Reset Type	Open drain. Can be pulled low or tristated.

Table 1.3: J-Link specifications

Reset low level output voltage (V_{OL})	$V_{OL} \leq 10\%$ of V_{IF}
For the whole target voltage range ($1.2V \leq V_{IF} \leq 5V$)	
LOW level input voltage (V_{IL})	$V_{IL} \leq 40\%$ of V_{IF}
HIGH level input voltage (V_{IH})	$V_{IH} \geq 60\%$ of V_{IF}
For $1.8V \leq V_{IF} \leq 3.6V$	
LOW level output voltage (V_{OL}) with a load of 10 kOhm	$V_{OL} \leq 10\%$ of V_{IF}
HIGH level output voltage (V_{OH}) with a load of 10 kOhm	$V_{OH} \geq 90\%$ of V_{IF}
For $3.6 \leq V_{IF} \leq 5V$	
LOW level output voltage (V_{OL}) with a load of 10 kOhm	$V_{OL} \leq 20\%$ of V_{IF}
HIGH level output voltage (V_{OH}) with a load of 10 kOhm	$V_{OH} \geq 80\%$ of V_{IF}
JTAG/SWD Interface, Timing	
SWO sampling frequency	Max. 7.5 MHz
Data input rise time (T_{rdi})	$T_{rdi} \leq 20ns$
Data input fall time (T_{fdi})	$T_{fdi} \leq 20ns$
Data output rise time (T_{rdo})	$T_{rdo} \leq 10ns$
Data output fall time (T_{fdo})	$T_{fdo} \leq 10ns$
Clock rise time (T_{rc})	$T_{rc} \leq 3ns$
Clock fall time (T_{fc})	$T_{fc} \leq 3ns$

Table 1.3: J-Link specifications

1.3.3.3 Hardware versions

Version 9.1

- Initial design based on STM32F205.

Version 9.2

Identical to version 9.1 with the following exception:

- Pin 1 (VTref) is used for measuring target reference voltage only. Buffers on J-Link side are no longer powered through this pin but via the J-Link internal voltage supplied via USB.







Hardware version	9.1	9.2
Hardware features		
USB		
JTAG interface		
SWD interface		

Table 1.4: J-Link PLUS hardware versions





























Hardware version	9.1	9.2
SWO interface		
Microchip ICSP interface		
Renesas FINE interface		
ETB Trace		
Supported cores		
ARM legacy cores		
ARM7		
ARM9		
ARM11		
ARM Cortex cores		
Cortex-A5		
Cortex-A7		
Cortex-A8		
Cortex-A9		
Cortex-A12		
Cortex-A15		
Cortex-A17		

Table 1.4: J-Link PLUS hardware versions

Hardware version	9.1	9.2
Cortex-M0	✓	✓
Cortex-M0+	✓	✓
Cortex-M1	✓	✓
Cortex-M3	✓	✓
Cortex-M4	✓	✓
Cortex-M7	✓	✓
Cortex-R4	✓	✓
Cortex-R5	✓	✓
SC000 (M0 secure)	✓	✓
SC300 (M3 secure)	✓	✓
Microchip PIC32		
Microchip PIC32MX	✓	✓
Microchip PIC32MZ	✓	✓
Renesas RX		
Renesas RX110	✓	✓
Renesas RX111	✓	✓

Table 1.4: J-Link PLUS hardware versions























Hardware version	9.1	9.2
Renesas RX210		
Renesas RX21A		
Renesas RX220		
Renesas RX610		
Renesas RX621		
Renesas RX62G		
Renesas RX62N		
Renesas RX62T		
Renesas RX630		
Renesas RX631		
Renesas RX63N		
Renesas RX63T		

Table 1.4: J-Link PLUS hardware versions

1.3.4 J-Link ULTRA+

J-Link ULTRA+ is a JTAG/SWD emulator designed for ARM/Cortex and other supported CPUs. It is fully compatible to the standard J-Link and works with the same PC software. Based on the highly optimized and proven J-Link, it offers even higher speed as well as target power measurement capabilities due to the faster CPU, built-in FPGA and High speed USB interface. It connects via USB to a PC running Microsoft Windows 2000 or later. For a complete list of all operating systems which are supported, please refer to Supported OS on page 25. J-link ULTRA+ has a built-in 20-pin JTAG/SWD connector.



1.3.4.1 Additional features

- Fully compatible to the standard J-Link
- Very high performance for all supported CPU cores
- Hi-Speed USB 2.0 interface
- Download speed up to 3 MByte/second*
- Debug interface (JTAG/SWD/...) speed up to 15 MHz
- Serial Wire Debug (SWD) supported
- Serial Wire Viewer (SWV) supported
- SWO sampling frequencies up to 100 MHz
- Serial Wire Output (SWO) supported
- Target power can be supplied
- Comes with built-in licenses for: Unlimited number of breakpoints in flash (FlashBP), J-Link GDBServer, J-Link RDI, J-Link RDDI and J-Flash (production programming software).
- Target power consumption can be measured with high accuracy.

*The actual speed depends on various factors, such as JTAG/SWD, clock speed, host CPU core etc.

1.3.4.2 Specifications

The following table gives an overview about the specifications (general, mechanical, electrical) for J-link ULTRA+. All values are valid for J-link ULTRA hardware version 1.

Note: Some specifications, especially speed, are likely to be improved in the future with newer versions of the J-Link software (freely available).

General	
Supported OS	For a complete list of all operating systems which are supported, please refer to <i>Supported OS</i> on page 27.
Electromagnetic compatibility (EMC)	EN 55022, EN 55024
Operating temperature	+5°C ... +60°C
Storage temperature	-20°C ... +65 °C
Relative humidity (non-condensing)	Max. 90% rH
Mechanical	
Size (without cables)	100mm x 53mm x 27mm
Weight (without cables)	73g
Available interfaces	
USB interface	USB 2.0, Hi-Speed
Target interface	20-pin J-Link debug interface connector
JTAG/SWD Interface, Electrical	
Target interface voltage (V_{IF})	1.8V ... 5V
Target supply voltage	4.5V ... 5V

Table 1.5: J-link ULTRA specifications

Target supply current	Max. 300mA
Reset Type	Open drain. Can be pulled low or tristated.
Reset low level output voltage (V_{OL})	$V_{OL} \leq 10\%$ of V_{IF}
For the whole target voltage range ($1.8V \leq V_{IF} \leq 5V$)	
LOW level input voltage (V_{IL})	$V_{IL} \leq 40\%$ of V_{IF}
HIGH level input voltage (V_{IH})	$V_{IH} \geq 60\%$ of V_{IF}
For $1.8V \leq V_{IF} \leq 3.6V$	
LOW level output voltage (V_{OL}) with a load of 10 kOhm	$V_{OL} \leq 10\%$ of V_{IF}
HIGH level output voltage (V_{OH}) with a load of 10 kOhm	$V_{OH} \geq 90\%$ of V_{IF}
For $3.6 \leq V_{IF} \leq 5V$	
LOW level output voltage (V_{OL}) with a load of 10 kOhm	$V_{OL} \leq 20\%$ of V_{IF}
HIGH level output voltage (V_{OH}) with a load of 10 kOhm	$V_{OH} \geq 80\%$ of V_{IF}
JTAG/SWD Interface, Timing	
SWO sampling frequency	Max. 100 MHz
Data input rise time (T_{rdi})	$T_{rdi} \leq 20ns$
Data input fall time (T_{fdi})	$T_{fdi} \leq 20ns$
Data output rise time (T_{rdo})	$T_{rdo} \leq 10ns$
Data output fall time (T_{fdo})	$T_{fdo} \leq 10ns$
Clock rise time (T_{rc})	$T_{rc} \leq 3ns$
Clock fall time (T_{fc})	$T_{fc} \leq 3ns$
Analog power measurement interface	
Sampling frequency	50 kHz
Resolution	1 mA

Table 1.5: J-link ULTRA specifications

1.3.4.3 Hardware versions

Version 1.1

Compatible to J-Link.

- Initial design based on ATMEL SAM3U without FPGA.

Version 4

- New design based on STM32F407 + FPGA (Cyclone IV)Version 4.3

Identical to version 4 with the following exception:

Pin 1 (VTref) is used for measuring target reference voltage only. Buffers on J-Link side are no longer powered through this pin but via the J-Link internal voltage supplied via USB.



























Hardware version	1.1	4.0
Hardware features		
USB		
JTAG interface		
SWD interface		
SWO interface		
Microchip ICSP interface		
Renesas FINE interface		
ETB Trace		
Supported cores		
ARM legacy cores		
ARM7		
ARM9		
ARM11		
ARM Cortex cores		
Cortex-A5		
Cortex-A7		
Cortex-A8		

Table 1.6: J-Link ULTRA+ hardware versions

Hardware version	1.1	4.0
Cortex-A9	✓	✓
Cortex-A12	✓	✓
Cortex-A15	✓	✓
Cortex-A17	✓	✓
Cortex-M0	✓	✓
Cortex-M0+	✓	✓
Cortex-M1	✓	✓
Cortex-M3	✓	✓
Cortex-M4	✓	✓
Cortex-M7	✗	✓
Cortex-R4	✓	✓
Cortex-R5	✓	✓
SC000 (M0 secure)	✓	✓
SC300 (M3 secure)	✓	✓
Microchip PIC32		
Microchip PIC32MX	✗	✓

Table 1.6: J-Link ULTRA+ hardware versions































Hardware version	1.1	4.0
Microchip PIC32MZ		
Renesas RX		
Renesas RX110		
Renesas RX111		
Renesas RX210		
Renesas RX21A		
Renesas RX220		
Renesas RX610		
Renesas RX621		
Renesas RX62G		
Renesas RX62N		
Renesas RX62T		
Renesas RX630		
Renesas RX631		
Renesas RX63N		
Renesas RX63T		

Table 1.6: J-Link ULTRA+ hardware versions

1.3.5 J-Link PRO

J-Link PRO is a JTAG emulator designed for ARM cores. It is fully compatible to J-Link and connects via Ethernet/USB to a PC running Microsoft Windows 2000 or later, Linux or Mac OS X. For a complete list of all operating systems which are supported, please refer to Supported OS on page 25. J-Link PRO comes with licenses for all J-Link related SEGGER software.

1.3.5.1 Additional features

- Fully compatible to J-Link
- More memory for future firmware extensions (ARM11, X-Scale, Cortex R4 and Cortex A8)
- Additional LEDs for power and RESET indication
- Comes with web interface for easy TCP/IP configuration (built-in web server)
- Serial Wire Debug supported
- Serial Wire Viewer supported
- Download speed up to 3 MByte/second
- Comes with built-in licenses for: Unlimited number of breakpoints in flash (FlashBP), J-Link GDBServer, J-Link RDI, J-Link RDDI and J-Flash (production programming software).
- Embedded Trace Buffer (ETB) support
- Galvanic isolation from host via Ethernet



1.3.5.2 Hardware versions

Version 1.1

Compatible to J-Link.

- Provides an additional Ethernet interface which allows to communicate with J-Link via TCP/IP.

Version 3

Identical to version 1.1 with the following exception:

- SWD support for non-3.3V targets.

Version 4

- New design based on STM32F407 + FPGA (Cyclone IV) Version 4.3

Identical to version 4 with the following exception:

- Pin 1 (VTref) is used for measuring target reference voltage only. Buffers on J-Link side are no longer powered through this pin but via the J-Link internal voltage supplied via USB.

Hardware version	1.1	3.0	4.0
Hardware features			
USB	✓	✓	✓
Ethernet	✓	✓	✓
JTAG interface	✓	✓	✓

Table 1.7: J-Link PRO hardware versions

Hardware version	1.1	3.0	4.0
SWD interface	✓	✓	✓
SWO interface	✓	✓	✓
Microchip ICSP interface	✗	✗	✓
Renesas FINE interface	✗	✗	✓
ETB Trace	✓	✓	✓
Supported cores			
ARM legacy cores			
ARM7	✓	✓	✓
ARM9	✓	✓	✓
ARM11	✓	✓	✓
ARM Cortex cores			
Cortex-A5	✗	✓	✓
Cortex-A7	✗	✓	✓
Cortex-A8	✗	✓	✓
Cortex-A9	✗	✓	✓
Cortex-A12	✗	✓	✓
Cortex-A15	✗	✓	✓

Table 1.7: J-Link PRO hardware versions

Hardware version	1.1	3.0	4.0
Cortex-A17	✘	✔	✔
Cortex-M0	✔	✔	✔
Cortex-M0+	✔	✔	✔
Cortex-M1	✔	✔	✔
Cortex-M3	✔	✔	✔
Cortex-M4	✘	✔	✔
Cortex-M7	✘	✘	✔
Cortex-R4	✘	✔	✔
Cortex-R5	✘	✔	✔
SC000 (M0 secure)	✔	✔	✔
SC300 (M3 secure)	✔	✔	✔
Microchip PIC32			
Microchip PIC32MX	✘	✘	✔
Microchip PIC32MZ	✘	✘	✔
Renesas RX			
Renesas RX110	✘	✘	✔

Table 1.7: J-Link PRO hardware versions

Hardware version	1.1	3.0	4.0
Renesas RX111	✘	✘	✔
Renesas RX210	✘	✘	✔
Renesas RX21A	✘	✘	✔
Renesas RX220	✘	✘	✔
Renesas RX610	✘	✔	✔
Renesas RX621	✘	✔	✔
Renesas RX62G	✘	✔	✔
Renesas RX62N	✘	✔	✔
Renesas RX62T	✘	✔	✔
Renesas RX630	✘	✔	✔
Renesas RX631	✘	✔	✔
Renesas RX63N	✘	✔	✔
Renesas RX63T	✘	✔	✔

Table 1.7: J-Link PRO hardware versions

1.3.6 J-Link Lite ARM

J-Link Lite ARM is a fully functional OEM-version of J-Link. If you are selling evaluation-boards, J-Link Lite ARM is an inexpensive emulator solution for you. Your customer receives a widely acknowledged debug probe which allows to start right away with development.



1.3.6.1 Additional features

- Very small form factor
- Fully software compatible to J-Link
- Supports any ARM7/9/11, Cortex-A5/A8/A9, Cortex-M0/M0+/M1/M3/M4, Cortex-R4/R5 core
- JTAG clock up to 4 MHz
- SWD, SWO supported for Cortex-M devices
- Flash download into supported MCUs
- Standard 20-pin 0.1 inch JTAG connector (compatible to J-Link)

1.3.6.2 Specifications

The following table gives an overview about the specifications (general, mechanical, electrical) for J-Link Lite ARM. All values are valid for J-Link hardware version 8.

General	
Supported OS	For a complete list of all operating systems which are supported, please refer to <i>Supported OS</i> on page 27.
Electromagnetic compatibility (EMC)	EN 55022, EN 55024
Operating temperature	+5°C ... +60°C
Storage temperature	-20°C ... +65 °C
Relative humidity (non-condensing)	Max. 90% rH
Size (without cables)	28mm x 26mm x 7mm
Weight (without cables)	6g
Mechanical	
USB interface	USB 2.0, full speed
Target interface	JTAG 20-pin (14-pin adapter available)
JTAG/SWD Interface, Electrical	
Power supply	USB powered Max. 50mA + Target Supply current.
Target interface voltage (V_{IF})	3.3V
Target supply voltage	4.5V ... 5V (if powered with 5V on USB)
Target supply current	Max. 300mA
LOW level input voltage (V_{IL})	Max. 40% of V_{IF}
HIGH level input voltage (V_{IH})	Min. 60% of V_{IF}
JTAG/SWD Interface, Timing	
Data input rise time (T_{rdi})	Max. 20ns
Data input fall time (T_{fdi})	Max. 20ns
Data output rise time (T_{rdo})	Max. 10ns
Data output fall time (T_{fdo})	Max. 10ns
Clock rise time (T_{rc})	Max. 10ns
Clock fall time (T_{fc})	Max. 10ns

Table 1.8: J-Link Lite specifications

1.3.7 J-Link Lite CortexM

J-Link Lite CortexM is a specific OEM-version of SEGGER J-Link Lite which is designed to be used with Cortex-M devices. If you are selling evaluation-boards, J-Link Lite CortexM is an inexpensive emulator solution for you. Your customer receives a widely acknowledged JTAG/SWD-emulator which allows to start right away with development.



- Very small form factor
- Fully software compatible to J-Link
- Any Cortex-M0/M0+/M1/M3/M4 core supported
- JTAG clock up to 4 MHz
- SWD, SWO supported
- Flash download into supported MCUs
- Standard 9- or 19-pin 0.05" Samtec FTSH connector
- 3.3V target interface voltage

1.3.7.1 Specifications

The following table gives an overview about the specifications (general, mechanical, electrical) for J-Link Lite Cortex-M.

General	
Supported OS	For a complete list of all operating systems which are supported, please refer to <i>Supported OS</i> on page 27.
Electromagnetic compatibility (EMC)	EN 55022, EN 55024
Operating temperature	+5°C ... +60°C
Storage temperature	-20°C ... +65 °C
Relative humidity (non-condensing)	Max. 90% rH
Size (without cables)	41mm x 34mm x 8mm
Weight (without cables)	6g
Mechanical	
USB interface	USB 2.0, full speed
Target interface	19-pin 0.05" Samtec FTSH connector 9-pin 0.05" Samtec FTSH connector
JTAG/SWD Interface, Electrical	
Power supply	USB powered Max. 50mA + Target Supply current.
Target interface voltage (V_{IF})	3.3V
Target supply voltage	4.5V ... 5V
Target supply current	Max. 300mA
LOW level input voltage (V_{IL})	Max. 40% of V_{IF}
HIGH level input voltage (V_{IH})	Min. 60% of V_{IF}
JTAG/SWD Interface, Timing	
Data input rise time (T_{rdi})	Max. 20ns
Data input fall time (T_{fdi})	Max. 20ns
Data output rise time (T_{rdo})	Max. 10ns
Data output fall time (T_{fdo})	Max. 10ns
Clock rise time (T_{rc})	Max. 10ns
Clock fall time (T_{fc})	Max. 10ns

Table 1.9: J-Link Lite Cortex-M specifications

1.3.8 J-Trace ARM

J-Trace ARM is a JTAG emulator designed for ARM cores which includes trace (ETM) support. It connects via USB to a PC running Microsoft Windows 2000 or later. For a complete list of all operating systems which are supported, please refer to Supported OS on page 25. J-Trace has a built-in 20-pin JTAG connector and a built in 38-pin JTAG+Trace connector, which are compatible to the standard 20-pin connector and 38-pin connector defined by ARM.



1.3.8.1 Additional features

- Supports tracing on ARM7/9 targets
- JTAG speed up to 12 MHz
- Download speed up to 420 Kbytes/second *
- DCC speed up to 600 Kbytes/second *
- Comes with built-in licenses for: Unlimited number of breakpoints in flash (FlashBP), J-Link GDBServer, J-Link RDI, J-Link RDDI and J-Flash (production programming software).

* Measured with J-Trace, ARM7 @ 50 MHz, 12MHz JTAG speed.

1.3.8.2 Specifications

General	
Supported OS	For a complete list of all operating systems which are supported, please refer to <i>Supported OS</i> on page 27.
Electromagnetic Compatibility (EMC)	EN 55022, EN 55024
Operating Temperature	+5°C ... +40°C
Storage Temperature	-20°C ... +65 °C
Relative Humidity (non-condensing)	<90% rH
Size (without cables)	123mm x 68mm x 30mm
Weight (without cables)	120g
Mechanical	
USB Interface	USB 2.0, full speed
Target Interface	JTAG 20-pin (14-pin adapter available) JTAG+Trace: Mictor, 38-pin
JTAG/SWD Interface, Electrical	
Power Supply	USB powered < 300mA
Supported Target interface voltage	3.0 - 3.6 V (5V adapter available)

Table 1.10: J-Trace specifications

1.3.8.3 Download speed

The following table lists performance values (Kbytes/s) for writing to memory (RAM):

Hardware	ARM7 via JTAG	ARM9 via JTAG
J-Trace Rev. 1	420.0 Kbytes/s (12MHz JTAG)	280.0 Kbytes/s (12MHz JTAG)

Table 1.11: Download speed differences between hardware revisions

All tests have been performed in the testing environment which is described on *Measuring download speed* on page 466.

The actual speed depends on various factors, such as JTAG, clock speed, host CPU core etc.

1.3.8.4 Hardware versions

Version 1

This J-Trace uses a 32-bit RISC CPU. Maximum download speed is approximately 420 KBytes/second (600 KBytes/second using DCC).

1.3.9 J-Trace for Cortex-M

J-Trace for Cortex-M is a JTAG/SWD emulator designed for Cortex-M cores which includes trace (ETM) support. J-Trace for Cortex-M can also be used as a J-Link and it also supports ARM7/9 cores. Tracing on ARM7/9 targets is not supported.



1.3.9.1 Additional features

- Has all the J-Link functionality
- Supports tracing on Cortex-M targets
- Comes with built-in licenses for: Unlimited number of breakpoints in flash (FlashBP), J-Link GDBServer, J-Link RDI, J-Link RDDI and J-Flash (production programming software).

1.3.9.2 Specifications

The following table gives an overview about the specifications (general, mechanical, electrical) for J-Trace for Cortex-M. All values are valid for the latest hardware version of J-Trace for Cortex-M.

General	
Supported OS	For a complete list of all operating systems which are supported, please refer to Supported OS on page 19.
Electromagnetic compatibility (EMC)	EN 55022, EN 55024
Operating temperature	+5°C ... +60°C
Storage temperature	-20°C ... +65 °C
Relative humidity (non-condensing)	Max. 90% rH
Size (without cables)	123mm x 68mm x 30mm
Weight (without cables)	120g
Mechanical	
USB interface	USB 2.0, Hi-Speed
Target interface	JTAG/SWD 20-pin (14-pin adapter available) JTAG/SWD + Trace 19-pin
JTAG/SWD Interface, Electrical	
Power supply	USB powered Max. 50mA + Target Supply current.
Target interface voltage (V_{IF})	1.2V ... 5V
Target supply voltage	4.5V ... 5V (if powered with 5V on USB)
Target supply current	Max. 300mA
LOW level input voltage (V_{IL})	Max. 40% of V_{IF}
HIGH level input voltage (V_{IH})	Min. 60% of V_{IF}
JTAG/SWD Interface, Timing	
Data input rise time (T_{rdi})	Max. 20ns
Data input fall time (T_{fdi})	Max. 20ns
Data output rise time (T_{rdo})	Max. 10ns
Data output fall time (T_{fdo})	Max. 10ns

Table 1.12: J-Trace for Cortex-M3 specifications

Clock rise time (T_{rc})	Max. 3ns
Clock fall time (T_{fc})	Max. 3ns
Trace Interface, Electrical	
Power supply	USB powered Max. 50mA + Target Supply current.
Target interface voltage (V_{IF})	1.2V ... 5V
Voltage interface low pulse (V_{IL})	Max. 40% of V_{IF}
Voltage interface high pulse (V_{IH})	Min. 60% of V_{IF}
Trace Interface, Timing	
TRACECLK low pulse width (T_{wl})	Min. 2ns
TRACECLK high pulse width (T_{wh})	Min. 2ns
Data rise time (T_{rd})	Max. 3ns
Data fall time (T_{fd})	Max. 3ns
Clock rise time (T_{rc})	Max. 3ns
Clock fall time (T_{fc})	Max. 3ns
Data setup time (T_s)	Min. 3ns
Data hold time (T_h)	Min. 2ns

Table 1.12: J-Trace for Cortex-M3 specifications

1.3.9.3 Download speed

The following table lists performance values (Kbytes/s) for writing to memory (RAM):

Hardware	Cortex-M3
J-Trace for Cortex-M3 V2	190 Kbytes/s (12MHz SWD) 760 KB/s (12 MHz JTAG)
J-Trace for Cortex-M V3.1	190 Kbytes/s (12MHz SWD) 1440 KB/s (25 MHz JTAG)

Table 1.13: Download speed differences between hardware revisions

The actual speed depends on various factors, such as JTAG, clock speed, host CPU core etc.

1.3.9.4 Hardware versions

Version 2

Obsolete.

Version 3.1

Identical to version 2.0 with the following exceptions:

- Hi-Speed USB
- Voltage range for trace signals extended to 1.2 - 3.3 V
- Higher download speed

Hardware version	2	3.1
Hardware features		
USB	✓	✓
JTAG interface	✓	✓
SWD interface	✓	✓
SWO interface	✓	✓
ETM Trace	✓	✓
Supported cores		
ARM Cortex cores		
Cortex-M0	✓	✓
Cortex-M0+	✓	✓
Cortex-M1	✓	✓
Cortex-M3	✓	✓
Cortex-M4	✗	✓
Cortex-M7	✗	✓
SC000 (M0 secure)	✓	✓
SC300 (M3 secure)	✓	✓

Table 1.14: J-Trace for Cortex-M hardware versions

1.3.10 Flasher ARM

Flasher ARM is a programming tool for microcontrollers with on-chip or external Flash memory and ARM core. Flasher ARM is designed for programming flash targets with the J-Flash software or stand-alone. In addition to that Flasher ARM has all of the J-Link functionality. For more information about Flasher ARM, please refer to *UM08007, Flasher ARM User's Guide*.



1.3.10.1 Specifications

The following table gives an overview about the specifications (general, mechanical, electrical) for Flasher ARM.

General	
Supported OS	For a complete list of all operating systems which are supported, please refer to Supported OS on page 19.
Mechanical	
USB interface	USB 2.0, full speed
Target interface	JTAG/SWD 20-pin
JTAG Interface, Electrical	
Power supply	USB powered Max. 50mA + Target Supply current.
Target interface voltage (V_{IF})	1.2V ... 5V
Target supply voltage	4.5V ... 5V (if powered with 5V on USB)
Target supply current	Max. 300mA
For the whole target voltage range ($1.8V \leq V_{IF} \leq 5V$)	
LOW level input voltage (V_{IL})	Max. 40% of V_{IF}
HIGH level input voltage (V_{IH})	Min. 60% of V_{IF}
For $1.8V \leq V_{IF} \leq 3.6V$	
LOW level output voltage (V_{OL}) with a load of 10 kOhm	Max. 10% of V_{IF}
HIGH level output voltage (V_{OH}) with a load of 10 kOhm	Min. 90% of V_{IF}
For $3.6 \leq V_{IF} \leq 5V$	
LOW level output voltage (V_{OL}) with a load of 10 kOhm	Max. 20% of V_{IF}
HIGH level output voltage (V_{OH}) with a load of 10 kOhm	Min. 80% of V_{IF}
SWD Interface, Electrical	
Power supply	USB powered Max. 50mA + Target Supply current.
Target interface voltage (V_{IF})	1.2V ... 5V (SWD interface is 5V tolerant but can output a maximum of 3.3V SWD signals)
Target supply voltage	4.5V ... 5V (if powered with 5V on USB)

Table 1.15: Flasher ARM specifications

Target supply current	Max. 300mA
LOW level input voltage (V_{IL})	Max. 0.8V
HIGH level input voltage (V_{IH})	Min. 2.0V
LOW level output voltage (V_{OL}) with a load of 10 kOhm	Max. 0.5V
HIGH level output voltage (V_{OH}) with a load of 10 kOhm	Min. 2.85V

Table 1.15: Flasher ARM specifications

1.4 Common features of the J-Link product family

- USB 2.0 interface (Full-Speed/Hi-Speed, depends on J-Link model)
- Any ARM7/9/11 (including thumb mode), Cortex-A5/A8, Cortex-M0/M1/M3/M4, Cortex-R4 core supported
- Automatic core recognition
- Maximum JTAG speed 12/25 MHz (depends on J-Link model)
- Seamless integration into all major IDEs (<https://segger.com/jlink-ide-integration.html>)
- No power supply required, powered through USB
- Support for adaptive clocking
- All JTAG signals can be monitored, target voltage can be measured
- Support for multiple devices
- Fully plug and play compatible
- Standard 20-pin JTAG/SWD connector, 19-pin JTAG/SWD and Trace connector, standard 38-pin JTAG+Trace connector
- USB and 20-pin ribbon cable included
- Memory viewer (J-Mem) included
- Remote server included, which allows using J-Trace via TCP/IP networks
- RDI interface available, which allows using J-Link with RDI compliant software
- Flash programming software (J-Flash) available
- Flash DLL available, which allows using flash functionality in custom applications
- Software Developer Kit (SDK) available
- Full integration with the IAR C-SPY® debugger; advanced debugging features available from IAR C-SPY debugger.
- 14-pin JTAG adapter available
- J-Link 19-pin Cortex-M Adapter available
- J-Link 9-pin Cortex-M Adapter available
- Adapter for 5V JTAG targets available for hardware revisions up to 5.3
- Optical isolation adapter for JTAG/SWD interface available
- Target power supply via pin 19 of the JTAG/SWD interface (up to 300 mA to target with overload protection), alternatively on pins 11 and 13 of the Cortex-M 19-pin trace connector

1.5 Supported CPU cores

J-Link / J-Trace has been tested with the following cores, but should work with any ARM7/9/11, Cortex-M0/M1/M3/M4 and Cortex-A5/A8/A9/R4 core. If you experience problems with a particular core, do not hesitate to contact Segger.

- ARM7TDMI (Rev 1)
- ARM7TDMI (Rev 3)
- ARM7TDMI-S (Rev 4)
- ARM720T
- ARM920T
- ARM922T
- ARM926EJ-S
- ARM946E-S
- ARM966E-S
- ARM1136JF-S
- ARM1136J-S
- ARM1156T2-S
- ARM1156T2F-S
- ARM1176JZ-S
- ARM1176JZF
- ARM1176JZF-S
- Cortex-A5
- Cortex-A8
- Cortex-A9
- Cortex-M0
- Cortex-M1
- Cortex-M3
- Cortex-M4
- Cortex-R4
- Renesas RX

1.6 Built-in intelligence for supported CPU-cores

In general, there are two ways to support a CPU-core in the J-Link software:

1. Intelligence in the J-Link firmware
2. Intelligence on the PC-side (DLL)

Having the intelligence in the firmware is ideal since it is much more powerful and robust. The J-Link PC software automatically detects which implementation level is supported for the connected CPU-core. If intelligence in the firmware is available, it is used. If you are using a J-Link that does not have intelligence in the firmware and only PC-side intelligence is available for the connected CPU, a warning message is shown.

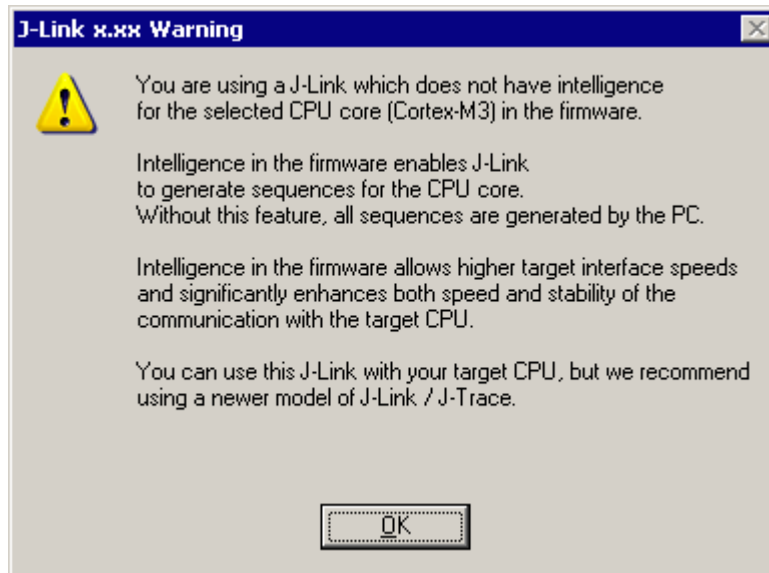

1.6.1 Intelligence in the J-Link firmware

On newer J-Links, the intelligence for a new CPU-core is also available in the J-Link firmware which means that for these J-Links, the target sequences are no longer generated on the PC-side but directly inside the J-Link. Having the intelligence in the firmware leads to improved stability and higher performance.

1.6.2 Intelligence on the PC-side (DLL)

This is the basic implementation level for support of a CPU-core. This implementation is not J-Link model dependent, since no intelligence for the CPU-core is necessary in the J-Link firmware. This means, all target sequences (JTAG/SWD/...) are generated on the PC-side and the J-Link simply sends out these sequences and sends the result back to the DLL. Using this way of implementation also allows old J-Links to be used with new CPU cores as long as a DLL-Version is used which has intelligence for the CPU.

But there is one big disadvantage of implementing the CPU core support on the DLL-side: For every sequence which shall be sent to the target a USB or Ethernet transaction is triggered. The long latency especially on a USB connection significantly affects the performance of J-Link. This is true especially when performing actions where J-Link has to wait for the CPU frequently. An example is a memory read/write operation which needs to be followed by status read operations or repeated until the memory operation is completed. Performing this kind of task with only PC-side intelligence requires to either make some assumption like: Operation is completed after a given number of cycles. Or it requires to make a lot of USB/Ethernet transactions. The first option (fast mode) will not work under some circumstances such as low CPU speeds, the second (slow mode) will be more reliable but very slow due to the high number of USB/Ethernet transactions. It simply boils down to: The best solution is having intelligence in the emulator itself!

1.6.2.1 Limitations of PC-side implementations

- **Instability, especially on slow targets**

Due to the fact that a lot of USB transactions would cause a very bad performance of J-Link, PC-side implementations are on the assumption that the CPU/Debug interface is fast enough to handle the commands/requests without the need of waiting. So, when using the PC-side-intelligence, stability cannot be guaranteed in all cases, especially if the target interface speed (JTAG/SWD/...) is significantly higher than the CPU speed.

- **Poor performance**

Since a lot more data has to be transferred over the host interface (typically USB), the resulting download speed is typically much lower than for implementations with intelligence in the firmware, even if the number of transactions over the host interface is limited to a minimum (fast mode).

- **No support**

Please understand that we cannot give any support if you are running into problems when using a PC-side implementation.

Note: Due to these limitations, we recommend to use PC-side implementations for evaluation only.

1.6.3 Firmware intelligence per model

There are different models of J-Link / J-Trace which have built-in intelligence for different CPU-cores. In the following, we will give you an overview about which model of J-Link / J-Trace has intelligence for which CPU-core.

1.6.3.1 Current models

The table below lists the firmware CPU support for J-Link & J-Trace models currently available.

J-Link / J-Trace model	Version	ARM 7/9	ARM 11	Cortex-A/R	Cortex-M		Renesas RX600
		JTAG	JTAG	JTAG	JTAG	SWD	JTAG
J-Link BASE	8	✓	✓	✓	✓	✓	✓
J-Link PRO	3	✓	✓	✓	✓	✓	✓
J-link ULTRA	1	✓	✓	✓	✓	✓	✓
J-Link Lite ARM	8	✓	✓	✓	✓	✓	✗
J-Link Lite Cortex-M	8	✗	✗	✗	✓	✓	✗
J-Link Lite RX	8	✗	✗	✗	✗	✗	✓
J-Trace ARM	1	✓	✗	✗	✗	✗	✗
J-Trace for Cortex-M	3	✗	✗	✗	✓	✓	✗

Table 1.16: Built-in intelligence of current J-Links

1.6.3.2 Older models

The table below lists the firmware CPU support for older J-Link & J-Trace models which are not sold anymore.

J-Link / J-Trace model	Version	ARM 7/9	ARM 11	Cortex-A/R	Cortex-M		Renesas RX600
		JTAG	JTAG	JTAG	JTAG	SWD	JTAG
J-Link	3	✗	✗	✗	✗	not supported	✗
J-Link	4	✗	✗	✗	✗	not supported	✗
J-Link	5	✓	✗	✗	✗	not supported	✗
J-Link	6	✓	✗	✗	✗	✓	✗
J-Link	7	✓	✗	✗	✗	✓	✗
J-Link Pro	1	✓	✓	✓	✓	✓	✓
J-Trace for Cortex-M	1	✗	✗	✓	✓	✓	✗

Table 1.17: Built-in intelligence of older J-Link models

1.7 Supported IDEs

J-Link / J-Trace can be used with different IDEs. Some IDEs support J-Link directly, for other ones additional software (such as J-Link RDI) is necessary in order to use J-Link. The following tables list which features of J-Link / J-Trace can be used with the different IDEs.

ARM7/9

IDE	Debug support ⁴	Flash download	Flash breakpoints	Trace support ³
IAR EWARM	yes	yes	yes	yes
Keil MDK	yes	yes	yes	no
Rowley	yes	yes	no	no
CodeSourcery	yes	no	no	no
Yargato (GDB)	yes	yes	yes	no
RDI compliant toolchains such as RVDS/ADS	yes ¹	yes ¹	yes ¹	no

ARM Cortex-M3

IDE	Debug support ⁴	Flash download	Flash breakpoints	Trace support ³	SWO support
IAR EWARM	yes	yes	yes	yes	yes
Keil MDK	yes	yes	yes	yes	yes
Rowley	yes	yes	no	no	no
CodeSourcery	yes	no	no	no	no
Yargato (GDB)	yes	yes	yes	no	no

ARM11

ARM11 has currently been tested with IAR EWARM only.

IDE	Debug support ⁴	Flash download	Flash breakpoints	Trace support ³
IAR EWARM	yes	no ²	no ²	no
Rowley	yes	no ²	no	no
Yargato (GDB)	yes	no ²	no ²	no

¹ Requires J-Link RDI license for download of more than 32KBytes

² Coming soon

³ Requires emulator with trace support

⁴ Debug support includes the following: Download to RAM, memory read/write, CPU register read/write, Run control (go, step, halt), software breakpoints in RAM and hardware breakpoints in flash memory.

Chapter 2

Licensing

This chapter describes the different license types of J-Link related software and the legal use of the J-Link software with original SEGGER and OEM products.

2.1 Components requiring a license

The following programs/features require a full-featured J-Link (PLUS, ULTRA+, PRO, J-Trace) or an additional license for the J-Link base model:

- J-Flash
- J-Link RDI
- J-Link Debugger
- Flash breakpoints (`FlashBP`)

2.2 License types

For each of the software components which require an additional license, there are different types of licenses which are explained in the following.

Built-in License

This type of license is easiest to use. The customer does not need to deal with a license key. The software automatically finds out that the connected J-Link contains the built-in license(s). The license is burned into the J-Link debug probe and can be used on any computer the J-Link is connected to. This type of license applies to the J-Link PLUS, J-Link ULTRA+ and J-Link Pro.

Key-based license

This type of license is used if you already have a J-Link, but order a license for a J-Link software component at a later time. In addition to that, the key-based license is used for trial licenses. To enable this type of license you need to obtain a license key from SEGGER. Free trial licenses are available upon request from www.segger.com. This license key has to be added to the J-Link license management. How to enter a license key is described in detail in *Licensing* on page 275. Every license can be used on different PCs, but only with the J-Link the license is for. This means that if you want to use flash breakpoints with other J-Links, every J-Link needs a license.

2.2.1 Built-in license

This type of license is easiest to use. The customer does not need to deal with a license key. The software automatically finds out that the connected J-Link contains the built-in license(s). To check what licenses the used J-Link have, simply open the J-Link commander (JLink.exe). The J-Link commander finds and lists all of the J-Link's licenses automatically, as can be seen in the screenshot below.

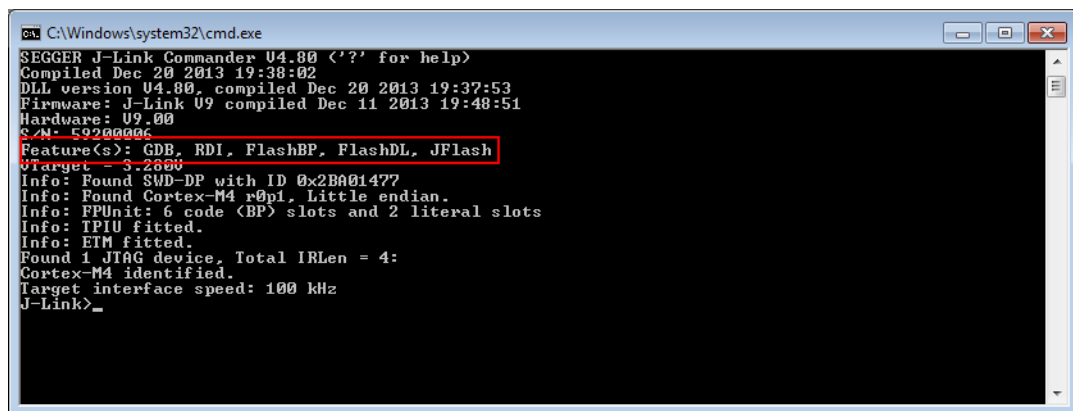

```

C:\Windows\system32\cmd.exe
SEGGER J-Link Commander V4.80 ('?' for help)
Compiled Dec 20 2013 19:38:02
DLL version V4.80, compiled Dec 20 2013 19:37:53
Firmware: J-Link V9 compiled Dec 11 2013 19:48:51
Hardware: V9_00
S/N: 59200006
Feature(s): GDB, RDI, FlashBP, FlashDL, JFlash
VTarget - S-2800
Info: Found SWD-DP with ID 0x2BA01477
Info: Found Cortex-M4 r0p1, Little endian.
Info: FPUUnit: 6 code (BP) slots and 2 literal slots
Info: TPIU fitted.
Info: ETM fitted.
Found 1 JTAG device, Total IRLen = 4:
Cortex-M4 identified.
Target interface speed: 100 kHz
J-Link>_
  
```

The J-Link PLUS in the example above contains licenses for all features. Note that GDB and FlashDL feature are no longer required.

2.2.2 Key-based license

When using a key-based license, a license key is required in order to enable the feature. License keys can be added via the J-Link License Manager. How to enter a license via the license manager is described in *Licensing* on page 275. Like the built-in license, the key-based license is only valid for one J-Link, so if another J-Link is used it needs a separate license.

2.3 Legal use of SEGGER J-Link software

The software consists of proprietary programs of SEGGER, protected under copyright and trade secret laws. All rights, title and interest in the software are and shall remain with SEGGER. For details, please refer to the license agreement which needs to be accepted when installing the software. The text of the license agreement is also available as entry in the start menu after installing the software.

Use of software

SEGGER J-Link software may only be used with original SEGGER products and authorized OEM products. The use of the licensed software to operate SEGGER product clones is prohibited and illegal.

2.3.1 Use of the software with 3rd party tools

For simplicity, some components of the J-Link software are also distributed by partners with software tools designed to use J-Link. These tools are primarily debugging tools, but also memory viewers, flash programming utilities as well as software for other purposes. Distribution of the software components is legal for our partners, but the same rules as described above apply for their usage: They may only be used with original SEGGER products and authorized OEM products. The use of the licensed software to operate SEGGER product clones is prohibited and illegal.

2.4 Original SEGGER products

All of the following SEGGER products are supported by the OSs stated in Chapter 1.2 [Supported OS](#)

The following products are original SEGGER products for which the use of the J-Link software is allowed:

2.4.1 J-Link BASE

J-Link BASE is a JTAG emulator designed for ARM cores. It connects via USB or Ethernet to a PC running Microsoft Windows, Apple OSX or Linux. J-Link BASE has a built-in 20-pin JTAG connector, which is compatible with the standard 20-pin connector defined by ARM.

Included Licenses

J-Link Flashloaders
J-Link GDB Server

Optional Licenses:

J-Link Debugger
J-Flash
Unlimited Flash Breakpoints
RDI / RDDI



2.4.2 J-Link PLUS

J-Link PLUS is a USB powered JTAG emulator supporting a large number of CPU cores.

Based on a 32-bit RISC CPU, it can communicate at high speed with the supported target CPUs. J-Link is used around the world in tens of thousand places for development and production (flash programming) purposes.

J-Link is supported by all major IDEs such as IAR EWARM, Keil MDK, Rowley CrossWorks, Atollic TrueSTUDIO, IAR EWRX, Renesas HEW, Renesas e2studio, and many others.

Included Licenses

J-Link Flashloaders
J-Link GDB Server
J-Link Debugger
J-Flash
Unlimited Flash Breakpoints
RDI / RDDI



2.4.3 J-link ULTRA+

J-link ULTRA+ is a JTAG/SWD emulator designed for ARM/Cortex and other supported CPUs. It is fully compatible to the standard J-Link and works with the same PC software. Based on the highly optimized and proven J-Link, it offers even higher speed as well as target power measurement capabilities due to the faster CPU, built-in FPGA and High speed USB interface. J-link ULTRA has a built-in 20-pin JTAG/SWD connector.

Included Licenses

- J-Link Flashloaders
- J-Link GDB Server
- J-Link Debugger
- J-Flash
- Unlimited Flash Breakpoints
- RDI / RDDI



2.4.4 J-Link PRO



J-Link PRO is a JTAG emulator designed for ARM cores. It connects via USB or Ethernet to a PC running Microsoft Windows, Apple OSX or Linux. J-Link has a built-in 20-pin JTAG connector, which is compatible with the standard 20-pin connector defined by ARM.

Included Licenses

- J-Link Flashloaders
- J-Link GDB Server
- J-Link Debugger
- J-Flash
- Unlimited Flash Breakpoints
- RDI / RDDI

2.4.5 J-Trace ARM

J-Trace ARM is a JTAG emulator designed for ARM cores which includes trace (ETM) support. It connects via USB to a PC running Microsoft Windows, Apple OSX or Linux. J-Trace has a built-in 20-pin JTAG connector and a built in 38-pin JTAG+Trace connector, which is compatible with the standard 20-pin connector and 38-pin connector defined by ARM.

Included Licenses

- J-Link Flashloaders
- J-Link GDB Server
- J-Link Debugger
- J-Flash
- Unlimited Flash Breakpoints
- RDI / RDDI



2.4.6 J-Trace for Cortex-M



J-Trace for Cortex-M is a JTAG/SWD emulator designed for Cortex-M cores which include trace (ETM) support. J-Trace for Cortex-M can also be used as a regular J-Link.

Included Licenses

J-Link Flashloaders
J-Link GDB Server
J-Link Debugger
J-Flash
Unlimited Flash Breakpoints
RDI / RDDI

Note: In order to use ETM trace on ARM7/9 targets, a J-Trace is needed.

2.4.7 Flasher ARM

Flasher ARM is a programming tool for microcontrollers with on-chip or external Flash memory and ARM core. Flasher ARM is designed for programming flash targets with the J-Flash software or stand-alone. In addition to that Flasher ARM has all of the J-Link functionality. Flasher ARM connects via USB or via RS232 interface to a PC running Microsoft Windows 2000 or later. Flasher ARM has a built-in 20-pin JTAG connector, which is compatible with the standard 20-pin connector defined by ARM.

Licenses

Comes with built-in licenses for flash download and J-Flash.



2.4.8 Flasher RX



Flasher RX is a programming tool for Renesas RX600 series microcontrollers with on-chip or external flash memory and Renesas RX core. Flasher RX is designed for programming flash targets with the J-Flash software or stand-alone. In addition to that Flasher RX has all of the J-Link RX functionality. Flasher RX connects via Ethernet, USB or via RS232 interface to a PC running Microsoft Windows 2000 or later.

Flasher RX itself has a built-in 20-pin JTAG connector but is shipped with an 14-pin adapter for Renesas RX devices.

Licenses

Comes with built-in licenses for flash download and J-Flash.

2.4.9 Flasher PPC

Flasher PPC is a programming tool for PowerPC based microcontrollers with on-chip or external Flash memory. Flasher PPC is designed for programming flash targets with the J-Flash software or stand-alone. In addition to that Flasher PPC has all of the J-Link functionality. Flasher PPC connects via USB or via RS232 interface to a PC running Microsoft Windows 2000 or later. Flasher PPC has a built-in 20-pin JTAG connector, which is compatible with the standard 20-pin connector defined by ARM.

Licenses

Comes with built-in licenses for flash download and J-Flash.



2.5 J-Link OEM versions

There are several different OEM versions of J-Link on the market. The OEM versions look different, but use basically identical hardware. Some of these OEM versions are limited in speed, some can only be used with certain chips and some of these have certain add-on features enabled, which normally requires a license. In any case, it should be possible to use the J-Link software with these OEM versions. However, proper function cannot be guaranteed for OEM versions. SEGGER Microcontroller does not support OEM versions; support is provided by the respective OEM.

2.5.1 Analog Devices: mIDASLink

mIDASLink is an OEM version of J-Link, sold by Analog Devices.

Limitations

mIDASLink works with Analog Devices chips only. This limitation can NOT be lifted; if you would like to use J-Link with a device from an other manufacturer, you need to buy a separate J-Link.

Licenses

Licenses for RDI, J-Link FlashDL and FlashBP are included. Other licenses can be added.



2.5.2 Atmel: SAM-ICE

SAM-ICE is an OEM version of J-Link, sold by Atmel.

Limitations

SAM-ICE works with Atmel devices only. This limitation can NOT be lifted; if you would like to use J-Link with a device from an other manufacturer, you need to buy a separate J-Link.

Licenses

Licenses for RDI and GDB Server are included. Other licenses can be added.



2.5.3 Digi: JTAG Link

Digi JTAG Link is an OEM version of J-Link, sold by Digi International.

Limitations

Digi JTAG Link works with Digi devices only. This limitation can NOT be lifted; if you would like to use J-Link with a device from an other manufacturer, you need to buy a separate J-Link.

Licenses

License for GDB Server is included. Other licenses can be added.



2.5.4 IAR: J-Link / J-Link KS

IAR J-Link / IAR J-Link KS are OEM versions of J-Link, sold by IAR.

Limitations

IAR J-Link / IAR J-Link KS cannot be used with Keil MDK. This limitation can NOT be lifted; if you would like to use J-Link with Keil MDK, you need to buy a separate J-Link. IAR J-Link does not support kickstart power.

Licenses

No licenses are included. All licenses can be added.



2.5.5 IAR: J-Link Lite

IAR J-Link Lite is an OEM version of J-Link, sold by IAR.

Limitations

IAR J-Link Lite cannot be used with Keil MDK. This limitation can NOT be lifted; if you would like to use J-Link with Keil MDK, you need to buy a separate J-Link.

JTAG speed is limited to 4 MHz.

Licenses

No licenses are included. All licenses can be added.

Note: IAR J-Link is only delivered and supported as part of Starter-Kits. It is not sold to end customer directly and not guaranteed to work with custom hardware.



2.5.6 IAR: J-Trace

IAR J-Trace is an OEM version of J-Trace, sold by IAR.

Limitations

IAR J-Trace cannot be used with Keil MDK. This limitation can NOT be lifted; if you would like to use J-Trace with Keil MDK, you need to buy a separate J-Trace.

Licenses

No licenses are included. All licenses can be added.



2.5.7 NXP: J-Link Lite LPC Edition

J-Link Lite LPC Edition is an OEM version of J-Link, sold by NXP.

Limitations

J-Link Lite LPC Edition only works with NXP devices. This limitation can NOT be lifted; if you would like to use J-Link with a device from an other manufacturer, you need to buy a separate J-Link.

Licenses

No licenses are included.



2.5.8 SEGGER: J-Link Lite ARM

J-Link Lite ARM is a fully functional OEM-version of SEGGER J-Link. If you are selling evaluation-boards, J-Link Lite ARM is an inexpensive emulator solution for you. Your customer receives a widely acknowledged JTAG-emulator which allows to start right away with development.

Limitations

JTAG speed is limited to 4 MHz

Licenses

No licenses are included. All licenses can be added.

Note

J-Link Lite ARM is only delivered and supported as part of Starter Kits. It is not sold to end customers and not guaranteed to work with custom hardware.



2.6 J-Link OBs

J-Link OBs (J-Link On Board) are single chip versions of J-Link which are used on various evalboards. It is legal to use J-Link software with these boards.

2.7 Illegal Clones

Clones are copies of SEGGER products which use the copyrighted SEGGER Firmware without a license. It is strictly prohibited to use SEGGER J-Link software with illegal clones of SEGGER products. Manufacturing and selling these clones is an illegal act for various reasons, amongst them trademark, copyright and unfair business practise issues.

The use of illegal J-Link clones with this software is a violation of US, European and other international laws and is prohibited.

If you are in doubt if your unit may be legally used with SEGGER J-Link software, please get in touch with us.

End users may be liable for illegal use of J-Link software with clones.

Chapter 3

J-Link software and documentation package

This chapter describes the contents of the J-Link software and documentation package which can be downloaded from www.segger.com.

3.1 Software overview

The J-Link software and documentation package, which is available for download from <http://www.segger.com/jlink-software.html> includes some applications to be used with J-Link. It also comes with USB-drivers for J-Link and documentations in pdf format.

Software	Description
JLink Commander	Command-line tool with basic functionality for target analysis.
J-Link GDB Server	The J-Link GDB Server is a server connecting to the GNU Debugger (GDB) via TCP/IP. It is required for toolchains using the GDB protocol to connect to J-Link.
J-Link GDB Server command line version	Command line version of the J-Link GDB Server. Same functionality as the GUI version.
J-Link Remote Server	Utility which provides the possibility to use J-Link / J-Trace remotely via TCP/IP.
J-Mem Memory Viewer	Target memory viewer. Shows the memory content of a running target and allows editing as well.
J-Flash ^a	Stand-alone flash programming application. For more information about J-Flash please refer to <i>J-Flash ARM User's Guide (UM08003)</i> .
J-Link RTT Viewer	Free-of-charge utility for J-Link. Displays the terminal output of the target using RTT . Can be used in parallel with a debugger or stand-alone.
J-Link SWO Viewer	Free-of-charge utility for J-Link. Displays the terminal output of the target using the SWO pin. Can be used in parallel with a debugger or stand-alone.
J-Link SWO Analyzer	Command line tool that analyzes SWO RAW output and stores it into a file.
JTAGLoad	Command line tool that opens an <code>svf</code> file and sends the data in it via J-Link / J-Trace to the target.
J-Link Configurator	GUI-based configuration tool for J-Link. Allows configuration of USB identification as well as TCP/IP identification of J-Link. For more information about the J-Link Configurator, please refer to <i>J-Link Configurator</i> on page 177.
RDI support ^a	Provides Remote Debug Interface (RDI) support. This allows the user to use J-Link with any RDI-compliant debugger.
Processor specific tools	Free command-line tools for handling specific processors. Included are: STR9 Commander and STM32 Unlock.

Table 3.1: J-Link / J-Trace related software

a. Full-featured J-Link (PLUS, PRO, ULTRA+) or an additional license for J-Link base model required.

3.2 J-Link Commander (Command line tool)

J-Link Commander (`JLink.exe`) is a tool that can be used for verifying proper installation of the USB driver and to verify the connection to the target CPU, as well as for simple analysis of the target system. It permits some simple commands, such as memory dump, halt, step, go etc. to verify the target connection.

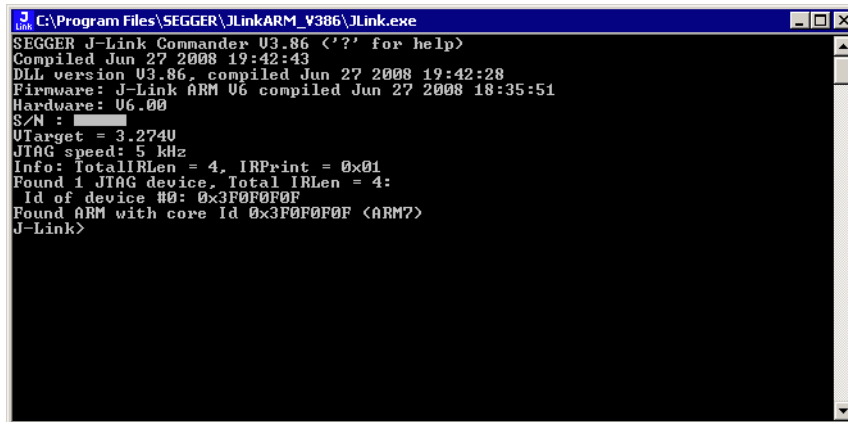

```
C:\Program Files\SEGGER\JLinkARM_V386\JLink.exe
SEGGER J-Link Commander V3.86 '<?' for help>
Compiled Jun 27 2008 19:42:43
DLL version V3.86, compiled Jun 27 2008 19:42:28
Firmware: J-Link ARM V6 compiled Jun 27 2008 18:35:51
Hardware: V6.00
S/N : ████████
UTarget = 3.274U
JTAG speed: 5 kHz
Info: TotalIRLen = 4, IRPrint = 0x01
Found 1 JTAG device, Total IRLen = 4:
  Id of device #0: 0x3F0F0F0F
Found ARM with core Id 0x3F0F0F0F (ARM7)
J-Link>
```

3.2.1 Commands

The table below lists the available commands of J-Link Commander. All commands are listed in alphabetical order within their respective categories. Detailed descriptions of the commands can be found in the sections that follow.

Command (short form)	Explanation
Basic	
<code>clrBP</code>	Clear breakpoint.
<code>clrWP</code>	Clear watchpoint.
<code>device</code>	Selects a device.
<code>erase</code>	Erase internal flash of selected device.
<code>exec</code>	Execute command string.
<code>exit (qc, q)</code>	Closes J-Link Commander.
<code>exitonerror (eoe)</code>	Commander exits after error.
<code>f</code>	Prints firmware info.
<code>go (g)</code>	Starts the CPU core.
<code>halt (h)</code>	Halts the CPU core.
<code>hwinfo</code>	Show hardware info.
<code>is</code>	Scan chain select register length.
<code>loadfile</code>	Load data file into target memory.
<code>log</code>	Enables log to file.
<code>mem</code>	Read memory.
<code>mem8</code>	Read 8-bit items.
<code>mem16</code>	Read 16-bit items.
<code>mem32</code>	Read 32-bit items.
<code>mem64</code>	Read 64-bit items.
<code>mr</code>	Measures reaction time of RTCK pin.
<code>ms</code>	Measures length of scan chain.
<code>power</code>	Switch power supply for target.
<code>r</code>	Resets and halts the target.
<code>readAP</code>	Reads from a CoreSight AP register.
<code>readDP</code>	Reads from a CoreSight DP register.
<code>regs</code>	Shows all current register values.
<code>rnh</code>	Resets without halting the target.
<code>rreg</code>	Shows a specific register value.
<code>rx</code>	Reset target with delay.
<code>savebin</code>	Saves target memory into binary file.
<code>setBP</code>	Set breakpoint.
<code>setPC</code>	Set the PC to specified value.
<code>setWP</code>	Set watchpoint.
<code>sleep</code>	Waits the given time (in milliseconds).
<code>speed</code>	Set target interface speed.
<code>st</code>	Shows the current hardware status.
<code>step (s)</code>	Single step the target chip.
<code>unlock</code>	Unlocks a device.
<code>verifybin</code>	Compares memory with data file.
<code>w1</code>	Write 8-bit items.
<code>w2</code>	Write 16-bit items.
<code>w4</code>	Write 32-bit items.
<code>writeAP</code>	Writes to a CoreSight AP register.
<code>writeDP</code>	Writes to a CoreSight DP register.
<code>wreg</code>	Write register.

Command (short form)	Explanation
Flasher I/O	
<code>fdelete (fdel)</code>	Delete file on emulator.
<code>flist</code>	List directory on emulator.
<code>fread (frd)</code>	Read file from emulator.
<code>fshow</code>	Read and display file from emulator.
<code>fsize (fsz)</code>	Display size of file on emulator.
<code>fwrite (fwr)</code>	Write file to emulator.
Connection	
<code>ip</code>	Connect to J-Link Pro via TCP/IP.
<code>usb</code>	Connect to J-Link via USB.

3.2.1.1 clrBP

This command removes a breakpoint set by J-Link.

Syntax

```
clrBP <BP_Handle>
```

Parameter	Meaning
BP_Handle	Handle of breakpoint to be removed.

Example

```
clrBP 1
```

3.2.1.2 clrWP

This command removes a watchpoint set by J-Link.

Syntax

```
clrWP <WP_Handle>
```

Parameter	Meaning
WP_Handle	Handle of watchpoint to be removed.

Example

```
clrWP 0x2
```

3.2.1.3 device

Selects a specific device J-Link shall connect to and performs a reconnect. In most cases explicit selection of the device is not necessary. Selecting a device enables the user to make use of the J-Link flash programming functionality as well as using unlimited breakpoints in flash memory.

For some devices explicit device selection is mandatory in order to allow the DLL to perform special handling needed by the device.

Some commands require that a device is set prior to use them.

Syntax

```
device <DeviceName>
```

Parameter	Meaning
DeviceName	Valid device name: Device is selected. ?: Shows a device selection dialog.

Example

```
device stm32f407ig
```

3.2.1.4 erase

Erases all flash sectors of the current device. A device has to be specified previously.

Syntax

```
erase
```

3.2.1.5 exec

Execute command string. For more information about the usage of command strings please refer to *Command strings* on page 233.

Syntax

```
exec <Command>
```

Parameter	Meaning
Command	Command string to be executed.

Example

```
exec SupplyPower = 1
```

3.2.1.6 exit (qc, q)

This command closes the target connection, the connection to the J-Link and exits J-Link Commander.

Syntax

```
q
```

3.2.1.7 exitonerror (eoe)

This command toggles whether J-Link Commander exits on error or not.

Syntax

```
ExitOnError <1|0>\
```

Parameter	Meaning
<1 0>	1: J-Link Commander will now exit on Error. 0: J-Link Commander will no longer exit on Error.

Example

```
eoe 1
```

3.2.1.8 f

Prints firmware and hardware version info. Please notice that minor hardware revisions may not be displayed, as they do not have any effect on the feature set.

Syntax

```
f
```

3.2.1.9 fdelete (fdel)

On emulators which support file I/O this command deletes a specific file.

Syntax

```
fdelete <FileName>]
```

Parameter	Meaning
FileName	File to delete from the Flasher.

Example

```
fdelete Flasher.dat
```

3.2.1.10 flist

On emulators which support file I/O this command shows the directory tree of the Flasher.

Syntax

```
flist
```

3.2.1.11 fread (frd)

On emulators which support file I/O this command reads a specific file. Offset applies to both destination and source file.

Syntax

```
fread <EmuFile> <HostFile> [<Offset> [<NumBytes>]]
```

Parameter	Meaning
<code>EmuFile</code>	File name to read from.
<code>HostFile</code>	Destination file on the host.
<code>Offset</code>	Specifies the offset in the file, at which data reading is started.
<code>NumBytes</code>	Maximum number of bytes to read.

Example

```
fread Flasher.dat C:\Project\Flasher.dat
```

3.2.1.12 fshow

On emulators which support file I/O this command reads and prints a specific file. Currently, only Flasher models support file I/O.

Syntax

```
fshow <FileName> [-a] [<Offset> [<NumBytes>]]
```

Parameter	Meaning
<code>FileName</code>	Source file name to read from the Flasher.
<code>a</code>	If set, Input will be parsed as text instead of being shown as hex.
<code>Offset</code>	Specifies the offset in the file, at which data reading is started.
<code>NumBytes</code>	Maximum number of bytes to read.

Example

```
fshow Flasher.dat
```

3.2.1.13 fsize (fsz)

On emulators which support file I/O this command gets the size of a specific file. Currently, only Flasher models support file I/O.

Syntax

```
fsize <FileName>]
```

Parameter	Meaning
<code>FileName</code>	Source file name to read from the Flasher.

Example

```
fsize Flasher.dat
```

3.2.1.14 fwrite (fwr)

On emulators which support file I/O this command writes a specific file. Currently, only Flasher models support file I/O.

NumBytes is limited to 512 bytes at once. This means, if you want to write e.g. 1024 bytes, you have to send the command twice, using an appropriate offset when sending it the second time. Offset applies to both destination and source file.

Syntax

```
fwrite <EmuFile> <HostFile> [<Offset> [<NumBytes>]]
```

Parameter	Meaning
EmuFile	File name to write to.
HostFile	Source file on the host
Offset	Specifies the offset in the file, at which data writing is started.
NumBytes	Maximum number of bytes to write.

Example

```
fwrite Flasher.dat C:\Project\Flasher.dat
```

3.2.1.15 go (g)

Starts the CPU. In order to avoid setting breakpoints it allows to define a maximum number of instructions which can be simulated/emulated. This is particularly useful when the program is located in flash and flash breakpoints are used. Simulating instructions avoids to reprogram the flash and speeds up (single) stepping.

Syntax

```
go [<NumSteps> [<Flags>]]
```

Parameter	Meaning
NumSteps	Maximum number of instructions allowed to be simulated. Instruction simulation stops whenever a breakpointed instruction is hit, an instruction which cannot be simulated/emulated is hit or when NumSteps is reached.
Flags	0: Do not start the CPU if a BP is in range of NumSteps 1: Overstep BPs

Example

```
go //Simply starts the CPU
```

```
go 20, 1
```

3.2.1.16 halt (h)

Halts the CPU Core. If successful, shows the current CPU registers.

Syntax

```
halt
```

3.2.1.17 hwinfo

This command can be used to get information about the power consumption of the target (if the target is powered via J-Link). It also gives the information if an over-current happened.

Syntax

```
hwinfo
```

3.2.1.18 ip

Closes any existing connection to J-Link and opens a new one via TCP/IP.
If no IP Address is specified, the Emulator selection dialog shows up.

Syntax

```
ip [<Addr>]
```

Parameter	Meaning
Addr	Valid values: IP Address: Connects the J-Link with the specified IP-Address Host Name: Resolves the host name and connects to it. *: Invokes the Emulator selection dialog.

Example

```
ip 192.168.6.3
```

3.2.1.19 is

This command returns information about the length of the scan chain select register.

Syntax

```
is
```

3.2.1.20 loadfile

This command programs a given data file to a specified destination address.
Currently supported data files are:

- *.mot
- *.srec
- *.s19
- *.s
- *.hex
- *.bin

Syntax

```
loadfile <Filename> [<Addr>]
```

Parameter	Meaning
Filename	Source filename
Addr	Destination address (Required for *.bin files)

Example

```
loadfile C:\Work\test.bin 0x20000000
```

3.2.1.21 log

Set path to logfile allowing the DLL to output logging information.
If the logfile already exist, the contents of the current logfile will be overwritten.

Syntax

```
log <Filename>
```

Parameter	Meaning
Filename	Log filename

Example

```
log C:\Work\log.txt
```

3.2.1.22 mem

The command reads memory from the target system. If necessary, the target CPU is halted in order to read memory.

Syntax

```
mem [<Zone>:]<Addr>, <NumBytes> (hex)
```

Parameter	Meaning
Zone	Name of memory zone to access.
Addr	Start address.
Numbytes	Number of bytes to read. Maximum is 0x100000.

Example

```
mem 0, 100
```

3.2.1.23 mem8

The command reads memory from the target system in units of bytes. If necessary, the target CPU is halted in order to read memory.

Syntax

```
mem8 [<Zone>:]<Addr>, <NumBytes> (hex)
```

Parameter	Meaning
Zone	Name of memory zone to access.
Addr	Start address.
NumBytes	Number of bytes to read. Maximum is 0x10000.

Example

```
mem8 0, 100
```

3.2.1.24 mem16

The command reads memory from the target system in units of 16-bits. If necessary, the target CPU is halted in order to read memory.

Syntax

```
mem16 [<Zone>:]<Addr>, <NumBytes> (hex)
```

Parameter	Meaning
Zone	Name of memory zone to access.
Addr	Start address.
NumBytes	Number of bytes to read. Maximum is 0x8000.

Example

```
mem16 0, 100
```

3.2.1.25 mem32

The command reads memory from the target system in units of 32-bits. If necessary, the target CPU is halted in order to read memory.

Syntax

```
mem32 [<Zone>:]<Addr>, <NumBytes> (hex)
```

Parameter	Meaning
Zone	Name of memory zone to access.
Addr	Start address.
NumBytes	Number of bytes to read. Maximum is 0x4000.

Example

```
mem32 0, 100
```

3.2.1.26 mem64

The command reads memory from the target system in units of 64-bits. If necessary, the target CPU is halted in order to read memory.

Syntax

```
mem64 [<Zone>:]<Addr>, <NumBytes> (hex)
```

Parameter	Meaning
Zone	Name of memory zone to access.
Addr	Start address.
NumBytes	Number of bytes to read. Maximum is 0x4000.

Example

```
mem64 0, 100
```

3.2.1.27 mr

Measure reaction time of RTCK pin.

Syntax

```
mr [<RepCount>]
```

Parameter	Meaning
RepCount	Number of times the test is repeated (Default: 1).

Example

```
mr 3
```

3.2.1.28 ms

Measures the number of bits in the specified scan chain.

Syntax

```
ms <ScanChain>
```

Parameter	Meaning
ScanChain	Scan chain to be measured.

Example

```
ms 1
```

3.2.1.29 power

This command sets the status of the power supply over pin 19 of the JTAG connector. The KS(Kickstart) versions of J-Link have the 5V supply over pin 19 activated by default. This feature is useful for some targets that can be powered over the JTAG connector.

Syntax

```
power <State> [perm]
```

Parameter	Meaning
State	Valid values: On, Off
perm	Sets the specified State value as default.

Example

```
f
```

3.2.1.30 r

Resets and halts the target.

Syntax

```
r
```

3.2.1.31 readAP

Reads from a CoreSight AP register.

This command performs a full-qualified read which means that it tries to read until the read has been accepted or too many WAIT responses have been received. In case actual read data is returned on the next read request (this is the case for example with interface JTAG) this command performs the additional dummy read request automatically.

Syntax

```
ReadAP <RegIndex>
```

Parameter	Meaning
RegIndex	Index of AP register to read

Example

```
//
// Read AP[0], IDR (register 3, bank 15)
//
WriteDP 2, 0x000000F0 // Select AP[0] bank 15
ReadAP 3             // Read AP[0] IDR
```

3.2.1.32 readDP

Reads from a CoreSight DP register.

This command performs a full-qualified read which means that it tries to read until the read has been accepted or too many WAIT responses have been received. In case actual read data is returned on the next read request (this is the case for example with interface JTAG) this command performs the additional dummy read request automatically.

Syntax

```
ReadDP <RegIndex>
```

Parameter	Meaning
RegIndex	Index of DP register to read

Example

```
//
// Read DP-CtrlStat
//
ReadDP 1
```

3.2.1.33 regs

Shows all current register values.

Syntax

```
regs
```

3.2.1.34 rnh

This command performs a reset but without halting the device.

Syntax

```
rnh
```

3.2.1.35 rreg

The function prints the value of the specified CPU register.

Syntax

```
rreg <RegIndex>
```

Parameter	Meaning
RegIndex	Register to read.

Example

```
rreg 15
```

3.2.1.36 rx

Resets and halts the target. It is possible to define a delay in milliseconds after reset. This function is useful for some target devices which already contain an application or a boot loader and therefore need some time before the core is stopped, for example to initialize hardware, the memory management unit (MMU) or the external bus interface.

Syntax

```
rx <DelayAfterReset>
```

Parameter	Meaning
DelayAfter-Reset	Delay in ms.

Example

```
rx 10
```

3.2.1.37 savebin

Saves target memory into binary file.

Syntax

```
savebin <Filename>, <Addr>, <NumBytes> (hex)
```

Parameter	Meaning
Filename	Destination file
Addr	Source address.
NumBytes	Number of bytes to read.

Example

```
savebin C:\Work\test.bin 0x0000000 0x100
```

3.2.1.38 setBP

This command sets a breakpoint of a specific type at a specified address. Which breakpoint modes are available depends on the CPU that is used.

Syntax

```
setBP <Addr> [[A/T]/[W/H]] [S/H]
```

Parameter	Meaning
Addr	Address to be breakpointed.
A/T	Only for ARM7/9/11 and Cortex-R4 devices: A: ARM mode T: THUMB mode
W/H	Only for MIPS devices: W: MIPS32 mode (Word) H: MIPS16 mode (Half-word)
S/H	S: Force software BP H: Force hardware BP

Example

```
setBP 0x8000036
```

3.2.1.39 setPC

Sets the PC to the specified value.

Syntax

```
setpc <Addr>
```

Parameter	Meaning
Addr	Address the PC should be set to.

Example

```
setpc 0x59C
```

3.2.1.40 setWP

This command inserts a new watchpoint that matches the specified parameters. The enable bit for the watchpoint as well as the data access bit of the watchpoint unit are set automatically by this command. Moreover the bits DBGEXT, CHAIN and the

RANGE bit (used to connect one watchpoint with the other one) are automatically masked out. In order to use these bits you have to set the watchpoint by writing the ICE registers directly.

Syntax

```
setWP <Addr> [<AccessType>] [<Size>] [<Data> [<DataMask> [<AddrMask>]]]
```

Parameter	Meaning
Addr	Address to be watchpointed.
Accesstype	Specifies the control data on which data event has been set: R: read access W: write access
Size	Valid values: S8 S16 S32 Specifies to monitor an n-bit access width at the selected address.
Data	Specifies the Data on which watchpoint has been set.
DataMask	Specifies data mask used for comparison. Bits set to 1 are masked out, so not taken into consideration during data comparison. Please note that for certain cores not all Bit-Mask combinations are supported by the core-debug logic. On some cores only complete bytes can be masked out (e.g. PIC32) or similar.
AddrMask	Specifies the address mask used for comparison. Bits set to 1 are masked out, so not taken into consideration during address comparison. Please note that for certain cores not all Bit-Mask combinations are supported by the core-debug logic. On some cores only complete bytes can be masked out (e.g. PIC32) or similar.

Example

```
setWP 0x20000000 W S8 0xFF
```

3.2.1.41 sleep

Waits the given time (in milliseconds).

Syntax

```
sleep <Delay>
```

Parameter	Meaning
Delay	Amount of time to sleep in ms.

Example

```
sleep 200
```

3.2.1.42 speed

This command sets the speed for communication with the CPU core.

Syntax

```
speed <Freq>|auto|adaptive
```

Parameter	Meaning
Freq	Specifies the interface frequency in kHz.
auto	Selects auto detection of JTAG speed.
adaptive	Selects adaptive clocking as JTAG speed.

Example

```
speed 4000
speed auto
```

3.2.1.43 st

This command prints the current hardware status. Prints the current status of TCK, TDI, TDO, TMS, TRES, TRST and the interface speeds supported by the target. Also shows the Target Voltage.

Syntax

```
st
```

3.2.1.44 step (s)

Target needs to be halted before calling this command. Executes a single step on the target. The instruction is overstepped even if it is breakpointed. Prints out the disassembly of the instruction to be stepped.

Syntax

```
step
```

3.2.1.45 unlock

This command unlocks a device which has been accidentally locked by malfunction of user software.

Syntax

```
unlock <DeviceName>
```

Parameter	Meaning
DeviceName	Name of the device family to unlock. Supported Devices: LM3Sxxx Kinetis EFM32Gxxx

Example

```
unlock Kinetis
```

3.2.1.46 usb

Closes any existing connection to J-Link and opens a new one via USB. It is possible to select a specific J-Link by port number.

Syntax

```
usb [<Port>]
```

Parameter	Meaning
Port	Valid values: 0..3

Example

```
usb
```

3.2.1.47 verifybin

Verifies if the specified binary is already in the target memory at the specified address.

Syntax

```
verifybin <Filename>, <Addr>
```

Parameter	Meaning
Filename	Sample bin.
Addr	Start address of memory to verify.

Example

```
verifybin C:\Work\test.bin 0x0000000
```

3.2.1.48 w1

The command writes one single byte to the target system.

Syntax

```
w1 [<Zone>:]<Addr>, <Data> (hex)
```

Parameter	Meaning
Zone	Name of memory zone to access.
Addr	Start address.
Data	8-bits of data to write.

Example

```
w1 0x10, 0xFF
```

3.2.1.49 w2

The command writes a unit of 16-bits to the target system.

Syntax

```
w2 [<Zone>:]<Addr>, <Data> (hex)
```

Parameter	Meaning
Zone	Name of memory zone to access.
Addr	Start address.
Data	16-bits of data to write.

Example

```
w2 0x0, 0xFFFF
```

3.2.1.50 w4

The command writes a unit of 32-bits to the target system.

Syntax

```
w4 [<Zone>:]<Addr>, <Data> (hex)
```

Parameter	Meaning
Zone	Name of memory zone to access.
Addr	Start address.
Data	32-bits of data to write.

Example

```
w4 0x0, 0xAABBCCFF
```

3.2.1.51 writeAP

Writes to a CoreSight AP register.

This command performs a full-qualified write which means that it tries to write until the write has been accepted or too many WAIT responses have been received.

Syntax

```
WriteAP <RegIndex>, <Data32Hex>
```

Parameter	Meaning
RegIndex	Index of AP register to write
Data32Hex	Data to write

Example

```
//
// Select AHB-AP and configure it
//
WriteDP 2, 0x00000000 // Select AP[0] (AHB-AP) bank 0
WriteAP 4, 0x23000010 // Auto-increment, Private access, Access size: word
```

3.2.1.52 writeDP

Writes to a CoreSight DP register.

This command performs a full-qualified write which means that it tries to write until the write has been accepted or too many WAIT responses have been received.

Syntax

```
WriteDP <RegIndex>, <Data32Hex>
```

Parameter	Meaning
RegIndex	Index of DP register to write
Data32Hex	Data to write

Example

```
//
// Write DP SELECT register: Select AP 0 bank 15
//
WriteDP 2, 0x000000F0
```

3.2.1.53 wreg

Writes into a register. The value is written into the register on CPU start.

Syntax

```
wreg <RegName>, <Data>
```

Parameter	Meaning
RegName	Register to write to.
Data	Data to write to the specified register.

Example

```
wreg R14, 0xFF
```

3.2.2 Command line options

J-Link Commander can be started with different command line options for test and automation purposes. In the following, the command line options which are available for J-Link Commander are explained. All command line options are case insensitive.

Command	Explanation
<code>-AutoConnect</code>	Automatically start the target connect sequence
<code>-CommanderScript</code>	Passes a <code>CommandFile</code> to J-Link
<code>-CommandFile</code>	Passes a <code>CommandFile</code> to J-Link
<code>-Device</code>	Pre-selects the device J-Link Commander shall connect to
<code>-ExitOnError</code>	Commander exits after error.
<code>-If</code>	Pre-selects the target interface
<code>-IP</code>	Selects IP as host interface
<code>-JLinkScriptFile</code>	Passes a <code>JLinkScriptFile</code> to J-Link
<code>-JTAGConf</code>	Sets IRPre and DRPre
<code>-RTTtelnetPort</code>	Sets the RTT Telnetport
<code>-SelectEmuBySN</code>	Connects to a J-Link with a specific S/N over USB
<code>-SettingsFile</code>	Passes a <code>SettingsFile</code> to J-Link
<code>-Speed</code>	Starts J-Link Commander with a given initial speed

Table 3.2: Available command line options

3.2.2.1 -AutoConnect

This command can be used to let J-Link Commander automatically start the connect sequence for connecting to the target when entering interactive mode.

Syntax

```
-autoconnect <1|0>
```

Example

```
JLink.exe -autoconnect 1
```

3.2.2.2 -CommanderScript

Similar to `-CommandFile`

3.2.2.3 -CommandFile

Selects a command file and starts J-Link Commander in batch mode. The batch mode of J-Link Commander is similar to the execution of a batch file. The command file is parsed line by line and one command is executed at a time.

Syntax

```
-CommandFile <CommandFilePath>
```

Example

See *Using command files* on page 103

3.2.2.4 -Device

Pre-selects the device J-Link Commander shall connect to. For some devices, J-Link already needs to know the device at the time of connecting, since special handling is required for some of them. For a list of all supported device names, please refer to http://www.segger.com/jlink_supported_devices.html.

Syntax

```
-Device <DeviceName>
```

Example

```
JLink.exe -Device STM32F103ZE
```

3.2.2.5 -ExitOnError

Similar to the `exitonerror (eoe)` command.

3.2.2.6 -If

Selects the target interface J-Link shall use to connect to the target. By default, J-Link Commander first tries to connect to the target using the target interface which is currently selected in the J-Link firmware. If connecting fails, J-Link Commander goes through all target interfaces supported by the connected J-Link and tries to connect to the device.

Syntax

```
-If <TargetInterface>
```

Example

```
JLink.exe -If SWD
```

Additional information

Currently, the following target interfaces are supported:

- JTAG
- SWD

3.2.2.7 -IP

Selects IP as host interface to connect to J-Link. Default host interface is USB.

Syntax

```
-IP <IPAddr>
```

Example

```
JLink.exe -IP 192.168.1.17
```

Additional information

To select from a list of all available emulators on Ethernet, please use `*` as `<IPAddr>`.

3.2.2.8 -JLinkScriptFile

Passes the path of a J-Link script file to the J-Link Commander. J-Link scriptfiles are mainly used to connect to targets which need a special connection sequence before communication with the core is possible. For more information about J-Link script files, please refer to *J-Link script files* on page 216.

Syntax

```
JLink.exe -JLinkScriptFile <File>
```

Example

```
JLink.exe -JLinkScriptFile "C:\My Projects\Default.JLinkScript"
```

3.2.2.9 -JTAGConf

Passes IRPre and DRPre in order to select a specific device in a JTAG-chain. "-1,-1" can be used to let J-Link select a device automatically.

Syntax

```
-JTAGConf <IRPre>,<DRPre>
```

Example

```
JLink.exe -JTAGConf 4,1  
JLink.exe -JTAGConf -1,-1
```

3.2.2.10 -SelectEmuBySN

Connect to a J-Link with a specific serial number via USB. Useful if multiple J-Links are connected to the same PC and multiple instances of J-Link Commander shall run and each connects to another J-Link.

Syntax

```
-SelectEmuBySN <SerialNo>
```

Example

```
JLink.exe -SelectEmuBySN 580011111
```

3.2.2.11 -RTTTelnetPort

This command alters the RTT telnet port. Default is 19021.

Syntax

```
-RTTTelnetPort <Port>
```

Example

```
JLink.exe -RTTTelnetPort 9100
```

3.2.2.12 -SettingsFile

Select a J-Link settings file to be used for the target device. The settings file can contain all configurable options of the Settings tab in J-Link Control panel.

Syntax

```
-SettingsFile <PathToFile>
```

Example

```
JLink.exe -SettingsFile "C:\Work\settings.txt"
```

3.2.2.13 -Speed

Starts J-Link Commander with a given initial speed. Available parameters are "adaptive", "auto" or a freely selectable integer value in kHz. It is recommended to use either a fixed speed or, if it is available on the target, adaptive speeds. Default interface speed is 100kHz.

Syntax

```
-Speed <Speed_kHz>
```

Example

```
JLink.exe -Speed 4000
```

3.2.3 Using command files

J-Link commander can also be used in batch mode which allows the user to use J-Link commander for batch processing and without user interaction. Please do not confuse command file with J-Link script files (please refer to *J-Link script files* on page 216 for more information about J-Link script files). When using J-Link commander in batch mode, the path to a command file is passed to it. The syntax in the command file is the same as when using regular commands in J-Link commander (one line per command). SEGGER recommends to always pass the device name via command line option due some devices need special handling on connect/reset in order to guarantee proper function.

Example

```
JLink.exe -device STM32F103ZE -CommanderScript C:\CommandFile.jlink
```

Contents of CommandFile.jlink:

```
si 1
speed 4000
r
h
loadbin C:\firmware.bin,0x08000000
```

3.3 J-Link GDB Server

The GNU Project Debugger (GDB) is a freely available and open source debugger. It can be used in command line mode, but is also integrated in many IDEs like emIDE or Eclipse.

J-Link GDB Server is a remote server for GDB making it possible for GDB to connect to and communicate with the target device via J-Link. GDB Server and GDB communicate via a TCP/IP connection, using the standard GDB remote protocol. GDB Server receives the GDB commands, does the J-Link communication and replies with the answer to GDB.

With J-Link GDB Server debugging in ROM and Flash of the target device is possible and the Unlimited Flash Breakpoints can be used.

It also comes with some functionality not directly implemented in the GDB. These can be accessed via monitor commands, sent directly via GDB, too.

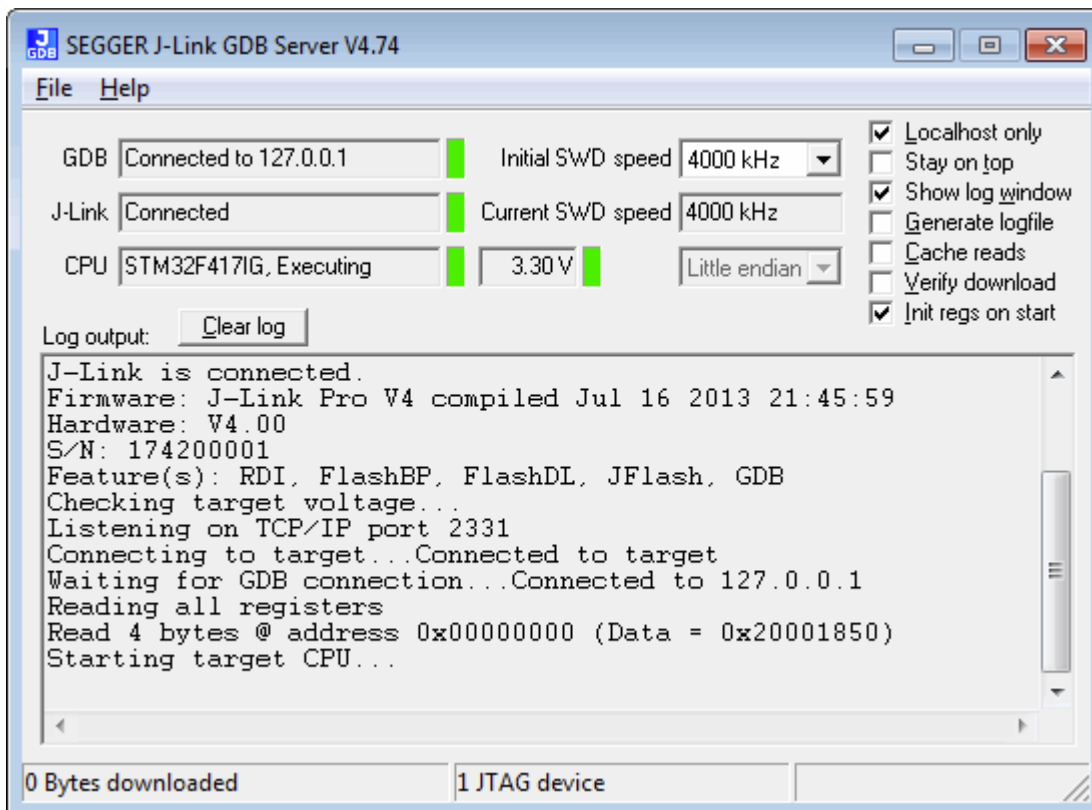

The GNU Project Debugger (GDB) is a freely available debugger, distributed under the terms of the GPL. The latest Unix version of the GDB is freely available from the GNU committee under: <http://www.gnu.org/software/gdb/download/>

J-Link GDB Server is distributed free of charge.

3.3.1 J-Link GDB Server CL (Windows, Linux, Mac)

J-Link GDB Server CL is a commandline-only version of the GDB Server. The command line version is part of the Software and Documentation Package and also included in the Linux and MAC versions.

Except for the missing GUI, J-Link GDB Server CL is identical to the normal version. All sub-chapters apply to the command line version, too.

3.3.2 Debugging with J-Link GDB Server

With J-Link GDB Server programs can be debugged via GDB directly on the target device like a normal application. The application can be loaded into RAM or flash of the device.

Before starting GDB Server make sure a J-Link and the target device are connected.

3.3.2.1 Setting up GDB Server GUI version

The GUI version of GDB Server is part of the Windows J-Link Software Package (JLinkGDBServer.exe).

When starting GDB Server a configuration dialog pops up letting you select the needed configurations to connect to J-Link and the target.

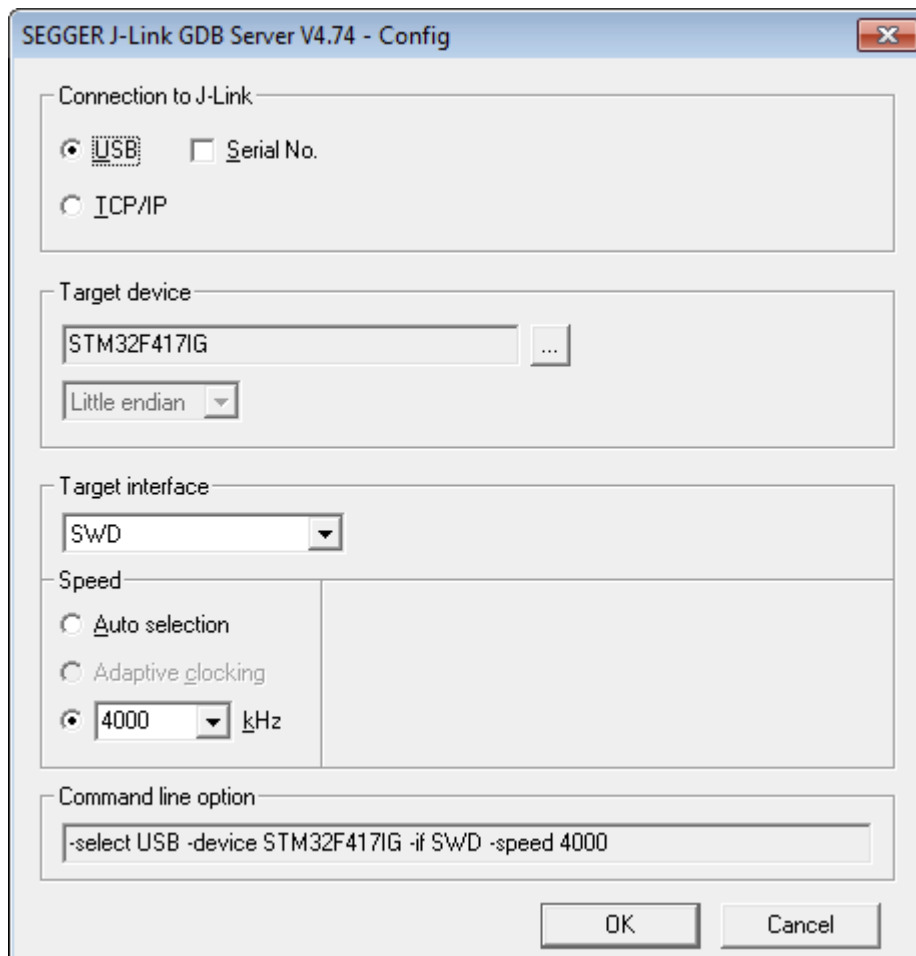

All configurations can optionally be given in the command line options.

Note: To make sure the connection to the target device can be established correctly, the device, as well as the interface and interface speed have to be given on start of GDB Server, either via command line options or the configuration dialog. If the target device option (`-device`) is given, the configuration dialog will not pop up.

3.3.2.2 Setting up GDB Server CL version

The command line version of GDB Server is part of the J-Link Software Package for all supported platforms.

On Windows its name is JLinkGDBServerCL.exe, on Linux and Mac it is JLinkGDB-Server.

Starting GDB Server on Windows

To start GDB Server CL on Windows, open the 'Run' prompt (Windows-R) or a command terminal (cmd) and enter `<PathToJLinkSoftware>\JLinkGDBServerCL.exe <CommandLineOptions>`.

Starting GDB Server on Linux / Mac

To start GDB Server CL on Linux / Mac, open a terminal and call `JLinkGDBServer <CommandLineOptions>`

Command Line Options

When using GDB Server CL, at least the mandatory command line options have to be given. Additional command line options can be given to change the default behavior of GDB Server.

For more information about the available command line options, please refer to *Command line options* on page 125.

3.3.2.3 GDB Server user interface

The J-Link GDB Server's user interface shows information about the debugging process and the target and allows to configure some settings during execution.

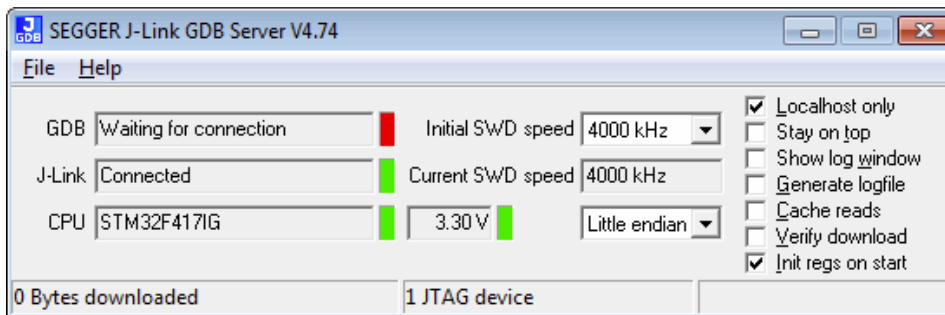

It shows following information:

- The IP address of host running debugger.
- Connection status of J-Link.
- Information about the target core.
- Measured target voltage.
- Bytes that have been downloaded.
- Status of target.
- Log output of the GDB Server (optional, if Show log window is checked).
- Initial and current target interface speed.
- Target endianness.

These configurations can be made from inside GDB Server:

- Localhost only: If checked only connections from 127.0.0.1 are accepted.
- Stay on top
- Show log window.
- Generate logfile: If checked, a log file with the GDB <-> GDB Server <-> J-Link communication will be created.
- Verify download: If checked, the memory on the target will be verified after download.
- Init regs on start: If checked, the register values of the target will be set to a reasonable value before on start of GDB Server.

3.3.2.4 Running GDB from different programs

We assume that you already have a solid knowledge of the software tools used for building your application (assembler, linker, C compiler) and especially the debugger and the debugger frontend of your choice. We do not answer questions about how to install and use the chosen toolchain.

GDB is included in many IDEs and most commonly used in connection with the GCC compiler toolchain. This chapter shows how to configure some programs to use GDB and connect to GDB Server. For more information about any program using GDB, please refer to its user manual.

emIDE

emIDE is a full-featured, free and open source IDE for embedded development including support for debugging with J-Link.

To connect to GDB Server with emIDE, the GDB Server configurations need to be set in the project options at Project -> Properties... -> Debugger.

Select the target device you are using, the target connection, endianness and speed and enter the additional GDB start commands.

The typically required GDB commands are:

```
#Initially reset the target
monitor reset
#Load the application
load
```

Other commands to set up the target (e.g. Set PC to RAM, initialize external flashes) can be entered here, too.

emIDE will automatically start GDB Server on start of the debug session. If it does not, or an older version of GDB Server starts, in emIDE click on JLink -> Run the JLink-plugin configuration.

The screenshot below shows a debug session in IDE. For download and more information about emIDE, please refer to <http://emide.org>.

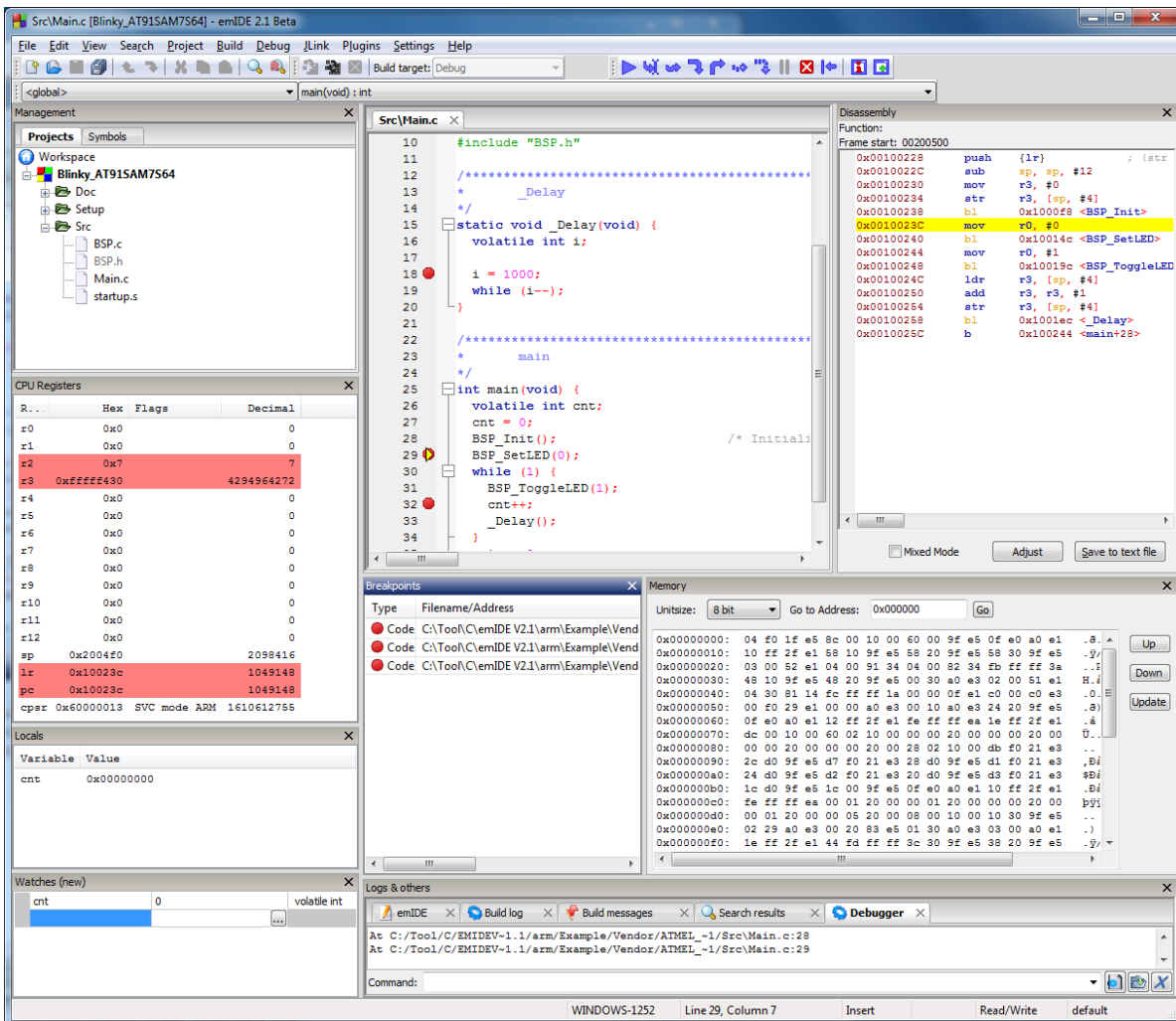

Console

GDB can be used stand-alone as a console application.

To connect GDB to GDB Server enter `target remote localhost:2331` into the running GDB. Within GDB all GDB commands and the remote monitor commands are available. For more information about debugging with GDB refer to its online manual available at <http://sourceware.org/gdb/current/onlinedocs/gdb/>.

A typical startup of a debugging session can be like:

```

(gdb) file C:/temp/Blinky.elf
Reading symbols from C:/temp/Blinky.elf...done.
(gdb) target remote localhost:2331
Remote debugging using localhost:2331
0x00000000 in ?? ()
(gdb) monitor reset
Resetting target
(gdb) load
Loading section .isr_vector, size 0x188 lma 0x8000000
Loading section .text, size 0x568 lma 0x8000188
Loading section .init_array, size 0x8 lma 0x80006f0
Loading section .fini_array, size 0x4 lma 0x80006f8
Loading section .data, size 0x428 lma 0x80006fc
Start address 0x8000485, load size 2852
Transfer rate: 146 KB/sec, 570 bytes/write.
(gdb) break main
Breakpoint 1 at 0x800037a: file Src/main.c, line 38.
(gdb) continue
Continuing.

Breakpoint 1, main () at Src/main.c:38
38      Cnt = 0;
(gdb)

```

Eclipse (CDT)

Eclipse is an open source platform-independent software framework, which has typically been used to develop integrated development environment (IDE). Therefore Eclipse can be used as C/C++ IDE, if you extend it with the CDT plug-in (<http://www.eclipse.org/cdt/>).

CDT means "C/C++ Development Tooling" project and is designed to use the GDB as default debugger and works without any problems with the GDB Server.

Refer to <http://www.eclipse.org> for detailed information about Eclipse.

Note: We only support problems directly related to the GDB Server. Problems and questions related to your remaining toolchain have to be solved on your own.

3.3.3 Supported remote (monitor) commands

J-Link GDB Server comes with some functionalities which are not part of the standard GDB. These functions can be called either via a gdbinit file passed to GDB Server or via monitor commands passed directly to GDB, forwarding them to GDB Server.

To indicate to GDB to forward the command to GDB Server 'monitor' has to be prepended to the call. For example a reset can be triggered in the gdbinit file with "reset" or via GDB with "monitor reset".

Following remote commands are available:

Remote command	Explanation
<code>clrbp</code>	Removes an instruction breakpoint.
<code>cp15</code>	Reads or writes from/to cp15 register.
<code>device</code>	Select the specified target device.
<code>DisableChecks</code>	Do not check if an abort occurred after memory read (ARM7/9 only).
<code>EnableChecks</code>	Check if an abort occurred after memory read (ARM7/9 only).
<code>flash breakpoints</code>	Enables/Disables flash breakpoints.
<code>getargs</code>	Get the arguments for the application.
<code>go</code>	Starts the target CPU.
<code>halt</code>	Halts the target CPU.
<code>jtagconf</code>	Configures a JTAG scan chain with multiple devices on it.
<code>memU8</code>	Reads or writes a byte from/to given address.
<code>memU16</code>	Reads or writes a halfword from/to given address.
<code>memU32</code>	Reads or writes a word from/to given address.
<code>reg</code>	Reads or writes from/to given register.
<code>regs</code>	Reads and displays all CPU registers.
<code>reset</code>	Resets and halts the target CPU.
<code>semihosting breakOn-Error</code>	Enable or disable halting the target on semihosting error.
<code>semihosting enable</code>	Enables semihosting.
<code>semihosting IOClient</code>	Set semihosting I/O to be handled via Telnet port or GDB.
<code>semihosting ARMSWI</code>	Sets the SWI number used for semihosting in ARM mode.
<code>semihosting ThumbSWI</code>	Sets the SWI number used for semihosting in thumb mode.
<code>setargs</code>	Set the arguments for the application.
<code>setbp</code>	Sets an instruction breakpoint at a given address.
<code>sleep</code>	Sleeps for a given time period.
<code>speed</code>	Sets the JTAG speed of J-Link / J-Trace.
<code>step</code>	Performs one or more single instruction steps.
<code>SWO DisableTarget</code>	Undo target configuration for SWO and disable it in J-Link.
<code>SWO EnableTarget</code>	Configure target for SWO and enable it in J-Link.
<code>SWO GetMaxSpeed</code>	Prints the maximum supported SWO speed for J-Link and Target CPU.
<code>SWO GetSpeedInfo</code>	Prints the available SWO speed and its minimum divider.
<code>waithalt</code>	Waits for target to halt code execution.
<code>wice</code>	Writes to given IceBreaker register.

Table 3.3: GDB remote commands

Following remote commands are deprecated and only available for backward compatibility:

Remote command	Explanation
<code>device</code>	Select the specified target device. Note: Use command line option <code>-device</code> instead.
<code>interface</code>	Select the target interface. Note: Use command line option <code>-if</code> instead.
<code>speed</code>	Sets the JTAG speed of J-Link / J-Trace. Note: For the initial connection speed, use command line option <code>-speed</code> instead.

Table 3.4: GDB remote commands

Note: The remote commands are case-insensitive.

Note: Optional parameters are set into square brackets.

Note: The examples are described as follows:

Lines starting with '#' are comments and not used in GDB / GDB Server.

Lines starting with '>' are input commands from the GDB.

Lines starting with '<' is the output from GDB Server as printed in GDB.

3.3.3.1 clrbp

Syntax

```
ClrBP [<BPHandle>]
```

or

```
ci [<BPHandle>]
```

Description

Removes an instruction breakpoint, where <BPHandle> is the handle of breakpoint to be removed. If no handle is specified this command removes all pending breakpoints.

Example

```
> monitor clrbp 1
```

or

```
> monitor ci 1
```

3.3.3.2 cp15

Syntax

```
cp15 <CRn>, <CRm>, <op1>, <op2> [= <data>]
```

Description

Reads or writes from/to cp15 register. If <data> is specified, this command writes the data to the cp15 register. Otherwise this command reads from the cp15 register. For further information please refer to the ARM reference manual.

Example

```
#Read:
> monitor cp15 1, 2, 6, 7
< Reading CP15 register (1,2,6,7 = 0x0460B77D)

#Write:
> monitor cp15 1, 2, 6, 7 = 0xFFFFFFFF
```

3.3.3.3 device

Note: Deprecated. Use command line option `-device` instead.

Syntax

```
device <DeviceName>
```

Description

Selects the specified target device. This is necessary for the connection and some special handling of the device.

Note: The device should be selected via commandline option `-device` when starting GDB Server.

Example

```
> monitor device STM32F417IG
< Selecting device: STM32F417IG
```

3.3.3.4 DisableChecks

Syntax

```
DisableChecks
```

Description

Disables checking if a memory read caused an abort (ARM7/9 devices only). On some CPUs during the init sequence for enabling access to the internal memory (for example on the TMS470) some dummy reads of memory are required which will cause an abort as long as the access-init is not completed.

3.3.3.5 EnableChecks

Syntax

```
EnableChecks
```

Description

Enables checking if a memory read caused an abort (ARM7/9 devices only). On some CPUs during the init sequence for enabling access to the internal memory (for example on the TMS470) some dummy reads of memory are required which will cause an abort as long as the access-init is not completed. The default state is: Checks enabled.

3.3.3.6 flash breakpoints

Syntax

```
monitor flash breakpoints = <Value>
```

Description

This command enables/disables the Flash Breakpoints feature.

By default Flash Breakpoints are enabled and can be used for evaluation.

Example

```
#Disable Flash Breakpoints:
> monitor flash breakpoints = 0
< Flash breakpoints disabled

#Enable Flash Breakpoints:
> monitor flash breakpoints = 1
< Flash breakpoints enabled
```

3.3.3.7 getargs

Syntax

```
getargs
```

Description

Get the currently set argument list which will be given to the application when calling semihosting command SYS_GET_CMDLINE (0x15). The argument list is given as one string.

Example

```
#No arguments set via setargs:
> monitor getargs
< No arguments.
#Arguments set via setargs:
> monitor getargs
< Arguments: test 0 1 2 arg0=4
```

3.3.3.8 go

Syntax

```
go
```

Description

Starts the target CPU.

Example

```
> monitor go
```

3.3.3.9 halt**Syntax**

```
halt
```

Description

Halts the target CPU.

Example

```
> monitor halt
```

3.3.3.10 interface

Note: Deprecated. Use command line option `-if` instead.

Syntax

```
interface <InterfaceIdentifier>
```

Description

Selects the target interface used by J-Link / J-Trace.

3.3.3.11 jtagconf**Syntax**

```
jtagconf <IRPre> <DRPre>
```

Description

Configures a JTAG scan chain with multiple devices on it. `<IRPre>` is the sum of IRLens of all devices closer to TDI, where IRLen is the number of bits in the IR (Instruction Register) of one device. `<DRPre>` is the number of devices closer to TDI. For more detailed information of how to configure a scan chain with multiple devices please refer to See "Determining values for scan chain configuration" on page 193..

Note: To make sure the connection to the device can be established correctly, it is recommended to configure the JTAG scan chain via command line options at the start of GDB Server.

Example

```
#Select the second device, where there is 1 device in front with IRLen 4
> monitor jtagconf 4 1
```

3.3.3.12 memU8**Syntax**

```
MemU8 <address> [= <value>]
```

Description

Reads or writes a byte from/to a given address. If `<value>` is specified, this command writes the value to the given address. Otherwise this command reads from the given address.

Example

```
#Read:
> monitor memU8 0x50000000
< Reading from address 0x50000000 (Data = 0x04)

#Write:
> monitor memU8 0x50000000 = 0xFF
< Writing 0xFF @ address 0x50000000
```

3.3.3.13 memU16

Syntax

```
memU16 <address> [= <value>]
```

Description

Reads or writes a halfword from/to a given address. If <value> is specified, this command writes the value to the given address. Otherwise this command reads from the given address.

Example

```
#Read:
> monitor memU16 0x50000000
< Reading from address 0x50000000 (Data = 0x3004)

#Write:
> monitor memU16 0x50000000 = 0xFF00
< Writing 0xFF00 @ address 0x50000000
```

3.3.3.14 memU32

Syntax

```
MemU32 <address> [= <value>]
```

Description

Reads or writes a word from/to a given address. If <value> is specified, this command writes the value to the given address. Otherwise this command reads from the given address. This command is similar to the long command.

Example

```
#Read:
> monitor memU32 0x50000000
< Reading from address 0x50000000 (Data = 0x10023004)

#Write:
> monitor memU32 0x50000000 = 0x10023004
< Writing 0x10023004 @ address 0x50000000
```

3.3.3.15 reg

Syntax

```
reg <RegName> [= <value>]
```

or

```
reg <RegName> [= (<address>)]
```

Description

Reads or writes from/to given register. If <value> is specified, this command writes the value into the given register. If <address> is specified, this command writes the memory content at address <address> to register <RegName>. Otherwise this command reads the given register.

Example

```
#Write value to register:
> monitor reg pc    = 0x00100230
< Writing register (PC = 0x00100230)

#Write value from address to register:
> monitor reg r0    = (0x00000040)
< Writing register (R0 = 0x14813004)

#Read register value:
> monitor reg PC
< Reading register (PC = 0x00100230)
```

3.3.3.16 regs**Syntax**

```
regs
```

Description

Reads all CPU registers.

Example

```
> monitor regs
< PC = 00100230, CPSR = 20000013 (SVC mode, ARM)
R0 = 14813004, R1 = 00000001, R2 = 00000001, R3 = 000003B5
R4 = 00000000, R5 = 00000000, R6 = 00000000, R7 = 00000000
USR: R8 =00000000, R9 =00000000, R10=00000000, R11 =00000000, R12 =00000000
    R13=00000000, R14=00000000
FIQ: R8 =00000000, R9 =00000000, R10=00000000, R11 =00000000, R12 =00000000
    R13=00200000, R14=00000000, SPSR=00000010
SVC: R13=002004E8, R14=0010025C, SPSR=00000010
ABT: R13=00200100, R14=00000000, SPSR=00000010
IRQ: R13=00200100, R14=00000000, SPSR=00000010
UND: R13=00200100, R14=00000000, SPSR=00000010
```

3.3.3.17 reset**Syntax**

```
reset
```

Description

Resets and halts the target CPU. Make sure the device is selected prior to using this command to make use of the correct reset strategy.

Add. information

There are different reset strategies for different CPUs. Moreover, the reset strategies which are available differ from CPU core to CPU core. J-Link can perform various reset strategies and always selects the best fitting strategy for the selected device.

Example

```
> monitor reset
< Resetting target
```

3.3.3.18 semihosting breakOnError**Syntax**

```
semihosting breakOnError <Value>
```

Description

Enables or disables halting the target at the semihosting breakpoint / in SVC handler if an error occurred during a semihosting command, for example a bad file handle for SYS_WRITE. The GDB Server log window always shows a warning in these cases. breakOnError is disabled by default.

Example

```
#Enable breakOnError:
> monitor semihosting breakOnError 1
```

3.3.3.19 semihosting enable

Syntax

```
semihosting enable [<VectorAddr>]
```

Description

Enables semihosting with the specified vector address. If no vector address is specified, the SWI vector (at address 0x8) will be used. GDBServer will output semihosting terminal data from the target via a separate connection on port 2333. Some IDEs already establish a connection automatically on this port and show terminal data in a specific window in the IDE.

For IDEs which do not support semihosting terminal output directly, the easiest way to view semihosting output is to open a telnet connection to the GDBServer on port 2333. The connection on this port can be opened all the time as soon as GDBServer is started, even before this remote command is executed.

Example

```
> monitor semihosting enable
< Semihosting enabled (VectorAddr = 0x08)
```

3.3.3.20 semihosting IOClient

Syntax

```
semihosting IOClient <ClientMask>
```

Description

GDB itself can handle (file) I/O operations, too. With this command it is selected whether to print output via TELNET port (2333), GDB, or both.

<ClientMask> is

- 1 for TELNET Client (Standard port 2333) (Default)
- 2 for GDB Client
- or 3 for both (Input via GDB Client)

Example

```
#Select TELNET port as output source
> monitor semihosting ioclient 1
< Semihosting I/O set to TELNET Client

#Select GDB as output source
> monitor semihosting ioclient 2
< Semihosting I/O set to GDB Client

#Select TELNET port and GDB as output source
> monitor semihosting ioclient 3
< Semihosting I/O set to TELNET and GDB Client
```

3.3.3.21 semihosting ARMSWI

Syntax

```
semihosting ARMSWI <Value>
```

Description

Sets the SWI number used for semihosting in ARM mode. The default value for the ARMSWI is 0x123456.

Example

```
> monitor semihosting ARMSWI 0x123456
< Semihosting ARM SWI number set to 0x123456
```

3.3.3.22 semihosting ThumbSWI**Syntax**

```
semihosting ThumbSWI <Value>
```

Description

Sets the SWI number used for semihosting in thumb mode. The default value for the ThumbSWI is 0xAB

Example

```
> monitor semihosting ThumbSWI 0xAB
< Semihosting Thumb SWI number set to 0xAB
```

3.3.3.23 setargs**Syntax**

```
setargs <ArgumentString>
```

Description

Set arguments for the application, where all arguments are in one <ArgumentString> separated by whitespaces.

The argument string can be gotten by the application via semihosting command SYS_GET_CMDLINE (0x15).

Semihosting has to be enabled for getting the argumentstring ([semihosting enable](#)). "monitor setargs" can be used before enabeling semihosting.

The maximum length for <ArgumentString> is 512 characters.

Example

```
> monitor setargs test 0 1 2 arg0=4
< Arguments: test 0 1 2 arg0=4
```

3.3.3.24 setbp**Syntax**

```
setbp <Addr> [<Mask>]
```

Description

Sets an instruction breakpoint at the given address, where <Mask> can be 0x03 for ARM instruction breakpoints (Instruction width 4 Byte, mask out lower 2 bits) or 0x01 for THUMB instruction breakpoints (Instruction width 2 Byte, mask out lower bit). If no mask is given, an ARM instruction breakpoint will be set.

Example

```
#Set a breakpoint (implicit for ARM instructions)
> monitor setbp 0x00000000

#Set a breakpoint on a THUMB instruction
> monitor setbp 0x00000100 0x01
```

3.3.3.25 sleep

Syntax

```
sleep <Delay>
```

Description

Sleeps for a given time, where <Delay> is the time period in milliseconds to delay. While sleeping any communication is blocked until the command returns after the given period.

Example

```
> monitor sleep 1000
< Sleep 1000ms
```

3.3.3.26 speed

Note: Deprecated. For setting the initial connection speed, use command line option `-speed` instead.

Syntax

```
speed <kHz>|auto|adaptive
```

Description

Sets the JTAG speed of J-Link / J-Trace. Speed can be either fixed (in kHz), automatic recognition or adaptive. In general, Adaptive is recommended if the target has an RTCK signal which is connected to the corresponding RTCK pin of the device (S-cores only). For detailed information about the different modes, refer to *JTAG Speed* on page 194.

The speed has to be set after selecting the interface, to change it from its default value.

Example

```
> monitor speed auto
< Select auto target interface speed (8000 kHz)

> monitor speed 4000
< Target interface speed set to 4000 kHz

> monitor speed adaptive
< Select adaptive clocking instead of fixed JTAG speed
```

3.3.3.27 step

Syntax

```
step [<NumSteps>]
```

or

```
si [<NumSteps>]
```

Description

Performs one or more single instruction steps, where <NumSteps> is the number of instruction steps to perform. If <NumSteps> is not specified only one instruction step will be performed.

Example

```
> monitor step 3
```

3.3.3.28 SWO DisableTarget

Syntax

```
SWO DisableTarget <PortMask[0x01-0xFFFFFFFF]>
```

Description

Disables the output of SWO data on the target (Undoes changes from SWO Enable-Target) and stops J-Link to capture it.

Example

```
#Disable captureing SWO from stimulus ports 0 and 1
> monitor SWO DisableTarget 3
< SWO disabled succesfully.
```

3.3.3.29 SWO EnableTarget

Syntax

```
SWO EnableTarget <CPUFreq[Hz]> <SWOFreq[Hz]> <PortMask[0x01-0xFFFFFFFF]
<Mode[0]>
```

Description

Configures the target to be able to output SWO data and starts J-Link to capture it. CPU and SWO frequency can be 0 for auto-detection.

If CPUFreq is 0, J-Link will measure the current CPU speed.

If SWOFreq is 0, J-Link will use the highest available SWO speed for the selected / measured CPU speed.

Note: CPUFreq has to be the speed at which the target will be running when doing SWO.

If the speed is different from the current speed when issuing CPU speed auto-detection, getting SWO data might fail.

SWOFreq has to be a quotient of the CPU and SWO speeds and their prescalers. To get available speed, use SWO GetSpeedInfo.

PortMask can be a decimal or hexadecimal Value. Values starting with the Prefix "0x" are handled hexadecimal.

Example

```
#Configure SWO for stimulus port 0, measure CPU frequency and calculate SWO frequency
> monitor SWO EnableTarget 0 0 1 0
< SWO enabled succesfully.
```

```
#Configure SWO for stimulus ports 0-2, fixed SWO frequency and measure CPU frequency
> monitor SWO EnableTarget 0 1200000 5 0
< SWO enabled succesfully.
```

```
#Configure SWO for stimulus ports 0-255, fixed CPU and SWO frequency
> monitor SWO EnableTarget 72000000 6000000 0xFF 0
< SWO enabled succesfully.
```

3.3.3.30 SWO GetMaxSpeed

Syntax

```
SWO GetMaxSpeed <CPUFrequency [Hz]>
```

Description

Prints the maximum SWO speed supported by and matching both, J-Link and the target CPU frequency.

Example

```
#Get SWO speed for 72MHz CPU speed
> monitor SWO GetMaxSpeed 72000000
< Maximum supported SWO speed is 6000000 Hz.
```

3.3.3.31 SWO GetSpeedInfo

Syntax

```
SWO GetSpeedInfo
```

Description

Prints the base frequency and the minimum divider of the connected J-Link. With this, the available SWO speeds for J-Link can be calculated and the matching one for the target CPU frequency can be selected.

Example

```
> monitor SWO GetSpeedInfo
< Base frequency: 60000000Hz, MinDiv: 8
# Available SWO speeds for J-Link are: 7.5MHz, 6.66MHz, 6MHz, ...
```

3.3.3.32 waithalt

Syntax

```
waithalt <Timeout>
```

or

```
wh <Timeout>
```

Description

Waits for target to halt code execution, where <Timeout> is the maximum time period in milliseconds to wait.

Example

```
#Wait for halt with a timeout of 2 seconds
> monitor waithalt 2000
```

3.3.3.33 wice

Syntax

```
wice <RegIndex> <value>
```

or

```
rmib <RegIndex> <value>
```

Description

Writes to given IceBreaker register, where <value> is the data to write.

Example

```
> monitor wice 0x0C 0x100
```

3.3.4 SEGGER-specific GDB protocol extensions

J-Link GDB Server implements some functionality which are not part of the standard GDB remote protocol in general query packets. These SEGGER-specific general query packets can be sent to GDB Server on the low-level of GDB, via maintenance commands, or with a custom client connected to GDB Server.

General query packets start with a 'q'. SEGGER-specific general queries are followed by the identifier 'Segger' plus the command group, the actual command and its parameters.

Following SEGGER-specific general query packets are available:

Query Packet	Explanation
qSeggerSTRACE:config	Configure STRACE for usage.
qSeggerSTRACE:start	Start STRACE.
qSeggerSTRACE:stop	Stop STRACE.
qSeggerSTRACE:read	Read STRACE data.

Table 3.5: General Queries

3.3.4.1 qSeggerSTRACE:config

Syntax

qSeggerSTRACE:config:<ConfigString>

Parameter

ConfigString: String containing the configuration data separating settings by ';'.

Description

Configures STRACE for usage. Configuration for example includes specification of the trace port width to be used for tracing (1-bit, 2-bit, 4-bit (default) Port-Width=%Var%).

Note: For more information please refer to *UM08002* (J-Link SDK user guide), chapter *STRACE*.

Response

<ReturnValue>

ReturnValue is a 4 Byte signed integer.

>= 0 O.K.
< 0 Error.

Note: ReturnValue is hex-encoded.
Return value 0 is "00000000", return value -1 is "FFFFFFFF".

3.3.4.2 qSeggerSTRACE:start

Syntax

qSeggerSTRACE:start

Description

Starts capturing of STRACE data.

Note: For more information please refer to *UM08002* (J-Link SDK user guide), chapter *STRACE*.

Response

<ReturnValue>

ReturnValue is a 4 Byte signed integer.

>= 0 O.K.
< 0 Error.

Note: ReturnValue is hex-encoded.
Return value 0 is "00000000", return value -1 is "FFFFFFFF".

3.3.4.3 qSeggerSTRACE:stop

Syntax

qSeggerSTRACE:stop

Description

Stops capturing of STRACE data.

Note: For more information please refer to *UM08002* (J-Link SDK user guide), chapter *STRACE*.

Response

<ReturnValue>

ReturnValue is a 4 Byte signed integer.

>= 0 O.K.
< 0 Error.

Note: ReturnValue is hex-encoded.
Return value 0 is "00000000", return value -1 is "FFFFFFFF".

3.3.4.4 qSeggerSTRACE:read

Syntax

qSeggerSTRACE:read:<NumItems>

Parameter

NumItems: Maximum number of trace data (addresses) to be read. Hexadecimal.

Description

Read the last recently called instruction addresses. The addresses are returned LIFO, meaning the last recent address is returned first.

Note: For more information please refer to *UM08002* (J-Link SDK user guide), chapter *STRACE*.

Response

<ReturnValue> [<Item0><Item1>...]

ReturnValue is a 4 Byte signed integer.

>= 0 Number of items read.
< 0 Error.

ItemN is a 4 Byte unsigned integer.

0x00000000 - 0xFFFFFFFF Address of the executed instruction

Note: ReturnValue and ItemN are hex-encoded.
e.g. 3 Items read: 0x08000010, 0x08000014, 0x08000018
Response will be: 00000003080000100800001408000018

3.3.5 Command line options

There are several command line options available for the GDB Server which allow configuration of the GDB Server before any connection to a J-Link is attempted or any connection from a GDB client is accepted.

Note: Using GDB Server CL, device, interface, endian and speed are mandatory options to correctly connect to the target, and should be given before connection via GDB. Using GDB Server GUI the mandatory options can also be selected in the configuration dialog.

Command line option	Explanation
<code>-device</code>	Select the connected target device.
<code>-endian</code>	Select the device endianness.
<code>-if</code>	Select the interface to connect to the target.
<code>-speed</code>	Select the target communication speed.

Table 3.6: Mandatory command line options

Note: Using multiple instances of GDB Server, setting custom values for port, SWOPort and TelnetPort is necessary.

Command line option	Explanation
<code>-port</code>	Select the port to listen for GDB clients.
<code>-swoport</code>	Select the port to listen for clients for SWO RAW output.
<code>-telnetport</code>	Select the port to listen for clients for printf output.

Table 3.7: Port selection command line options

The GDB Server GUI version uses persistent settings which are saved across different instances and sessions of GDB Server. These settings can be toggled via the checkboxes in the GUI.

Note: GDB Server CL always starts with the settings marked as default.

For GUI and CL, the settings can be changed with following command line options. For all persistent settings there is a pair of options to enable or disable the feature.

Command line option	Explanation
<code>-ir</code> <code>-noir</code>	Initialize the CPU registers on start of GDB Server. (Default) Do not initialize CPU registers on start of GDB Server.
<code>-localhostonly</code> <code>-nolocalhostonly</code>	Allow only localhost connections (Windows default) Allow connections from outside localhost (Linux default)
<code>-logtofile</code> <code>-nologtofile</code>	Generate a GDB Server log file. Do not generate a GDB Server log file. (Default)
<code>-halt</code> <code>-nohalt</code>	Halt the target on start of GDB Server. Do not halt the target on start of GDB Server. (Default)
<code>-silent</code> <code>-nosilent</code>	Do not show log output. Show log output. (Default)
<code>-stayontop</code> <code>-nostayontop</code>	Set the GDB Server GUI to be the topmost window. Do not be the topmost window. (Default)
<code>-timeout</code> <code>-notimeout</code>	Set the time after which the target has to be connected. Set infinite timeout for target connection.
<code>-vd</code> <code>-novd</code>	Verify after downloading. Do not verify after downloading. (Default)

Table 3.8: Persistent command line options

Following additional command line options are available. These options are temporary for each start of GDB Server.

Command line option	Explanation
<code>-excdbg</code>	Enable exception debugging.
<code>-jtagconf</code>	Configures a JTAG scan chain with multiple devices on it.
<code>-log</code>	Logs the GDB Server communication to a specific file.
<code>-rtos</code>	Selects a RTOS plugin (DLL file)
<code>-singlerun</code>	Starts GDB Server in single run mode.
<code>-scriptfile</code>	Uses a J-Link scriptfile.
<code>-select</code>	Selects the interface to connect to J-Link (USB/IP).
<code>-settingsfile</code>	Selects the J-Link Settings File.
<code>-strict</code>	Starts GDB Server in strict mode.
<code>-x</code>	Executes a gdb file on first connection.
<code>-xc</code>	Executes a gdb file on every connection.
<code>-cpu</code>	Selects the CPU core. Deprecated, use <code>-device</code> instead.

Table 3.9: General command line options

3.3.5.1 -cpu

Description

Pre-select the CPU core of the connected device, so the GDB Server already knows the register set, even before having established a connection to the CPU.

Note: Deprecated, please use `-device` instead. Anyhow, it does not hurt if this option is set, too.

Syntax

```
-CPU <CPUCore>
```

Example

```
jlinkgdbserver -CPU ARM7_9
```

Add. information

The following table lists all valid values for `<CPUCore>`:

<code><CPUCore></code>	Supported CPU cores
CPU_FAMILY_ARM7_9	Pre-select ARM7 and ARM9 as CPU cores.
CPU_FAMILY_CORTEX_A_R	Pre-select Cortex-A and Cortex-R as CPU cores.
CPU_FAMILY_CORTEX_M	Pre-select Cortex-M as CPU core.
CPU_FAMILY_RX600	Pre-select Renesas RX600 as CPU core.

Table 3.10: GDB allowed values for CPUCore

3.3.5.2 -device

Description

Tells GDBServer to which device J-Link is connected before the connect sequence is actually performed. It is recommended to use the command line option to select the device instead of using the remote command since for some devices J-Link already needs to know the device at the time of connecting to it since some devices need special connect sequences (e.g. devices with TI ICEPick modules). In such cases, it is not possible to select the device via remote commands since they are configured after the GDB client already connected to GDBServer and requested the target registers which already requires a connection to the target.

Note: Using GDB Server CL this option is mandatory to correctly connect to the target, and should be given before connection via GDB.

Syntax

```
-device <DeviceName>
```

Example

```
jlinkgdbserver -device AT91SAM7SE256
```

Add. information

For a list of all valid values for `<DeviceName>`, please refer to http://www.segger.com/jlink_supported_devices.html.

3.3.5.3 -endian

Description

Sets the endianness of the target where endianness can either be "little" or "big".

Note: Using GDB Server CL this option is mandatory to correctly connect to the target, and should be given before connection via GDB.

Syntax

```
-endian <endianess>
```

Example

```
jlinkgdbserver -endian little
```

3.3.5.4 -if

Description

Selects the target interface which is used by J-Link to connect to the device. The default value is JTAG.

Note: Using GDB Server CL this option is mandatory to correctly connect to the target, and should be given before connection via GDB.

Syntax

```
-if <Interface>
```

Example

```
jlinkgdbserver -if SWD
```

Add. information

Currently, the following values are accepted for <Interface>:

- JTAG
- SWD
- FINE
- 2-wire-JTAG-PIC32

3.3.5.5 -ir

Description

Initializes the CPU register with default values on startup.

Note: For the GUI version, this setting is persistent for following uses of GDB Server until changed via -noir or the GUI.

Example

```
jlinkgdbserver -ir
```

3.3.5.6 -excdbg

Syntax

```
-excdbg <nSteps>
```

Description

Enables exception debugging. Exceptions on ARM CPUs are handled by exception handlers. Exception debugging makes the debugging of exceptions more user-friendly by passing a signal to the GDB client and returning to the causative instruction.

In order to do this, a special exception handler is required as follows:

```
__attribute__((naked)) void OnHardFault(void){
    __asm volatile (
        " bkpt 10 \n"
        " bx lr  \n"
    );
}
```

The signal passed to the GDB client is the immediate value (10 in the example) of the software breakpoint instruction. `<nSteps>` specifies, how many instructions need to be executed until the exception return occurs. In most cases this will be 2 (which is the default value), if the handler function is set as the exception handler. If it is called indirectly as a subroutine from the exception handler, there may be more steps required.

It is mandatory to have the function declared with the "naked" attribute and to have the `bx lr` instruction immediately after the software breakpoint instruction. Otherwise the software breakpoint will be treated as a usual breakpoint.

Example

```
jlinkgdbserver -excdbg 4
```

3.3.5.7 -jtagconf

Syntax

```
-jtagconf <IRPre>,<DRPre>
```

Description

Configures a JTAG scan chain with multiple devices on it. `<IRPre>` is the sum of IRLens of all devices closer to TDI, where IRLen is the number of bits in the IR (Instruction Register) of one device. `<DRPre>` is the number of devices closer to TDI. For more detailed information of how to configure a scan chain with multiple devices please refer to See "Determining values for scan chain configuration" on page 193..

Example

```
#Select the second device, where there is 1 device in front with IRLen 4
jlinkgdbserver -jtagconf 4,1
```

3.3.5.8 -localhostonly

Description

Starts the GDB Server with the option to listen on localhost only (This means that only TCP/IP connections from localhost are accepted) or on any IP address. To allow remote debugging (connecting to GDBServer from another PC), deactivate this option.

If no parameter is given, it will be set to 1 (active).

Note: For the GUI version, this setting is persistent for following uses of GDB Server until changed via command line option or the GUI.

Syntax

```
-LocalhostOnly <State>
```

Example

```
jlinkgdbserver -LocalhostOnly 0 //Listen on any IP address (Linux/MAC default)
jlinkgdbserver -LocalhostOnly 1 //Listen on localhost only (Windows default)
```

3.3.5.9 -log

Description

Starts the GDB Server with the option to write the output into a given log file. The file will be created if it does not exist. If it exists the previous content will be removed. Paths including spaces need to be set between quotes.

Syntax

```
-log <LogFilePath>
```

Example

```
jlinkgdbserver -log "C:\my path\to\file.log"
```

3.3.5.10 -logtofile

Description

Starts the GDB Server with the option to write the output into a log file.

If no file is given via `-log`, the log file will be created in the GDB Server application directory.

Note: For the GUI version, this setting is persistent for following uses of GDB Server until changed via `-nologtofile` or the GUI.

Syntax

```
-logtofile
```

Example

```
jlinkgdbserver -logtofile
```

```
jlinkgdbserver -logtofile -log "C:\my path\to\file.log"
```

3.3.5.11 -halt

Description

Halts the target after connecting to it on start of GDB Server.

For most IDEs this option is mandatory since they rely on the target to be halted after connecting to GDB Server.

Note: For the GUI version, this setting is persistent for following uses of GDB Server until changed via `-nohalt` or the GUI.

Syntax

```
-halt
```

Example

```
jlinkgdbserver -halt
```

3.3.5.12 -noir

Description

Do not initialize the CPU registers on startup.

Note: For the GUI version, this setting is persistent for following uses of GDB Server until changed via `-ir` or the GUI.

Syntax

```
-noir
```

3.3.5.13 -nolocalhostonly

Description

Starts GDB Server with the option to allow remote connections (from outside local-host).

Same as `-localhostonly 0`

Note: For the GUI version, this setting is persistent for following uses of GDB Server until changed via command line option or the GUI.

Syntax

```
-nolocalhostonly
```

3.3.5.14 -nologtofile

Description

Starts the GDB Server with the option to not write the output into a log file.

Note: For the GUI version, this setting is persistent for following uses of GDB Server until changed via -nologtofile or the GUI.

Note: When this option is used after -log, no log file will be generated, when -log is used after this option, a log file will be generated and this setting will be overridden.

Syntax

```
-nologtofile
```

Example

```
jlinkgdbserver -nologtofile // Will not generate a log file
jlinkgdbserver -nologtofile -log "C:\pathto\file.log" // Will generate a log file
jlinkgdbserver -log "C:\pathto\file.log" -nologtofile // Will not generate a log file
```

3.3.5.15 -nohalt

Description

When connecting to the target after starting GDB Server, the target is not explicitly halted and the CPU registers will not be initied.

After closing all GDB connections the target is started again and continues running.

Some IDEs rely on the target to be halted after connect. In this case do not use -nohalt, but -halt.

Note: For the GUI version, this setting is persistent for following uses of GDB Server until changed via -halt or the GUI.

Syntax

```
-nohalt
```

Example

```
jlinkgdbserver -nohalt
```

3.3.5.16 -nosilent

Description

Starts the GDB Server in non-silent mode. All log window messages will be shown.

Note: For the GUI version, this setting is persistent for following uses of GDB Server until changed via command line option or the GUI.

Syntax

```
-nosilent
```

3.3.5.17 -nostayontop

Description

Starts the GDB Server in non-topmost mode. All windows can be placed above it.

Note: For the CL version this setting has no effect.

Note: For the GUI version, this setting is persistent for following uses of GDB Server until changed via command line option or the GUI.

Syntax

```
-nostayontop
```

3.3.5.18 -notimeout

Description

GDB Server automatically closes after a timeout of 5 seconds when no target voltage can be measured or connection to target fails.

This command line option prevents GDB Server from closing, to allow connecting a target after starting GDB Server.

Note: The recommended order is to power the target, connect it to J-Link and then start GDB Server.

Syntax

```
-notimeout
```

3.3.5.19 -novd

Description

Do not explicitly verify downloaded data.

Note: For the GUI version, this setting is persistent for following uses of GDB Server until changed via command line option or the GUI.

Syntax

```
-vd
```

3.3.5.20 -port

Description

Starts GDB Server listening on a specified port. This option overrides the default listening port of the GDB Server. The default port is 2331.

Note: Using multiple instances of GDB Server, setting custom values for this option is necessary.

Syntax

```
-port <Port>
```

Example

```
jlinkgdbserver -port 2345
```

3.3.5.21 -rtos

Description

Specifies a RTOS plug-in (.DLL file for Windows, .SO file for Linux and Mac). If the file-name extension is not specified, it is automatically added depending on the PC's operating system.

The J-Link software and documentation package comes with RTOS plug-ins for embOS and FreeRTOS pre-installed in the sub-directory "GDBServer". A software development kit (SDK) for creating your own plug-ins is also available upon request.

Syntax

```
-rtos <filename>[.dll|.so]
```

Example

```
jlinkgdbserver -rtos GDBServer\RTOSPlugin_embOS
```

3.3.5.22 -scriptfile

Description

Passes the path of a J-Link script file to the GDB Server. This scriptfile is executed before the GDB Server starts the debugging / identifying communication with the target. J-Link scriptfiles are mainly used to connect to targets which need a special connection sequence before communication with the core is possible. For more information about J-Link script files, please refer to *J-Link script files* on page 216.

Syntax

```
-scriptfile <ScriptFilePath>
```

Example

```
-scriptfile "C:\My Projects\Default.JLinkScript"
```

3.3.5.23 -select

Description

Specifies the host interface to be used to connect to J-Link. Currently, USB and TCP/IP are available.

Syntax

```
-select <Interface>=<SerialNo>/<IPAddr>
```

Example

```
jlinkgdbserver -select usb=580011111
jlinkgdbserver -select ip=192.168.1.10
```

Additional information

For backward compatibility, when USB is used as interface serial numbers from 0-3 are accepted as USB=0-3 to support the old method of connecting multiple J-Links to a PC. This method is no longer recommended to be used. Please use the "connect via emulator serial number" method instead.

3.3.5.24 -settingsfile

Description

Select a J-Link settings file to be used for the target device. The settings fail can contain all configurable options of the Settings tab in J-Link Control panel.

Syntax

```
-SettingsFile <PathToFile>
```

Example

```
jlinkgdbserver -SettingsFile "C:\Temp\GDB Server.jlink"
```

3.3.5.25 -silent

Description

Starts the GDB Server in silent mode. No log window messages will be shown.

Note: For the GUI version, this setting is persistent for following uses of GDB Server until changed via command line option or the GUI.

Syntax

```
-silent
```

3.3.5.26 -singlerun

Description

Starts GDB Server in single run mode. When active, GDB Server will close when all client connections are closed.

In normal run mode GDB Server will stay open and wait for new connections.

When started in single run mode GDB Server will close immediately when connecting to the target fails. Make sure it is powered and connected to J-Link before starting GDB Server.

Syntax

```
-s  
-singlerun
```

3.3.5.27 -speed

Description

Starts GDB Server with a given initial speed.

Available parameters are "adaptive", "auto" or a freely selectable integer value in kHz. It is recommended to use either a fixed speed or, if it is available on the target, adaptive speeds.

Note: Using GDB Server CL this option is mandatory to correctly connect to the target, and should be given before connection via GDB.

Syntax

```
-speed <Speed_kHz>
```

Example

```
jlinkgdbserver -speed 2000
```

3.3.5.28 -stayontop

Description

Starts the GDB Server in topmost mode. It will be placed above all non-topmost windows and maintains its position even when it is deactivated.

Note: For the CL version this setting has no effect.

Note: For the GUI version, this setting is persistent for following uses of GDB Server until changed via command line option or the GUI.

Syntax

```
-stayontop
```

3.3.5.29 -timeout

Description

Set the timeout after which the target connection has to be established. If no connection could be established GDB Server will close.

The default timeout is 5 seconds for the GUI version and 0 for the command line version.

Note: The recommended order is to power the target, connect it to J-Link and then start GDB Server.

Syntax

```
-timeout <Timeout[ms]>
```

Example

Allow target connection within 10 seconds.

```
jlinkgdbserver -timeout 10000
```

3.3.5.30 -strict

Description

Starts GDB Server in strict mode. When strict mode is active GDB Server checks the correctness of settings and exits in case of a failure.

Currently the device name is checked. If no device name is given or the device is unknown to the J-Link, GDB Server exits instead of selecting "Unspecified" as device or showing the device selection dialog.

Syntax

```
- strict
```

Example

Following executions of GDB Server (CL) will cause exit of GDB Server.

```
jlinkgdbserver -strict -device UnknownDeviceName
```

```
jlinkgdbservercl -strict
```

Following execution of GDB Server will show the device selection dialog under Windows or select "Unspecified" directly under Linux / OS X.

```
jlinkgdbserver -device UnknownDeviceName
```

3.3.5.31 -swoport

Description

Set up port on which GDB Server should listen for an incoming connection that reads the SWO data from GDB Server. Default port is 2332.

Note: Using multiple instances of GDB Server, setting custom values for this option is necessary.

Syntax

```
-SWOPort <Port>
```

Example

```
jlinkgdbserver -SWOPort 2553
```

3.3.5.32 -telnetport

Description

Set up port on which GDB Server should listen for an incoming connection that gets target's printf data (Semihosting and analyzed SWO data). Default port is 2333.

Note: Using multiple instances of GDB Server, setting custom values for this option is necessary.

Syntax

```
-TelnetPort <Port>
```

Example

```
jlinkgdbserver -TelnetPort 2554
```

3.3.5.33 -vd

Description

Verifys the data after downloading it.

Note: For the GUI version, this setting is persistent for following uses of GDB Server until changed via command line option or the GUI.

Syntax

```
-vd
```

3.3.5.34 -x

Description

Starts the GDB Server with a gdbinit (configuration) file. In contrast to the `-xc` command line option the GDB Server runs the commands in the gdbinit file once only direct after the first connection of a client.

Syntax

```
-x <ConfigurationFilePath>
```

Example

```
jlinkgdbserver -x C:\MyProject\Sample.gdb
```

3.3.5.35 -xc

Description

Starts the GDB Server with a gdbinit (configuration) file. GDB Server executes the commands specified in the gdbinit file with every connection of a client / start of a debugging session.

Syntax

```
-xc <ConfigurationFilePath>
```

Example

```
jlinkgdbserver -xc C:\MyProject\Sample.gdb
```

3.3.6 Program termination

J-Link GDB Server is normally terminated by a close or Ctrl-C event. When the single run mode is active it will also close when an error occurred during start or after all connections to GDB Server are closed.

On termination GDB Server will close all connections and disconnect from the target device, letting it run.

3.3.6.1 Exit codes

J-Link GDB Server terminates with an exit code indicating an error by a non-zero exit code.

The following table describes the defined exit codes of GDB Server.

Exit code	Description
0	No error. GDB Server closed normally.
-1	Unknown error. Should not happen.
-2	Failed to open listener port (Default: 2331)
-3	Could not connect to target. No target voltage detected or connection failed.
-4	Failed to accept a connection from GDB.
-5	Failed to parse the command line options, wrong or missing command line parameter.
-6	Unknown or no device name set.
-7	Failed to connect to J-Link.

Table 3.11: GDB Server exit codes

3.3.7 Semihosting

Semihosting can be used with J-Link GDBServer and GDB based debug environments but needs to be explicitly enabled. For more information, please refer to *Enabling semihosting in J-Link GDBServer* on page 463.

3.4 J-Link Remote Server

J-Link Remote Server allows using J-Link / J-Trace remotely via TCP/IP. This enables you to connect to and fully use a J-Link / J-Trace from another computer. Performance is just slightly (about 10%) lower than with direct USB connection.

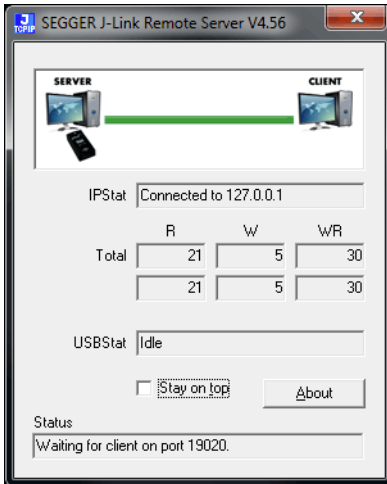

The J-Link Remote Server also accepts commands which are passed to the J-Link Remote Server via the command line.

3.4.1 List of available commands

The table below lists the commands accepted by the J-Link Remote Server

Command	Description
<code>port</code>	Selects the IP port on which the J-Link Remote Server is listening.
<code>SelectEmuBySN</code>	Selects the J-Link to connect to by its Serial Number.

Table 3.12: Available commands

3.4.1.1 port

Syntax

```
-port <Portno.>
```

Example

To start the J-Link Remote Server listening on port 19021 the command should look as follows:

```
-port 19021
```

3.4.1.2 SelectEmuBySN

Syntax

```
-SelectEmuBySN <S/N>
```

Example

To select the emulator with Serial Number 268000000 the command should look as follows:

```
-SelectEmuBySN 268000000
```

3.4.2 Tunneling mode

The Remote server provides a tunneling mode which allows remote connection to a J-Link / J-Trace from any computer, even from outside the local network.

To give access to a J-Link neither a remote desktop or vpn connection nor changing some difficult firewall settings is necessary.

When started in tunneling mode the Remote server connects to the SEGGER tunnel server via port 19020 and registers with its serial number. To connect to the J-Link from the remote computer an also simple connection to tunnel:<SerialNo> can be established and the debugger is connected to the J-Link.

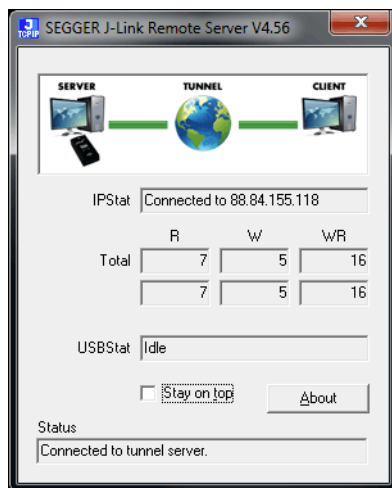
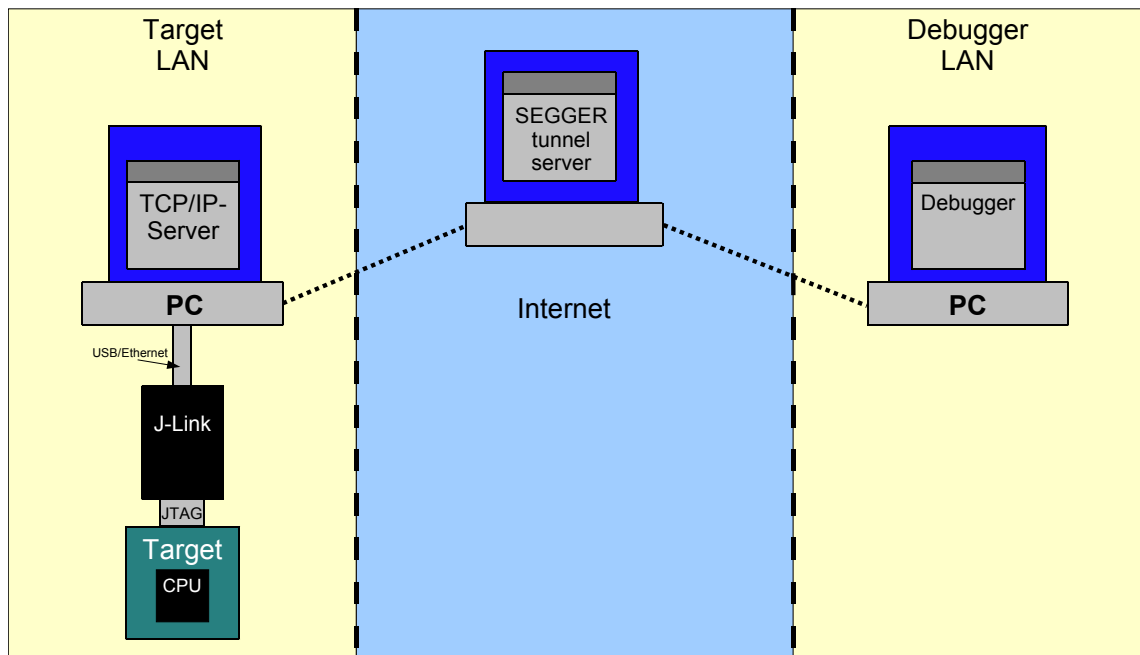

Example scenario

A device vendor is developing a new device which shall be supported by J-Link. Because there is only one prototype, a shipment to SEGGER is not possible.

Instead the vendor can connect the device via J-Link to a local computer and start the Remote server in tunneling mode. The serial number of the J-Link is then sent to a to an engineer at SEGGER.

The engineer at SEGGER can use J-Link Commander or a debugger to test and debug the new device without the need to have the device on the desk.

Start J-Link Remote Server in tunneling mode

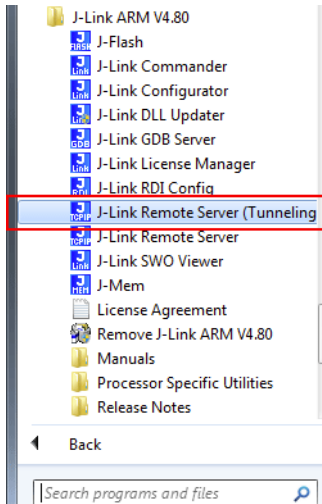

Connect to the J-Link / J-Trace via J-Link commander

J-Link Commander can be used to verify a connection to the J-Link can be established as follows:

Start J-Link Commander

From within J-Link Commander enter

```
ip tunnel:<SerialNo>
```

If the connection was successful it should look like in this screenshot.

```
J-Link ARM V4.54
SEGGER J-Link Commander V4.54 ('?' for help)
Compiled Sep 11 2012 18:33:18
Can not connect to J-Link via USB.
J-Link>ip tunnel:59000000
Connecting to tunnel:59000000
DLL version V4.54, compiled Sep 11 2012 18:32:59
Firmware: J-Link V9 compiled Oct 2 2012 09:11:43
Hardware: V9.00
S/N: 59000000
VTarget = 3.312V
Info: TotalIRLen = 9, IRPrint = 0x0011
Info: Found Cortex-M4 r0p1, Little endian.
Info: TPIU fitted.
Info: ETM fitted.
Info: FPUunit: 6 code <BP> slots and 2 literal slots
Found 2 JTAG devices, Total IRLen = 9:
 #0 Id: 0x4BA00477, IRLen: 04, IRPrint: 0x1, CoreSight JTAG-DP (ARM)
 #1 Id: 0x06413041, IRLen: 05, IRPrint: 0x1, STM32 Boundary Scan
Cortex-M4 identified.
JTAG speed: 100 kHz
J-Link>
```

Troubleshooting

Problem	Solution
Remote server cannot connect to tunnel server.	<ol style="list-style-type: none"> 1. Make sure the Remote server is not blocked by any firewall. 2. Make sure port 19020 is not blocked by any firewall. 3. Contact network admin.
J-Link Commander cannot connect to tunnel server.	<ol style="list-style-type: none"> 1. Make sure Remote server is started correctly. 2. Make sure the entered serial number is correct. 3. Make sure port 19020 is not blocked by any firewall. Contact network admin.

Table 3.13:

To test whether a connection to the tunnel server can be established or not a network protocol analyzer like Wireshark can help.

The network transfer of a successful connection should look like:

Source	Destination	Protocol	Info
192.168.11.31	88.84.155.118	TCP	51439 > j-link [SYN] Seq=0 win=8192
88.84.155.118	192.168.11.31	TCP	j-link > 51439 [SYN, ACK] Seq=0 Ack=51439
192.168.11.31	88.84.155.118	TCP	51439 > j-link [ACK] Seq=1 Ack=1
192.168.11.31	88.84.155.118	TCP	51439 > j-link [PSH, ACK] Seq=5 Ack=1
192.168.11.31	88.84.155.118	TCP	51439 > j-link [PSH, ACK] Seq=5 Ack=1
88.84.155.118	192.168.11.31	TCP	j-link > 51439 [ACK] Seq=1 Ack=5
88.84.155.118	192.168.11.31	TCP	j-link > 51439 [ACK] Seq=1 Ack=9
88.84.155.118	192.168.11.31	TCP	j-link > 51439 [PSH, ACK] Seq=1 Ack=9
192.168.11.31	88.84.155.118	TCP	51439 > j-link [PSH, ACK] Seq=9 Ack=1
192.168.11.31	88.84.155.118	TCP	51439 > j-link [PSH, ACK] Seq=13 Ack=1
88.84.155.118	192.168.11.31	TCP	j-link > 51439 [ACK] Seq=5 Ack=80

3.6 J-Flash

J-Flash is an application to program data images to the flash of a target device. With J-Flash the internal flash of all J-Link supported devices can be programmed, as well as common external flashes connected to the device. Beside flash programming all other flash operations like erase, blank check and flash content verification can be done.

J-Flash requires an additional license from SEGGER to enable programming. For license keys, as well as evaluation licenses got to <http://www.segger.com> or contact us directly.

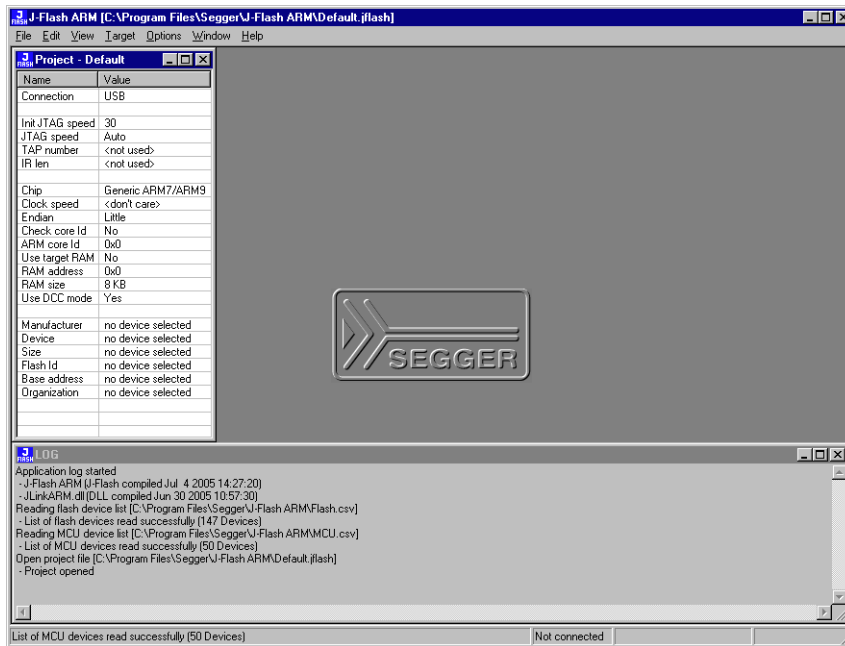

3.7 J-Link RTT Viewer

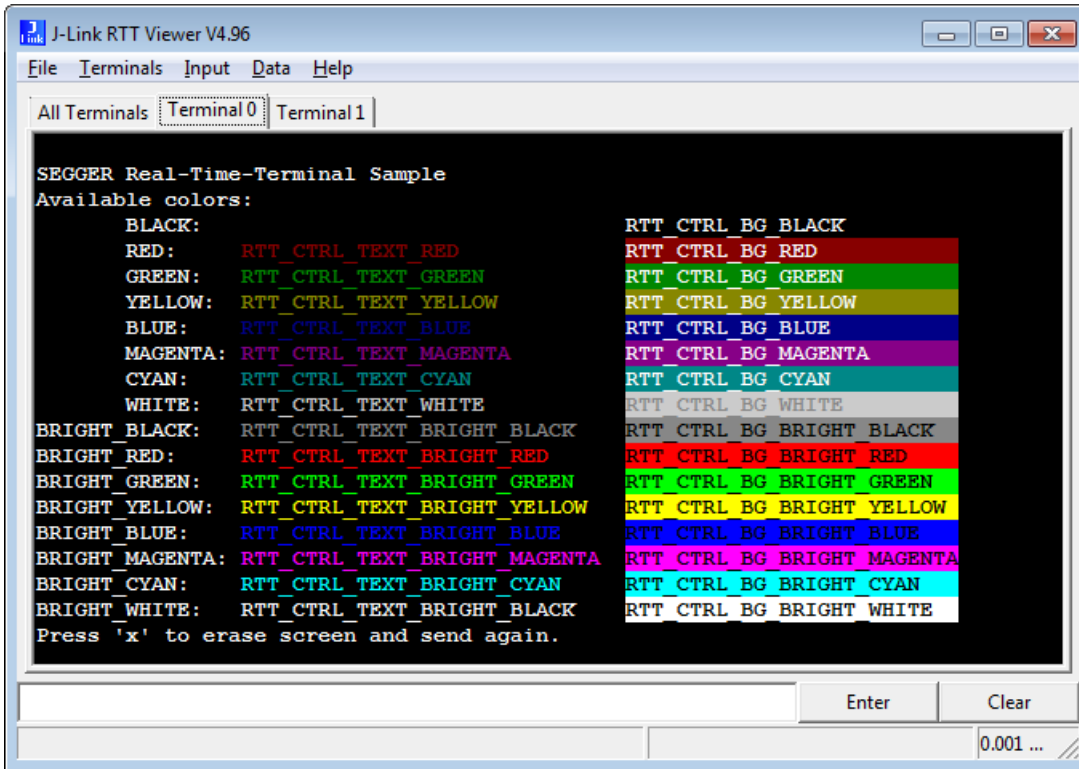

J-Link RTT Viewer is a Windows GUI application to use all features of RTT in one application. It supports:

- Displaying terminal output of Channel 0.
- Up to 16 virtual Terminals on Channel 0.
- Sending text input to Channel 0.
- Interpreting text control codes for colored text and controlling the Terminal.
- Logging terminal data into a file.
- Logging data on Channel 1.

For general information about RTT, please refer to *RTT* on page 365.

3.7.1 RTT Viewer Startup

Make sure J-Link and target device are connected and powered up.

Start RTT Viewer by opening the executable (JLinkRTTViewer.exe) from the installation folder of the J-Link Software or the start menu. Unless the command line parameter `-autoconnect` is set, the Configuration Dialog will pop up.

Configure the Connection Settings as described below and click OK. The connection settings and all in app configuration will be saved for the next start of J-Link RTT Viewer.

3.7.2 Connection Settings

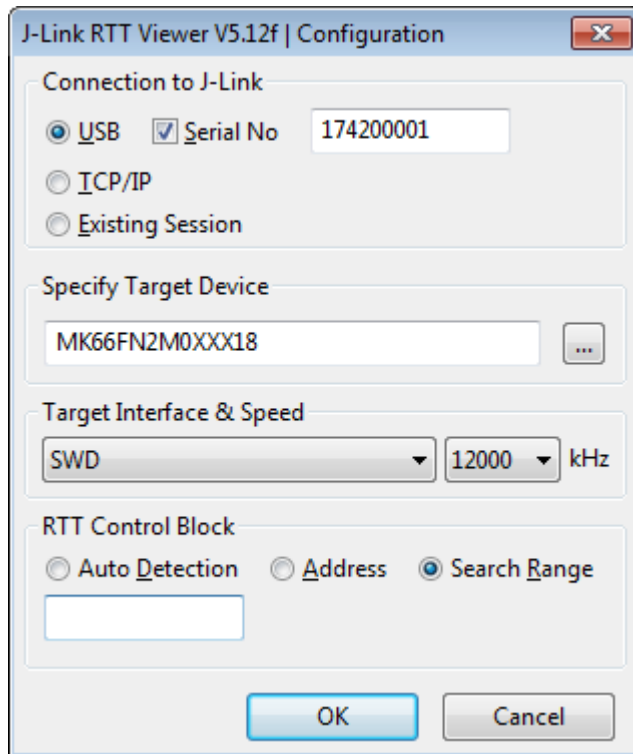

RTT Viewer can be used in two modes:

- Stand-alone, opening an own connection to J-Link and target.
- In attach mode, connecting to an existing J-Link connection of a debugger.

Stand-alone connection settings

In stand-alone mode RTT Viewer needs to know some settings of J-Link and target device.

Select USB or TCP/IP as the connection to J-Link. For USB a specific J-Link serial number can optionally be entered, for TCP/IP the IP or hostname of the J-Link has to be entered.

Select the target device to connect to. This allows J-Link to search in the known RAM of the target.

Select the target interface and its speed.

The RTT Control Block can be searched for fully automatically, it can be set to a fixed address or it can be searched for in one or more specific memory ranges.

Attaching to a connection

In attach mode RTT Viewer does not need any settings. Select Existing Session.

For attach mode a connection to J-Link has to be opened and configured by another application like a debugger or simply J-Link Commander. If the RTT Control Block cannot be found automatically, configuration of its location has to be done by the debugger / application.

3.7.3 The Terminal Tabs

RTT Viewer allows displaying the output of Channel 0 in different "virtual" Terminals.

The target application can switch between terminals with `SEGGER_RTT_SetTerminal()` and `SEGGER_RTT_TerminalOut()`.

RTT Viewer displays the Terminals in different tabs.

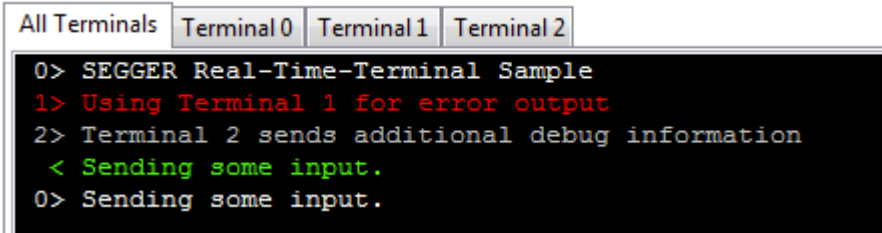

```

All Terminals Terminal0 Terminal1 Terminal2
0> SEGGER Real-Time-Terminal Sample
1> Using Terminal 1 for error output
2> Terminal 2 sends additional debug information
< Sending some input.
0> Sending some input.
  
```

All Terminals

The All Terminals tab displays the complete output of RTT Channel 0 and can display the user input (Check Input -> Echo input... -> Echo to "All Terminals").

Each output line is prefixed by the Terminal it has been sent to. Additionally, output on Terminal 1 is shown in red, output on Terminals 2 - 15 in gray.

Terminal 0 - 15

Each tab Terminal 0 - Terminal 15 displays the output which has been sent to this Terminal. The Terminal tabs interpret and display Text Control Codes as sent by the application to show colored text or erase the screen.

By default, if the RTT application does not set a Terminal Id, the output is displayed in Terminal 0.

The Terminal 0 tab can additionally display the user input. (Check Input -> Echo input... -> Echo to "Terminal 0")

Each Terminal tab can be shown or hidden via the menu Terminals -> Terminals... or their respective shortcuts as described below.

3.7.4 Sending Input

RTT Viewer supports sending user input to RTT Down Channel 0 which can be read by the target application with `SEGGER_RTT_GetKey()` and `SEGGER_RTT_Read()`.

Input can be entered in the text box below the Terminal Tabs.

RTT Viewer can be configured to directly send each character while typing or buffer it until Enter is pressed (Menu Input -> Sending...).

In stand-alone mode RTT Viewer can retry to send input, in case the target input buffer is full, until all data could be sent to the target via Input -> Sending... -> Block if FIFO full.

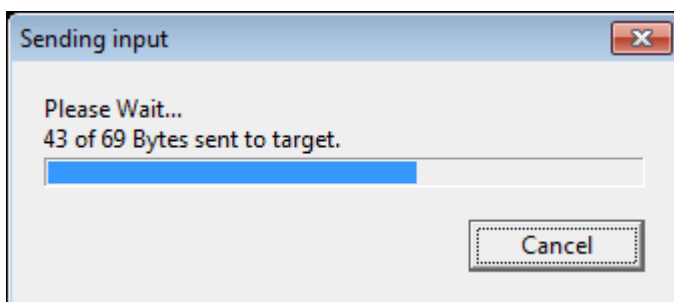

3.7.5 Logging Terminal output

The output of Channel 0 can be logged into a text file. The format is the same as used in the All Terminals tab.

Terminal Logging can be started via Logging -> Start Terminal Logging...

3.7.6 Logging Data

Additionally to displaying output of Channel 0, RTT Viewer can log data which is sent on RTT Channel 1 into a file. This can for example be used to sent instrumented event tracing data. The data log file contains header and footer and the binary data as received from the application.

Data Logging can be started via Logging -> Start Data Logging...

Note: Data Logging is only available in stand-alone mode.

3.7.7 Command line options

J-Link RTT Viewer can be configured via command line parameters. In the following, the command line options which are available for J-Link RTT Viewer are explained. All command line options are case insensitive. Short and long command names have the same syntax.

Command line option	Explanation
-d, --device	Select the connected target device.
-ct, --connection	Sets the connection type
-if, --interface	Sets the interface type
-ip, --host	The IP address of the J-Link
-s, --speed	Interface speed in kHz
-sn, --serialnumber	Select the J-Link with a specific S/N
-ra, --rttaddr	Sets the address of the RTT control block
-rr, --rttrange	Specify RTT search range
-a, --autoconnect	Automatically connect to target, suppress settings dialog

Table 3.14: Command line options

3.7.7.1 --device

Selects the device J-Link RTT Viewer shall connect to.

Syntax

```
--device <DeviceName>
```

Example

```
JLinkRTTViewer.exe --device STM32F103ZE
```

3.7.7.2 --connection

Sets the connection type. The connection to the J-Link can either be made directly over USB, IP or using an existing running session (e.g. the IDE's debug session). In case of using an existing session, no further configuration options are required.

Syntax

```
--connection <usb|ip|sess>
```

Example

```
JLinkRTTViewer.exe --connection ip
```

3.7.7.3 --interface

Sets the interface J-Link shall use to connect to the target. As interface types FINE, JTAG and SWD are supported.

Syntax

```
--interface <fine|jtag|swd>
```

Example

```
JLinkRTTViewer.exe --interface swd
```

3.7.7.4 --host

Enter the IP address or hostname of the J-Link. This option only applies, if connection type IP is used. Use * as <IPAddr> for a list of available J-Links in the local subnet.

Syntax

```
--host <IPAddr>
```

Example

```
JLinkRTTViewer.exe --host 192.168.1.17
```

3.7.7.5 --speed

Sets the interface speed in kHz for target communication.

Syntax

```
--speed <speed>
```

Example

```
JLinkRTTViewer.exe --speed 4000
```

3.7.7.6 --serialnumber

Connect to a J-Link with a specific serial number via USB. Useful if multiple J-Links are connected to the same PC and multiple instances of J-Link RTT Viewer shall run and each connects to another J-Link.

Syntax

```
--serialnumber <SerialNo>
```

Example

```
JLinkRTTViewer.exe --serialnumber 580011111
```

3.7.7.7 --rttaddr

Sets a fixed address as location of the RTT control block. Automatic searching for the RTT control block is disabled. The Address can be

Syntax

```
--rttaddr <RTTCBAddr>
```

Example

```
JLinkRTTViewer.exe -rttaddr 0x20000000
```

3.7.7.8 --rttrange

Sets one or more memory ranges, where the J-Link DLL shall search for the RTT control block.

Syntax

```
--rttrange <RangeStart[Hex]> <RangeSize >[, <Range1Start [Hex]> <Range1Size>]>
```

Example

```
JLinkRTTViewer.exe -rttrange "20000000 400"
```

3.7.7.9 --autoconnect

Let J-Link RTT Viewer connect automatically to the target without showing the Connection Settings (see *Connection Settings* on page 145).

Syntax

```
--autoconnect
```

Example

```
JLinkRTTViewer.exe --autoconnect
```

3.7.8 Menus and Shortcuts

Menu entry	Contents	Shortcut
File		
-> Connect...	Opens the connect dialog and connects to the targets	F2
-> Disconnect	Disconnects from the target	F3
-> Exit	Closes connection and exit RTT Viewer.	Alt-F4
Terminals		
-> Add next terminal	Opens the next available Terminal Tab.	Alt-A
-> Clear active terminal	Clears the currently selected terminal tab.	Alt-R
-> Close active terminal	Closes the active Terminal Tab.	Alt-W
-> Open Terminal on output	If selected, a terminal is automatically created, if data for this terminal is received.	

Table 3.15: RTT Viewer Menus and Shortcuts

Menu entry	Contents	Shortcut
-> Show Log	Opens or closes the Log Tab.	Alt-L
Terminals -> Terminals...		
--> Terminal 0 - 15	Opens or closes the Terminal Tab.	Alt-Shift-0 Alt-Shift-F
Input		
-> Clear input field	Clears the input field without sending entered data.	Button 'Clear'
Input -> Sending...		
--> Send on Input	If selected, entered input will be sent directly to the target while typing.	
--> Send on Enter	If selected, entered input will be sent when pressing Enter.	
--> Block if FIFO full	If checked, RTT Viewer will retry to send all input to the target when the target buffer is full.	
Input -> End of line...		
--> Windows format (CR+LF) --> Unix format (LF) --> Mac format (CR) --> None	Selects the end of line character to be sent on Enter.	
Input -> Echo input...		
--> Echo to "All Terminals"	If checked, sent input will be displayed in the All Terminals Tab.	
--> Echo to "Terminal 0"	If checked, sent input will be displayed in the Terminal Tab 0.	
Logging		
-> Start Terminal logging...	Starts logging terminal data to a file.	F5
-> Stop Terminal logging	Stops logging terminal data and closes the file.	Shift-F5
-> Start Data logging...	Starts logging data of Channel 1 to a file.	F6
-> Stop Data logging	Stops logging data and closes the file.	Shift-F6
Help		
-> About...	Shows version info of RTT Viewer.	F12
-> J-Link Manual...	Opens the J-Link Manual PDF file.	F11
-> RTT Webpage...	Opens the RTT webpage.	F10

Table 3.15: RTT Viewer Menus and Shortcuts

Menu entry	Contents	Shortcut
Right-Click on Tab		
-> Close Terminal	Closes this Terminal Tab	Alt-W
-> Clear Terminal	Clears the displayed output of this Terminal Tab.	Alt-R

Table 3.15: RTT Viewer Menus and Shortcuts

3.7.9 Using "virtual" Terminals in RTT

For virtual Terminals the target application needs only Up Channel 0. This is especially important on targets with low RAM.

If nothing is configured, all data is sent to Terminal 0.

The Terminal to output all following via Write, WriteString or printf can be set with SEGGER_RTT_SetTerminal() .

Output of only one string via a specific Terminal can be done with SEGGER_RTT_TerminalOut().

The sequences sent to change the Terminal are interpreted by RTT Viewer. Other applications like a Telnet Client will ignore them.

3.7.10 Using Text Control Codes

RTT allows using Text Control Codes (ANSI escape codes) to configure the display of text.

RTT Viewer supports changing the text color and background color and can erase the Terminal.

These Control Codes are pre-defined in the RTT application and can easily be used in the application.

Example 1:

```
SEGGER_RTT_WriteString(0,
    RTT_CTRL_RESET"Red: "
    RTT_CTRL_TEXT_BRIGHT_RED"This text is red. "
    RTT_CTRL_TEXT_BLACK"
    RTT_CTRL_BG_BRIGHT_RED"This background is red. "
    RTT_CTRL_RESET"Normal text again.");
```

Example 2:

```
SEGGER_RTT_printf(0, "%sTime:%s%s %.7d\n",
    RTT_CTRL_RESET,
    RTT_CTRL_BG_BRIGHT_RED,
    RTT_CTRL_TEXT_BRIGHT_WHITE,
    1111111
);
//
// Clear the terminal.
// The first line will not be shown after this command.
//
SEGGER_RTT_WriteString(0, RTT_CTRL_CLEAR);
SEGGER_RTT_printf(0, "%sTime: %s%s%.7d\n",
    RTT_CTRL_RESET,
    RTT_CTRL_BG_BRIGHT_RED,
    RTT_CTRL_TEXT_BRIGHT_WHITE,
    2222222
);
```

3.8 J-Link SWO Viewer

Free-of-charge utility for J-Link. Displays the terminal output of the target using the SWO pin. The stimulus port(s) from which SWO data is received can be chosen by using the port checkboxes 0 to 31. Can be used in parallel with a debugger or stand-alone. This is especially useful when using debuggers which do not come with built-in support for SWO such as most GDB / GDB+Eclipse based debug environments.

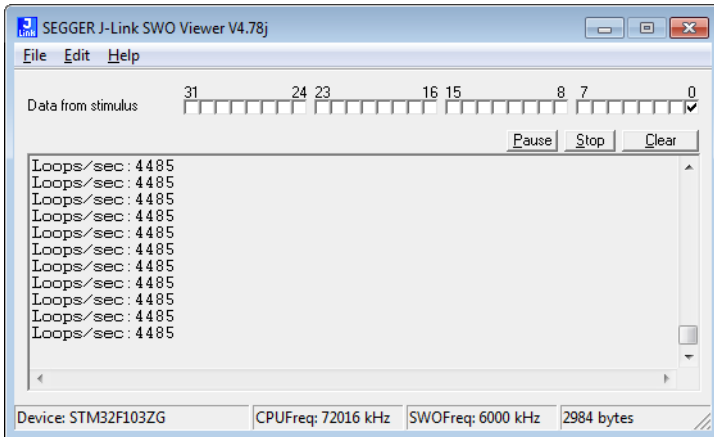

3.8.0.1 J-Link SWO Viewer CL

Command line-only version of SWO Viewer. All commands available for J-Link SWO Viewer can be used with J-Link SWO Viewer CL. Similar to the GUI Version, J-Link SWO Viewer CL asks for a device name or CPU clock speed at startup to be able to calculate the correct SWO speed or to connect to a running J-Link GDB Server

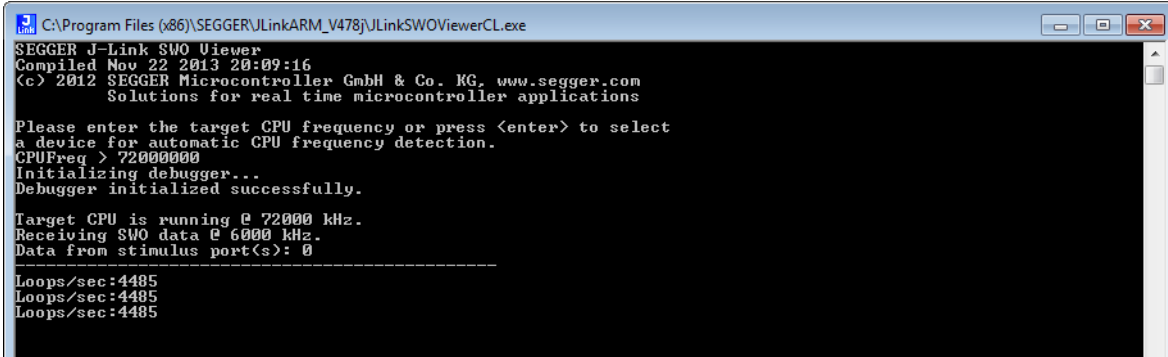

Using the syntax given below ([List of available command line options](#)), you can directly start J-Link SWO Viewer CL with parameters.

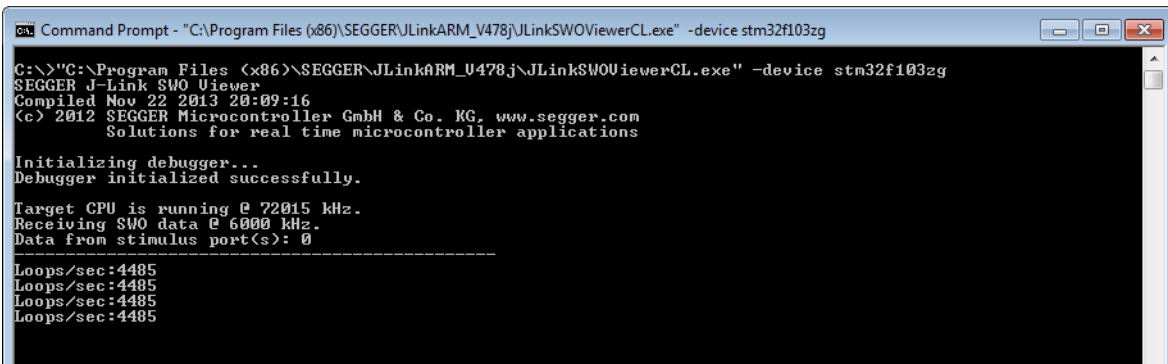

3.8.1 Usage

J-Link SWO Viewer is available via the start menu.

It asks for a device name or CPU clock speed at startup to be able to calculate the correct SWO speed or to connect to a running J-Link GDB Server.

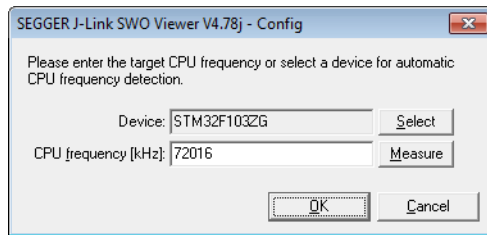

When running in normal mode J-Link SWO Viewer automatically performs the necessary initialization to enable SWO output on the target, in GDB Server mode the initialization has to be done by the debugger.

3.8.2 List of available command line options

J-Link SWO Viewer can also be controlled from the command line if used in a automated test environment etc.

When passing all necessary information to the utility via command line, the configuration dialog at startup is suppressed. Minimum information needed by J-Link SWO Viewer is the device name (to enable CPU frequency auto detection) or the CPU clock speed.

The table below lists the commands accepted by the J-Link SWO Viewer.

Command	Description
<code>cpufreq</code>	Select the CPU frequency.
<code>device</code>	Select the target device.
<code>itmmask</code>	Selects a set of itm stimulus ports which should be used to listen to.
<code>itmport</code>	Selects a itm stimulus port which should be used to listen to.
<code>outputfile</code>	Print the output of SWO Viewer to the selected file.
<code>settingsfile</code>	Specify a J-Link settings file.
<code>swofreq</code>	Select the CPU frequency.

Table 3.16: Available command line options

3.8.2.1 cpufreq

Defines the speed in Hz the CPU is running at. If the CPU is for example running at 96 MHz, the command line should look as below.

Syntax

```
-cpufreq <CPUFreq>
```

Example

```
-cpufreq 96000000
```

3.8.2.2 device

Select the target device to enable the CPU frequency auto detection of the J-Link DLL. To select a ST STM32F207IG as target device, the command line should look as below.

For a list of all supported device names, please refer to <Ref>

Syntax

```
-device <DeviceID>
```

Example

```
-device STM32F207IG
```

3.8.2.3 itmmask

Defines a set of stimulusports from which SWO data is received and displayed by SWO Viewer.

If itmmask is given, itmport will be ignored.

Syntax

```
-itmmask <Mask>
```

Example

Listen on ports 0 and 2

```
-itmmask 0x5
```

3.8.2.4 itmport

Defines the stimulus port from which SWO data is received and displayed by the SWO Viewer. Default is stimulus port 0. The command line should look as below.

Syntax

```
-itmport <ITMPortIndex>
```

Example

```
-itmport 0
```

3.8.2.5 outputfile

Define a file to which the output of SWO Viewer is printed.

Syntax

```
-outputfile <PathToFile>
```

Example

```
-outputfile "C:\Temp\Output.log"
```

3.8.2.6 settingsfile

Select a J-Link settings file to use for the target device.

Syntax

```
-settingsfile <PathToFile>
```

Example

```
-settingsfile "C:\Temp\Settings.jlink"
```

3.8.2.7 swofreq

Define the SWO frequency that shall be used by J-Link SWO Viewer for sampling SWO data.

Usually not necessary to define since optimal SWO speed is calculated automatically based on the CPU frequency and the capabilities of the connected J-Link.

Syntax

```
-swofreq <SWOFreq>
```

Example

```
-swofreq 6000
```

3.8.3 Configure SWO output after device reset

In some situations it might happen that the target application is reset and it is desired to log the SWO output of the target after reset during the booting process. For such situations, the target application itself needs to initialize the CPU for SWO output, since the SWO Viewer is not restarted but continuously running.

Example code for enabling SWO out of the target application

```
#define ITM_ENA      (*(volatile unsigned int*)0xE0000E00) // ITM Enable
#define ITM_TPR     (*(volatile unsigned int*)0xE0000E40) // Trace Privilege Register
#define ITM_TCR     (*(volatile unsigned int*)0xE0000E80) // ITM Trace Control Reg.
#define ITM_LSR     (*(volatile unsigned int*)0xE0000FB0) // ITM Lock Status Register
#define DHCSR       (*(volatile unsigned int*)0xE000EDF0) // Debug register
#define DEMCR       (*(volatile unsigned int*)0xE000EDFC) // Debug register
#define TPIU_ACPR   (*(volatile unsigned int*)0xE0040010) // Async Clock          \
// prescaler register
#define TPIU_SPPR   (*(volatile unsigned int*)0xE00400F0) // Selected Pin Protocol  \
// Register
#define DWT_CTRL    (*(volatile unsigned int*)0xE0001000) // DWT Control Register
#define FFCR        (*(volatile unsigned int*)0xE0040304) // Formatter and flush    \
// Control Register

U32 _ITMPort = 0; // The stimulus port from which SWO data is received and displayed.
U32 TargetDiv = 1; // Has to be calculated according to \
// the CPU speed and the output baud rate

static void _EnableSWO() {
    U32 StimulusRegs;
    //
    // Enable access to SWO registers
    //
    DEMCR |= (1 << 24);
    ITM_LSR = 0xC5ACCE55;
    //
    // Initially disable ITM and stimulus port
    // To make sure that nothing is transferred via SWO
    // when changing the SWO prescaler etc.
    //
    StimulusRegs = ITM_ENA;
    StimulusRegs &= ~(1 << _ITMPort);
    ITM_ENA = StimulusRegs; // Disable ITM stimulus port
    ITM_TCR = 0; // Disable ITM
    //
    // Initialize SWO (prescaler, etc.)
    //
    TPIU_SPPR = 0x00000002; // Select NRZ mode
    TPIU_ACPR = TargetDiv - 1; // Example: 72/48 = 1,5 MHz
    ITM_TPR = 0x00000000;
    DWT_CTRL = 0x400003FE;
    FFCR = 0x00000100;
    //
    // Enable ITM and stimulus port
    //
    ITM_TCR = 0x1000D; // Enable ITM
    ITM_ENA = StimulusRegs | (1 << _ITMPort); // Enable ITM stimulus port
}
}
```

3.8.4 Target example code for terminal output

```
/*
 * SEGGER MICROCONTROLLER GmbH & Co KG
 * Solutions for real time microcontroller applications
 *
 * (c) 2012-2013 SEGGER Microcontroller GmbH & Co KG
 *
 * www.segger.com Support: support@segger.com
 */
```

```

*
*
*****
-----
File      : SWO.c
Purpose  : Simple implementation for output via SWO for Cortex-M processors.
           It can be used with any IDE. This sample implementation ensures that
           output via SWO is enabled in order to gurantee that the application
           does not hang.

-----  END-OF-HEADER  -----
*/

/*****
*
*       Prototypes (to be placed in a header file such as SWO.h)
*/
void SWO_PrintChar  (char c);
void SWO_PrintString(const char *s);

/*****
*
*       Defines for Cortex-M debug unit
*/
#define ITM_STIM_U32 (*(volatile unsigned int*)0xE0000000) // STIM word access
#define ITM_STIM_U8  (*(volatile          char*)0xE0000000) // STIM Byte access
#define ITM_ENA      (*(volatile unsigned int*)0xE0000E00) // ITM Enable Reg.
#define ITM_TCR      (*(volatile unsigned int*)0xE0000E80) // ITM Trace Control Reg.

/*****
*
*       SWO_PrintChar()
*
* Function description
* Checks if SWO is set up. If it is not, return,
* to avoid program hangs if no debugger is connected.
* If it is set up, print a character to the ITM_STIM register
* in order to provide data for SWO.
* Parameters
* c:   The Chacacter to be printed.
* Notes
* Additional checks for device specific registers can be added.
*/
void SWO_PrintChar(char c) {
    //
    // Check if ITM_TCR.ITMENA is set
    //
    if ((ITM_TCR & 1) == 0) {
        return;
    }
    //
    // Check if stimulus port is enabled
    //
    if ((ITM_ENA & 1) == 0) {
        return;
    }
    //
    // Wait until STIMx is ready,
    // then send data
    //
    while ((ITM_STIM_U8 & 1) == 0);
    ITM_STIM_U8 = c;
}

```

```
/******  
*  
*      SWO_PrintString()  
*  
* Function description  
*   Print a string via SWO.  
*  
*/  
void SWO_PrintString(const char *s) {  
    //  
    // Print out character per character  
    //  
    while (*s) {  
        SWO_PrintChar(*s++);  
    }  
}
```

3.9 SWO Analyzer

SWO Analyzer (`SWOAnalyzer.exe`) is a tool that analyzes SWO output. Status and summary of the analysis are output to standard out, the details of the analysis are stored in a file.

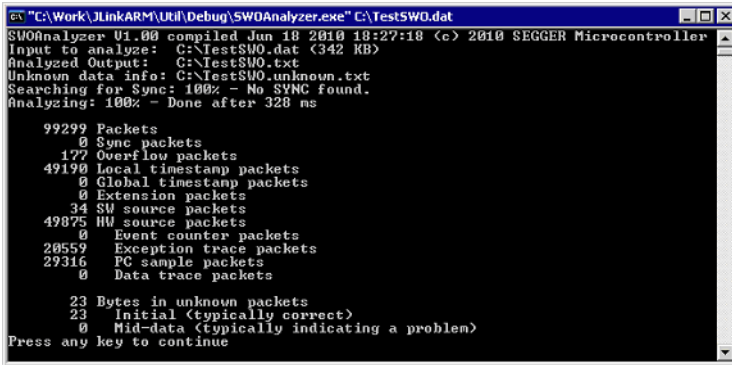

```

C:\Work\JLinkARM\Util\Debug\SWOAnalyzer.exe C:\TestSWO.dat
SWOAnalyzer V1.00 compiled Jun 18 2010 18:27:18 (c) 2010 SEGGER Microcontroller
Input to analyze: C:\TestSWO.dat (342 KB)
Analyzed Output: C:\TestSWO.txt
Unknown data info: C:\TestSWO.unknown.txt
Searching for Sync: 100% - No SYNC found.
Analyzing: 100% - Done after 328 ms

99299 Packets
  0 Sync packets
 177 Overflow packets
49190 Local timestamp packets
  0 Global timestamp packets
  0 Extension packets
 34 SU source packets
49875 HU source packets
  0 Event counter packets
20559 Exception trace packets
29316 PC sample packets
  0 Data trace packets

23 Bytes in unknown packets
23 Initial (typically correct)
  0 Mid-data (typically indicating a problem)
Press any key to continue
  
```

Usage

```
SWOAnalyzer.exe <SWOfile>
```

This can be achieved by simply dragging the SWO output file created by the J-Link DLL onto the executable.

Creating an SWO output file

In order to create the SWO output file, which is the input file for the SWO Analyzer, the J-Link config file needs to be modified.

It should contain the following lines:

```
[SWO]
```

```
SWOLogFile="C:\TestSWO.dat"
```

3.10 JTAGLoad (Command line tool)

JTAGLoad is a tool that can be used to open and execute an svf (Serial vector format) file for JTAG boundary scan tests. The data in the file will be sent to the target via J-Link / J-Trace.

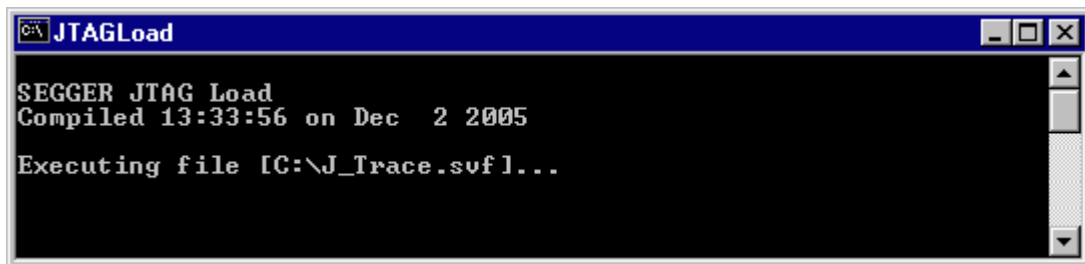

SVF is a standard format for boundary scan vectors to be used with different tools and targets. SVF files contain human-readable ASCII SVF statements consisting of an SVF command, the data to be sent, the expected response, a mask for the response or additional information.

JTAGLoad supports following SVF commands:

- ENDDR
- ENDIR
- FREQUENCY
- HDR
- HIR
- PIOMAP
- PIO
- RUNTEST
- SDR
- SIR
- STATE
- TDR
- TIR

A simple SVF file to read the JTAG ID of the target can look like following:

```
! Set JTAG frequency
FREQUENCY 12000000HZ;
! Configure scan chain
! For a single device in chain, header and trailer data on DR and IR are 0
! Set TAP to IDLE state
STATE IDLE;
! Configure end state of DR and IR after scan operations
ENDDR IDLE;
ENDIR IDLE;
! Start of test
! 32 bit scan on DR, In: 32 0 bits, Expected out: Device ID (0x0BA00477)
SDR 32 TDI (0) TDO (0BA00477) MASK (0FFFFFFF);
! Set TAP to IDLE state
STATE IDLE;
! End of test
```

SVD files allow even more complex tasks, basically everything which is possible via JTAG and the devices in the scan chain, like configuring an FPGA or loading data into memory.

3.11 J-Link RDI (Remote Debug Interface)

The J-Link RDI software is a remote debug interface for J-Link. It makes it possible to use J-Link with any RDI compliant debugger. The main part of the software is an RDI-compliant DLL, which needs to be selected in the debugger. There are two additional features available which build on the RDI software foundation. Each additional feature requires an RDI license in addition to its own license. Evaluation licenses are available free of charge. For further information go to our website or contact us directly.

Note: The RDI software (as well as flash breakpoints and flash downloads) do not require a license if the target device is an LPC2xxx. In this case the software verifies that the target device is actually an LPC 2xxx and have a device-based license.

3.11.1 Flash download and flash breakpoints

Flash download and flash breakpoints are supported by J-Link RDI. For more information about flash download and flash breakpoints, please refer to *J-Link RDI User's Guide (UM08004)*, chapter *Flash download* and chapter *Breakpoints in flash memory*.

3.12 Processor specific tools

The J-Link software and documentation package includes some tools which support processor specific functionalities, like unlocking a device.

3.12.1 J-Link STR91x Commander (Command line tool)

J-Link STR91x Commander (`JLinkSTR91x.exe`) is a tool that can be used to configure STR91x cores. It permits some STR9 specific commands like:

- Set the configuration register to boot from bank 0 or 1.
- Erase flash sectors.
- Read and write the OTP sector of the flash.
- Write-protect single flash sectors by setting the sector protection bits.
- Prevent flash from communicate via JTAG by setting the security bit.

All of the actions performed by the commands, excluding writing the OTP sector and erasing the flash, can be undone. This tool can be used to erase the flash of the controller even if a program is in flash which causes the CPU core to stall.

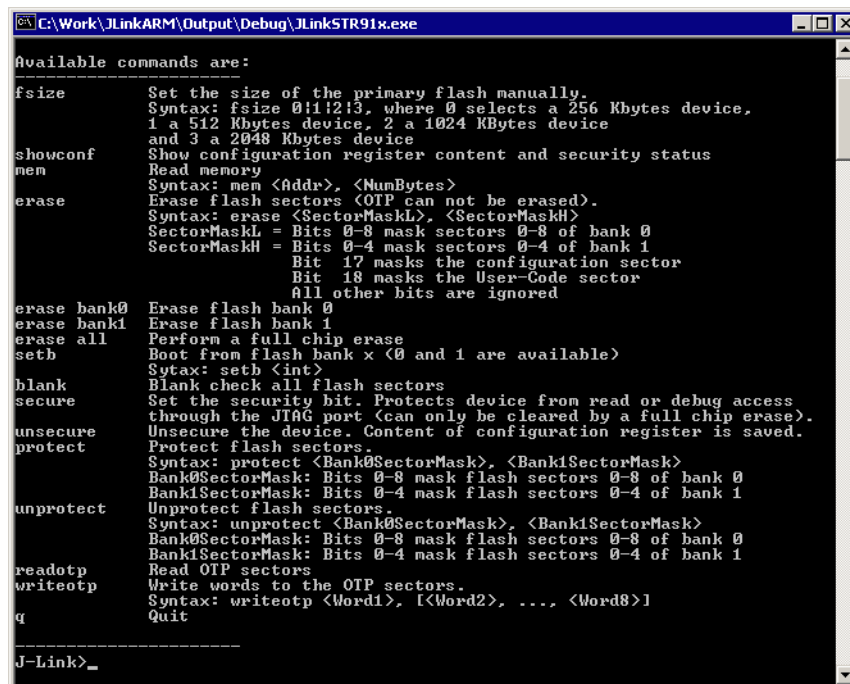

```

C:\Work\JLinkARM\Output\Debug\JLinkSTR91x.exe
Available commands are:
-----
fsize      Set the size of the primary flash manually.
           Syntax: fsize 0|1|2|3, where 0 selects a 256 Kbytes device,
           1 a 512 Kbytes device, 2 a 1024 Kbytes device
           and 3 a 2048 Kbytes device
showconf   Show configuration register content and security status
mem        Read memory
           Syntax: mem <Addr>, <NumBytes>
erase      Erase flash sectors (OTP can not be erased).
           Syntax: erase <SectorMaskL>, <SectorMaskH>
           SectorMaskL = Bits 0-8 mask sectors 0-8 of bank 0
           SectorMaskH = Bits 0-4 mask sectors 0-4 of bank 1
           Bit 17 masks the configuration sector
           Bit 18 masks the User-Code sector
           All other bits are ignored
erase bank0 Erase flash bank 0
erase bank1 Erase flash bank 1
erase all   Perform a full chip erase
setb        Boot from flash bank x (<0 and 1 are available>)
           Syntax: setb <int>
blank      Blank check all flash sectors
secure     Set the security bit. Protects device from read or debug access
           through the JTAG port (can only be cleared by a full chip erase).
unsecure   Unsecure the device. Content of configuration register is saved.
protect    Protect flash sectors.
           Syntax: protect <Bank0SectorMask>, <Bank1SectorMask>
           Bank0SectorMask: Bits 0-8 mask flash sectors 0-8 of bank 0
           Bank1SectorMask: Bits 0-4 mask flash sectors 0-4 of bank 1
unprotect  Unprotect flash sectors.
           Syntax: unprotect <Bank0SectorMask>, <Bank1SectorMask>
           Bank0SectorMask: Bits 0-8 mask flash sectors 0-8 of bank 0
           Bank1SectorMask: Bits 0-4 mask flash sectors 0-4 of bank 1
readotp    Read OTP sectors
writeotp   Write words to the OTP sectors.
           Syntax: writeotp <Word1>, [<Word2>, ..., <Word8>]
q          Quit

-----
J-Link>_
  
```

When starting the STR91x commander, a command sequence will be performed which brings MCU into Turbo Mode.

"While enabling the Turbo Mode, a dedicated test mode signal is set and controls the GPIOs in output. The IOs are maintained in this state until a next JTAG instruction is sent." (ST Microelectronics)

Enabling Turbo Mode is necessary to guarantee proper function of all commands in the STR91x Commander.

3.12.1.1 Command line options

J-Link STR91x Commander can be started with different command line options. In the following, the command line options which are available for J-Link STR91x Commander are explained.

-CommandFile

Selects a command file and starts J-Link STR91x Commander in batch mode. The batch mode of J-Link Commander is similar to the execution of a batch file. The command file is parsed line by line and one command is executed at a time.

Syntax

```
-CommanderScript <CommandFilePath>
```

Example

See *Using command files* on page 103

-DRPre, -DRPost, -IRPre and -IRPost (Scan-Chain Configuration)

STR91x allows to configure a specific scan-chain via command-line. To use this feature four command line options have to be specified in order to allow a proper connection to the proper device. In case of passing an incomplete configuration, the utility tries to auto-detect.

Syntax

```
-DRPre <DRPre>
-DRPost <DRPost>
-IRPre <IRPre>
-IRPost <IRPost>
```

Example

```
JLink.exe -DRPre 1 -DRPost 4 -IRPre 16 -IRPost 20
```

-IP

Selects IP as host interface to connect to J-Link. Default host interface is USB.

Syntax

```
-IP <IPAddr>
```

Example

```
JLinkSTR91x.exe -IP 192.168.1.17
```

Additional information

To select from a list of all available emulators on Ethernet, please use * as <IPAddr>.

-SelectEmuBySN

Connect to a J-Link with a specific serial number via USB. Useful if multiple J-Links are connected to the same PC and multiple instances of J-Link STR91x Commander shall run and each connects to another J-Link.

Syntax

```
-SelectEmuBySN <SerialNo>
```

Example

```
JLinkSTR91x.exe -SelectEmuBySN 580011111
```

3.12.2 J-Link STM32 Unlock (Command line tool)

J-Link STM32 Unlock (`JLinkSTM32.exe`) is a free command line tool which can be used to disable the hardware watchdog of STM32 devices which can be activated by programming the option bytes. Moreover the J-Link STM32 Commander unsecures a read-protected STM32 device by re-programming the option bytes.

Note: Unprotecting a secured device or will cause a mass erase of the flash memory.

```

C:\Program Files (x86)\SEGGER\JLink_V498e\JLinkSTM32.exe
SEGGER J-Link Unlock tool for STM32 devices
Compiled May 5 2015 11:01:50
SEGGER Microcontroller GmbH & Co. KG, www.segger.com
Solutions for real time microcontroller applications

[0] Exit
[1] STM32F0xxxx
[2] STM32F1xxxx
[3] STM32F2xxxx
[4] STM32F3xxxx
[5] STM32F4xxxx
[6] STM32L1xxxx

Please select the correct device family: 3
Connecting to J-Link via USB...O.K.
Using SWD as target interface.
Target interface speed: 1000 kHz.
Utarget = 3.285U
Reset target...O.K.
Reset option bytes (may take app. 20 seconds)...O.K.
Press any key to exit.

```

3.12.2.1 Command Line Options

The J-Link STM32 Unlock Utility can be started with different command line options for test and automation purposes. In the following, the available command line options are explained.

-IP

Selects IP as host interface to connect to J-Link. Default host interface is USB.

Syntax

```
-IP <IPAddr>
```

Example

```
JLinkSTM32.exe -IP 192.168.1.17
```

Additional information

To select from a list of all available emulators on Ethernet, please use * as <IPAddr>.

-SelectEmuBySN

Connect to a J-Link with a specific serial number via USB. Useful if multiple J-Links are connected to the same PC.

Syntax

```
-SelectEmuBySN <SerialNo>
```

Example

```
JLinkSTM32.exe -SelectEmuBySN 580011111
```

-Speed

Starts J-Link STM32 Unlock Utility with a given initial speed. Available parameters are "adaptive", "auto" or a freely selectable integer value in kHz. It is recommended to use either a fixed speed or, if it is available on the target, adaptive speeds. Default interface speed is 1000 kHz.

Syntax

```
-Speed <Speed_kHz>
```

-SetPowerTarget

The connected debug probe will power the target via pin 19 of the debug connector.

Syntax

```
-SetPowerTarget <Mode>
```

Example

```
JLinkSTM32.exe -SetPowerTarget 1 // Target power will be set
```

-SetDeviceFamily

This command allows to specify a device family, so that no user input is required to start the unlocking process.

Syntax

```
-SetDeviceFamily <Parameter>
```

Parameter

There are two different options to specify the device family to be used:

- a) Pass the list index from the list which shows all supported families on start up
- b) Pass the defined device name

ListIndex	Name
1	STM32F0xxxx
2	STM32F1xxxx
3	STM32F2xxxx
4	STM32F3xxxx
5	STM32F4xxxx
6	STM32L1xxxx

Table 3.17: Available Parameter for -SetDeviceFamily

Example

```
JLinkSTM32.exe -SetDeviceFamily 6 // Selects STM32L1 series
JLinkSTM32.exe -SetDeviceFamily STM32L1xxxx // Selects STM32L1 series
```

-Exit

In general, the J-Link STM32 utility waits at the end of the unlock process for any user input before application closes. This option allows to skip this step, so that the utility closes automatically.

Syntax

```
-Exit <Mode>
```

Example

```
JLinkSTM32.exe -Exit 1 // J-Link STM32 utility closes automatically
```

3.13 J-Link Software Developer Kit (SDK)

The J-Link Software Developer Kit is needed if you want to write your own program with J-Link / J-Trace. The J-Link DLL is a standard Windows DLL typically used from C programs (Visual Basic or Delphi projects are also possible). It makes the entire functionality of J-Link / J-Trace available through its exported functions, such as halting/stepping the CPU core, reading/writing CPU and ICE registers and reading/writing memory. Therefore it can be used in any kind of application accessing a CPU core. The standard DLL does not have API functions for flash programming. However, the functionality offered can be used to program flash. In this case, a flash loader is required. The table below lists some of the included files and their respective purpose.

The J-Link SDK requires an additional license and is available upon request from www.segger.com.

Chapter 4

Setup

This chapter describes the setup procedure required in order to work with J-Link / J-Trace. Primarily this includes the installation of the J-Link software and documentation package, which also includes a kernel mode J-Link USB driver in your host system.

4.1 Installing the J-Link software and documentation pack

J-Link is shipped with a bundle of applications, corresponding manuals and some example projects and the kernel mode J-Link USB driver. Some of the applications require an additional license, free trial licenses are available upon request from www.segger.com.

Refer to chapter *J-Link software and documentation package* on page 81 for an overview of the J-Link software and documentation pack.

4.1.1 Setup procedure

To install the J-Link software and documentation pack, follow this procedure:

Note: We recommend to check if a newer version of the J-Link software and documentation pack is available for download before starting the installation. Check therefore the J-Link related download section of our website:

http://www.segger.com/download_jlink.html

1. Before you plug your J-Link / J-Trace into your computer's USB port, extract the setup tool `Setup_JLinkARM_V<VersionNumber>.zip`. The setup wizard will install the software and documentation pack that also includes the certified J-Link USB driver. Start the setup by double clicking `Setup_JLinkARM_V<VersionNumber>.exe`. The **license Agreement** dialog box will be opened. Accept the terms with the **Yes** button.

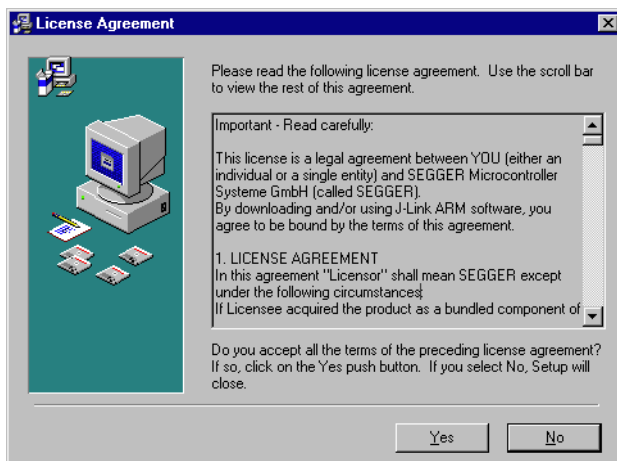

- The **Welcome** dialog box is opened. Click **Next >** to open the **Choose Destination Location** dialog box.

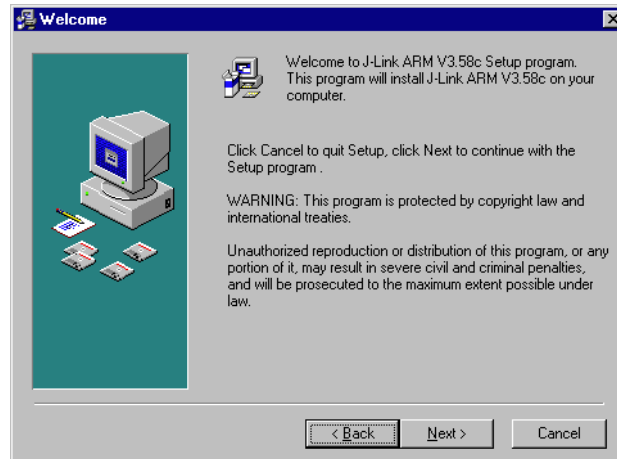

- Accept the default installation path `C:\Program Files\SEGGER\JLinkARM_V<VersionNumber>` or choose an alternative location. Confirm your choice with the **Next >** button.

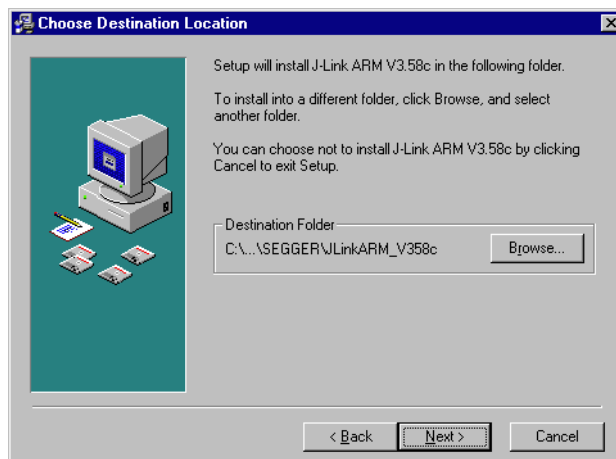

- The **Choose options** dialog is opened. The **Install J-Link Serial Port Driver** installs the driver for J-Links with CDC functionality. It is not preselected since J-Links without CDC functionality do not need this driver. The **Create entry in start menu** creates an entry in start menu. It is preselected. The **Add shortcuts to desktop** option can be selected in order to create a shortcut on the desktop. Accept or deselect the options and confirm the selection with the **Next >** button.

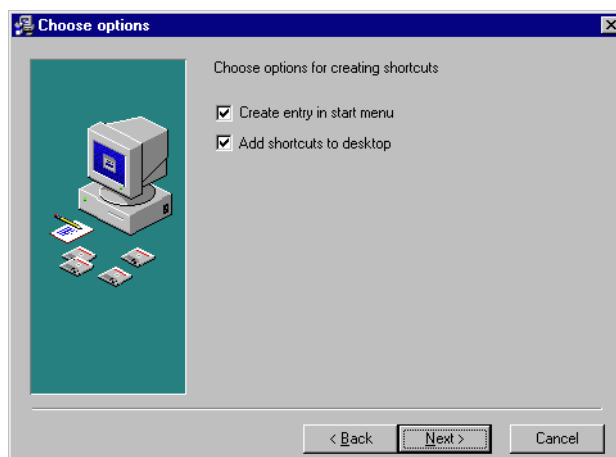

5. The installation process will start.

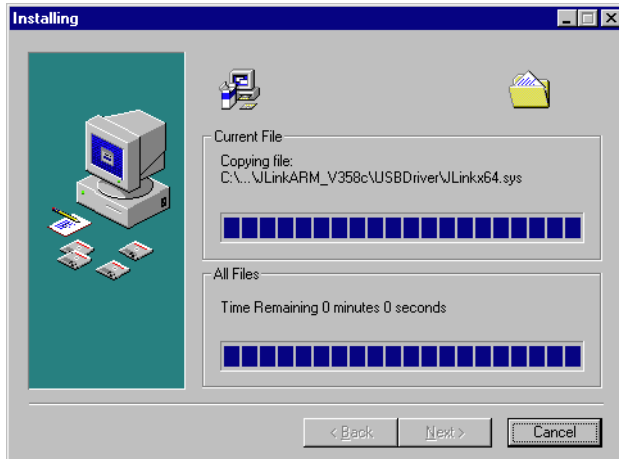

6. The J-Link DLL Updater pops up, which allows you to update the DLL of an installed IDE to the DLL version which is included in the installer. For further information about the J-Link DLL updater, please refer to *J-Link DLL updater* on page 181.

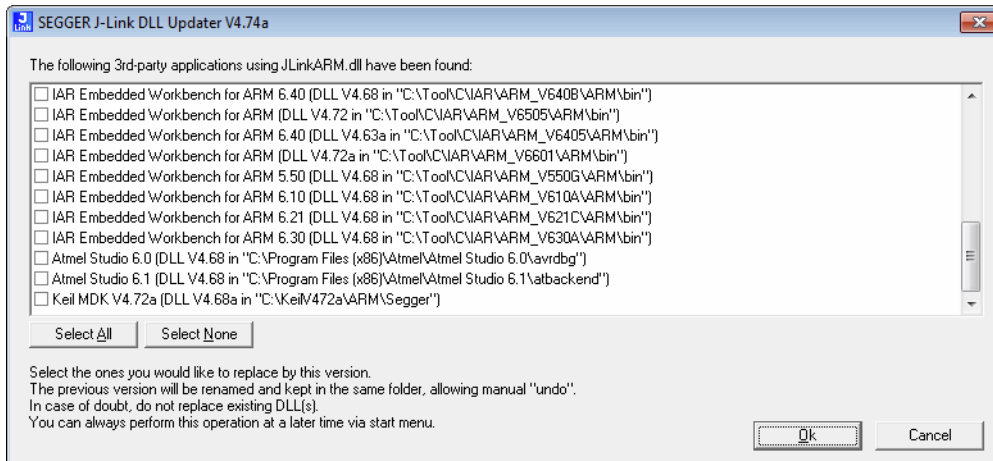

7. The **Installation Complete** dialog box appears after the copy process. Close the installation wizard with the **Finish >** button. The J-Link software and documentation pack is successfully installed on your PC.

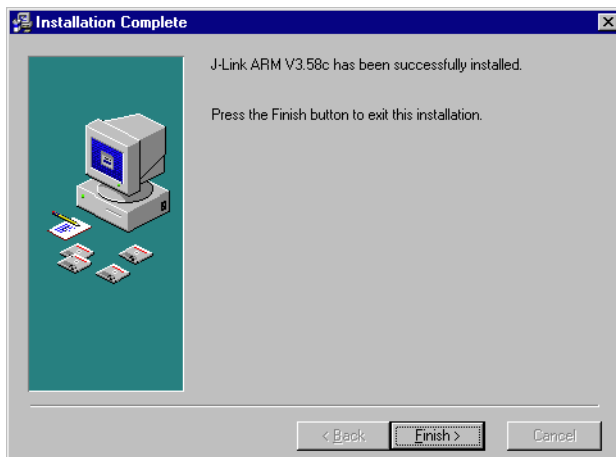

8. Connect your J-Link via USB with your PC. The J-Link will be identified and after a short period the J-Link LED stops rapidly flashing and stays on permanently.

4.2 Setting up the USB interface

After installing the J-Link software and documentation package it should not be necessary to perform any additional setup sequences in order to configure the USB interface of J-Link.

4.2.1 Verifying correct driver installation

To verify the correct installation of the driver, disconnect and reconnect J-Link / J-Trace to the USB port. During the enumeration process which takes about 2 seconds, the LED on J-Link / J-Trace is flashing. After successful enumeration, the LED stays on permanently.

Start the provided sample application `JLink.exe`, which should display the compilation time of the J-Link firmware, the serial number, a target voltage of 0.000V, a complementary error message, which says that the supply voltage is too low if no target is connected to J-Link / J-Trace, and the speed selection. The screenshot below shows an example.

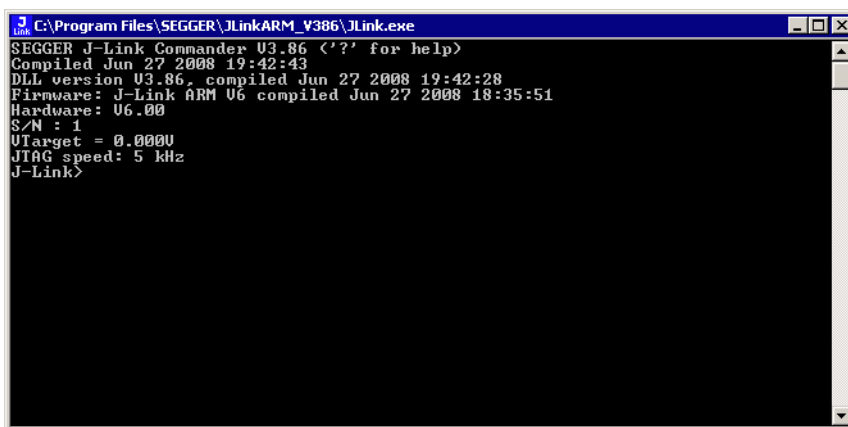

```

C:\Program Files\SEGGER\JLinkARM_V386\JLink.exe
SEGGER J-Link Commander V3.86 ('?' for help)
Compiled Jun 27 2008 19:42:43
DLL version V3.86, compiled Jun 27 2008 19:42:28
Firmware: J-Link ARM V6 compiled Jun 27 2008 18:35:51
Hardware: V6.00
S/N : 1
VTarget = 0.0000
JTAG speed: 5 kHz
J-Link>
  
```

In addition you can verify the driver installation by consulting the Windows device manager. If the driver is installed and your J-Link / J-Trace is connected to your computer, the device manager should list the J-Link USB driver as a node below "Universal Serial Bus controllers" as shown in the following screenshot:

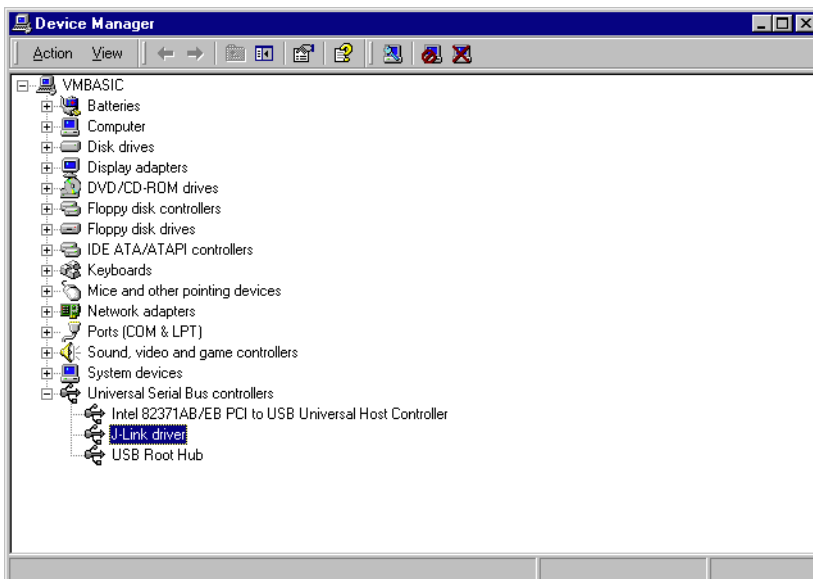

Right-click on the driver to open a context menu which contains the command **Properties**. If you select this command, a **J-Link driver Properties** dialog box is opened and should report: **This device is working properly**.

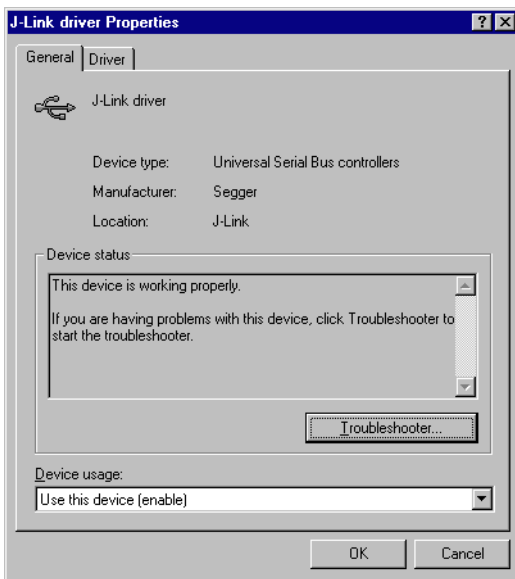

If you experience problems, refer to the chapter *Support and FAQs* on page 465 for help. You can select the **Driver** tab for detailed information about driver provider, version, date and digital signer.



4.2.2 Uninstalling the J-Link USB driver

If J-Link / J-Trace is not properly recognized by Windows and therefore does not enumerate, it makes sense to uninstall the J-Link USB driver.

This might be the case when:

- The LED on the J-Link / J-Trace is rapidly flashing.
- The J-Link / J-Trace is recognized as **Unknown Device** by Windows.

To have a clean system and help Windows to reinstall the J-Link driver, follow this procedure:

1. Disconnect J-Link / J-Trace from your PC.
2. Open the **Add/Remove Programs** dialog (Start > Settings > Control Panel > Add/Remove Programs) and select **Windows Driver Package - Segger**

(jlink) USB and click the **Change/Remove** button.

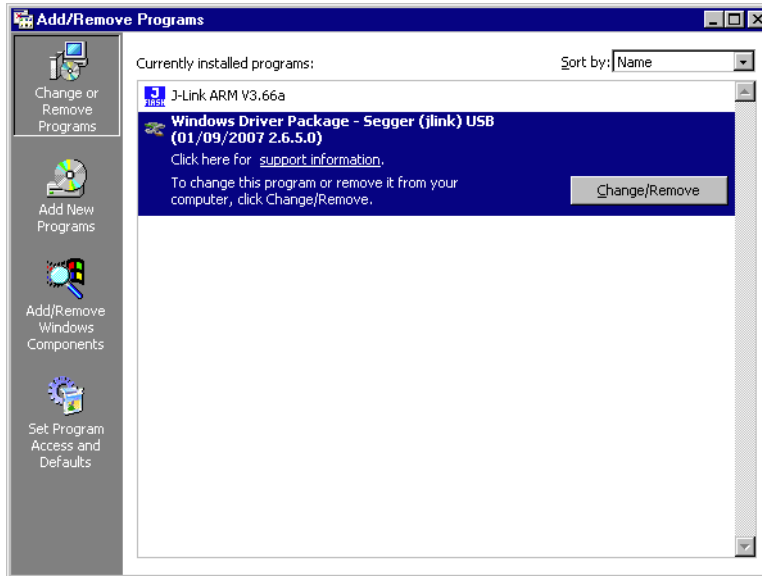

3. Confirm the uninstallation process.

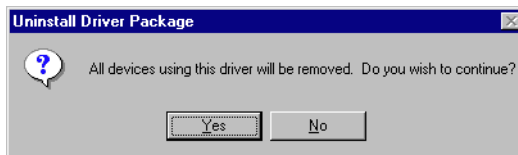

4.3 Setting up the IP interface

Some emulators of the J-Link family have (or future members will have) an additional Ethernet interface, to communicate with the host system. These emulators will also come with a built-in web server which allows configuration of the emulator via web interface. In addition to that, you can set a default gateway for the emulator which allows using it even in large intranets. For simplicity the setup process of J-Link Pro (referred to as J-Link) is described in this section.

4.3.1 Configuring J-Link using J-Link Configurator

The J-Link software and documentation package comes with a free GUI-based utility called J-Link Configurator which auto-detects all J-Links that are connected to the host PC via USB & Ethernet. The J-Link Configurator allows the user to setup the IP interface of J-Link. For more information about how to use the J-Link Configurator, please refer to *J-Link Configurator* on page 177.

4.3.2 Configuring J-Link using the webinterface

All emulators of the J-Link family which come with an Ethernet interface also come with a built-in web server, which provides a web interface for configuration. This enables the user to configure J-Link without additional tools, just with a simple web browser. The **Home** page of the web interface shows the serial number, the current IP address and the MAC address of the J-Link.

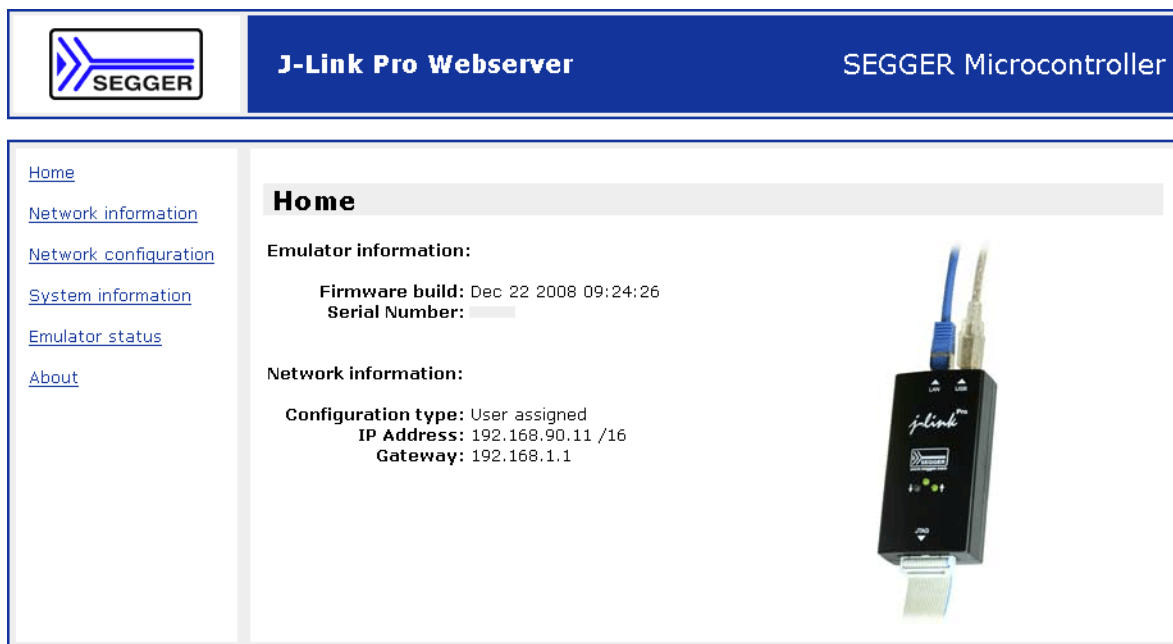

The screenshot displays the J-Link Pro Webserver interface. At the top, there is a blue header bar with the SEGGER logo on the left, the text "J-Link Pro Webserver" in the center, and "SEGGER Microcontroller" on the right. Below the header, the main content area is divided into a left sidebar and a main panel. The sidebar contains a list of navigation links: Home, Network information, Network configuration, System information, Emulator status, and About. The main panel features a "Home" title and the following information:

- Emulator information:**
 - Firmware build: Dec 22 2008 09:24:26
 - Serial Number: [REDACTED]
- Network information:**
 - Configuration type: User assigned
 - IP Address: 192.168.90.11 /16
 - Gateway: 192.168.1.1

To the right of the text, there is a photograph of a J-Link Pro emulator device, which is a small black rectangular unit with a blue Ethernet cable and a gold USB cable plugged into it. The device has the "j-link" logo and several status LEDs on its front panel.

The **Network configuration** page allows configuration of network related settings (IP address, subnet mask, default gateway) of J-Link. The user can choose between **automatic** IP assignment (settings are provided by a DHCP server in the network) and **manual** IP assignment by selecting the appropriate radio button.

	J-Link Pro Webserver	SEGGER Microcontroller
---	-----------------------------	------------------------

Home	<h3>Network configuration</h3> <p><input type="radio"/> Automatic <input checked="" type="radio"/> Manual</p> <p><input checked="" type="checkbox"/> DHCP</p> <p>IP address: <input type="text" value="192"/> . <input type="text" value="168"/> . <input type="text" value="90"/> . <input type="text" value="11"/></p> <p>Subnet mask: <input type="text" value="255"/> . <input type="text" value="255"/> . <input type="text" value="0"/> . <input type="text" value="0"/></p> <p>Gateway: <input type="text" value="192"/> . <input type="text" value="168"/> . <input type="text" value="1"/> . <input type="text" value="1"/></p> <p><input type="button" value="Change"/></p>
Network information	
Network configuration	
System information	
Emulator status	
About	

4.4 FAQs

Q: How can I use J-Link with GDB and Ethernet?

A: You have to use the J-Link GDB Server in order to connect to J-Link via GDB and Ethernet.

4.5 J-Link Configurator

Normally, no configuration is required, especially when using J-Link via USB. For special cases like having multiple older J-Links connected to the same host PC in parallel, they need to be re-configured to be identified by their real serial number when enumerating on the host PC. This is the default identification method for current J-Links (J-Link with hardware version 8 or later). For re-configuration of old J-Links or for configuration of the IP settings (use DHCP, IP address, subnet mask, ...) of a J-Link supporting the Ethernet interface, SEGGER provides a GUI-based tool, called J-Link Configurator. The J-Link Configurator is part of the J-Link software and documentation package and can be used free of charge.

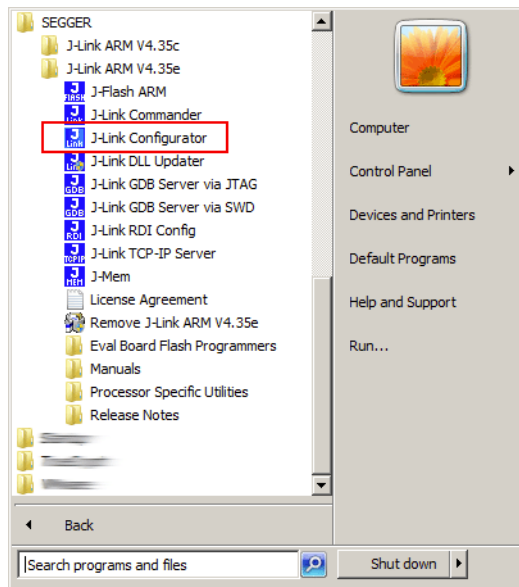

4.5.1 Configure J-Links using the J-Link Configurator

A J-Link can be easily configured by selecting the appropriate J-Link from the emulator list and using right click -> Configure.

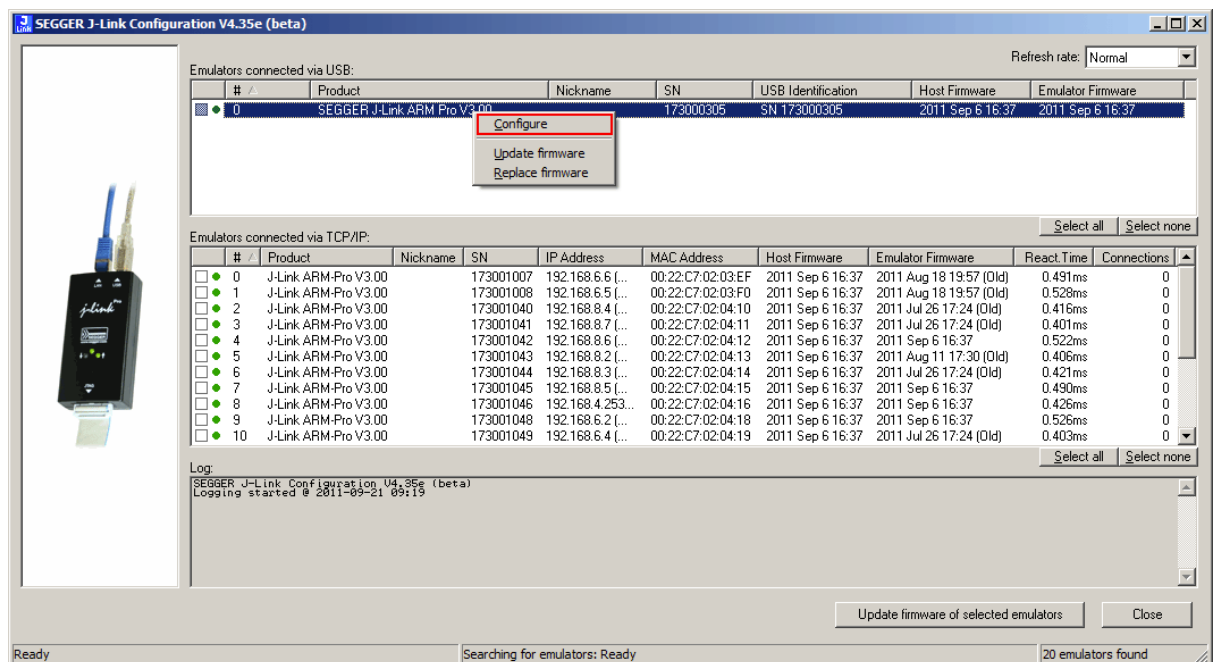

In order to configure an old J-Link, which uses the old USB 0 - 3 USB identification method, to use the new USB identification method (reporting the real serial number) simply select "Real SN" as USB identification method and click the OK button. The same dialog also allows configuration of the IP settings of the connected J-Link if it supports the Ethernet interface.

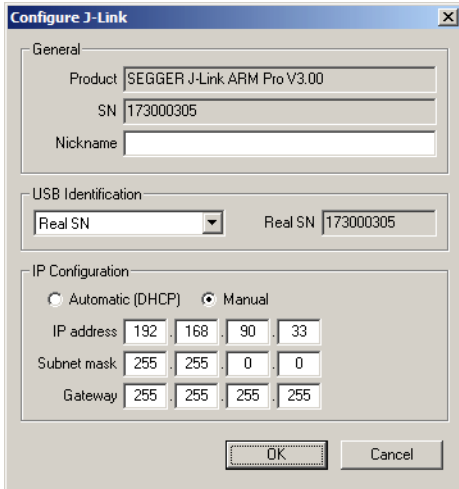

4.6 J-Link USB identification

In general, when using USB, there are two ways in which a J-Link can be identified:

- By serial number
- By USB address

Default configuration of J-Link is: Identification by serial number. Identification via USB address is used for compatibility and not recommended.

Background information

"USB address" really means changing the USB-Product ID (PID).

The following table shows how J-Links enumerate in the different identification modes.

Identification	PID	Serial number
Serial number (default)	0x0101	Serial number is real serial number of the J-Link or user assigned.
USB address 0 (Deprecated)	0x0101	123456
USB address 1 (Deprecated)	0x0102	123456
USB address 2 (Deprecated)	0x0103	123456
USB address 3 (Deprecated)	0x0104	123456

Table 4.1: J-Link enumeration in different identification modes

4.6.1 Connecting to different J-Links connected to the same host PC via USB

In general, when having multiple J-Links connected to the same PC, the J-Link to connect to is explicitly selected by its serial number. Most software/debuggers provide an extra field to type-in the serial number of the J-Link to connect to.

The following screenshot shows the connection dialog of the J-Flash software:

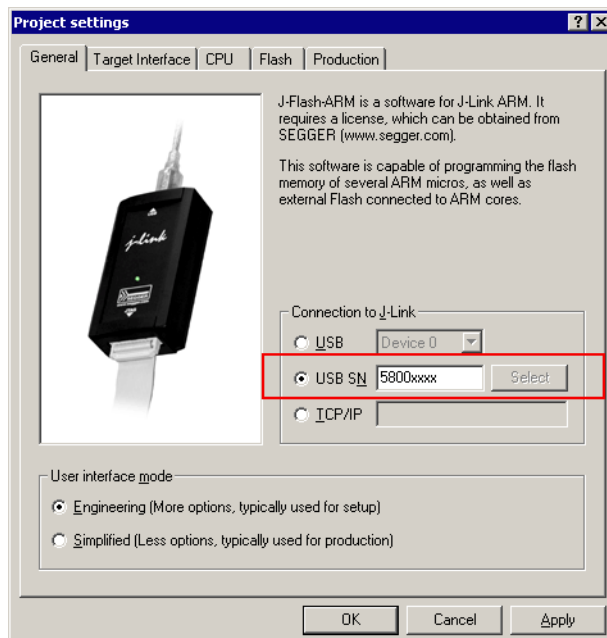

The following screenshot shows the connection dialog of IAR EWARM:

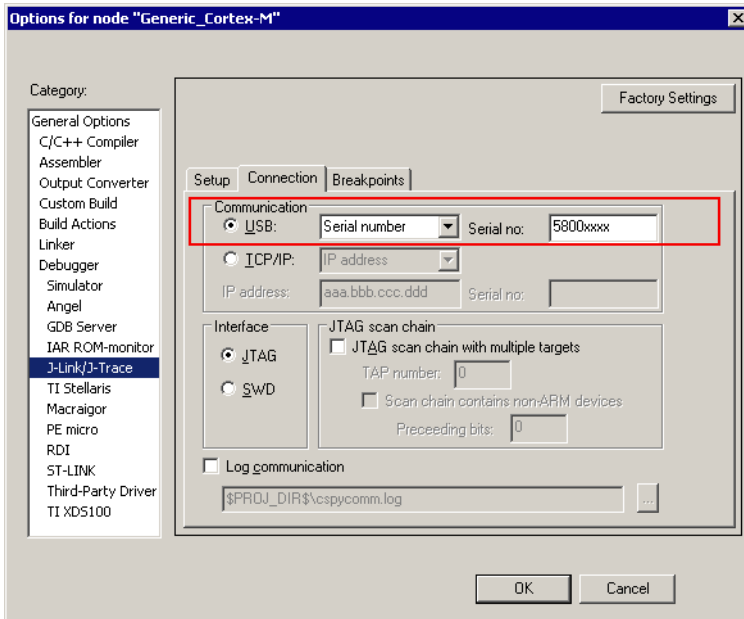

A debugger / software which does not provide such a functionality, the J-Link DLL automatically detects that multiple J-Links are connected to the PC and shows a selection dialog which allows the user to select the appropriate J-Link to connect to.

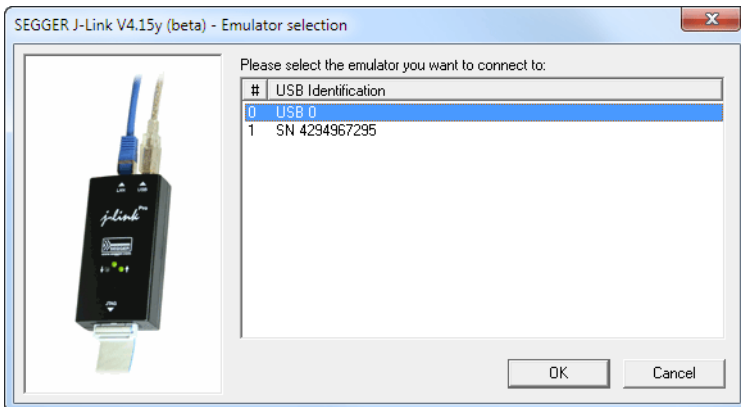

So even in IDEs which do not have an selection option for the J-Link, it is possible to connect to different J-Links.

4.7 Using the J-Link DLL

4.7.1 What is the JLink DLL?

The `J-LinkARM.dll` is a standard Windows DLL typically used from C or C++, but also Visual Basic or Delphi projects. It makes the entire functionality of the J-Link / J-Trace available through the exported functions.

The functionality includes things such as halting/stepping the ARM core, reading/writing CPU and ICE registers and reading/writing memory. Therefore, it can be used in any kind of application accessing a CPU core.

4.7.2 Updating the DLL in third-party programs

The JLink DLL can be used by any debugger that is designed to work with it. Some debuggers are usually shipped with the J-Link DLL already installed. Anyhow it may make sense to replace the included DLL with the latest one available, to take advantage of improvements in the newer version.

4.7.2.1 Updating the J-Link DLL in the IAR Embedded Workbench for ARM (EWARM)

It is recommended to use the J-Link DLL updater to update the J-Link DLL in the IAR Embedded Workbench. The IAR Embedded Workbench IDE is a high-performance integrated development environment with an editor, compiler, linker, debugger. The compiler generates very efficient code and is widely used. It comes with the `J-LinkARM.dll` in the `arm\bin` subdirectory of the installation directory. To update this DLL, you should backup your original DLL and then replace it with the new one.

Typically, the DLL is located in `C:\Program Files\IAR Systems\Embedded Workbench 6.n\arm\bin\`.

After updating the DLL, it is recommended to verify that the new DLL is loaded as described in *Determining which DLL is used by a program* on page 182.

J-Link DLL updater

The J-Link DLL updater is a tool which comes with the J-Link software and allows the user to update the `JLinkARM.dll` in all installations of the IAR Embedded Workbench, in a simple way. The updater is automatically started after the installation of a J-Link software version and asks for updating old DLLs used by IAR. The J-Link DLL updater can also be started manually. Simply enable the checkbox left to the IAR installation which has been found. Click **Ok** in order to update the `JLinkARM.dll` used by the IAR installation.

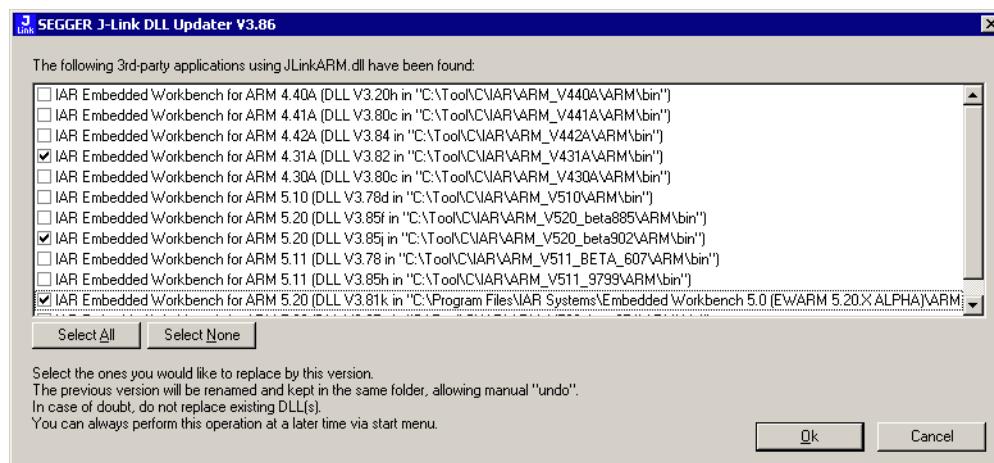

4.7.3 Determining the version of JLink DLL

To determine which version of the JLinkARM.dll you are using, the DLL version can be viewed by right clicking the DLL in explorer and choosing `Properties` from the context menu. Click the `Version` tab to display information about the product version.

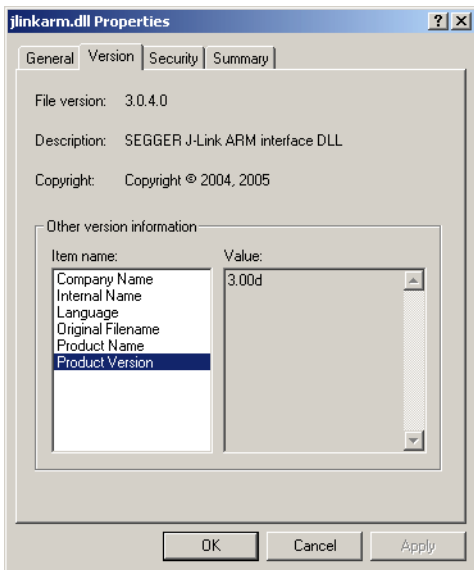

4.7.4 Determining which DLL is used by a program

To verify that the program you are working with is using the DLL you expect it to use, you can investigate which DLLs are loaded by your program with tools like Sysinternals' Process Explorer. It shows you details about the DLLs used by your program, such as manufacturer and version.

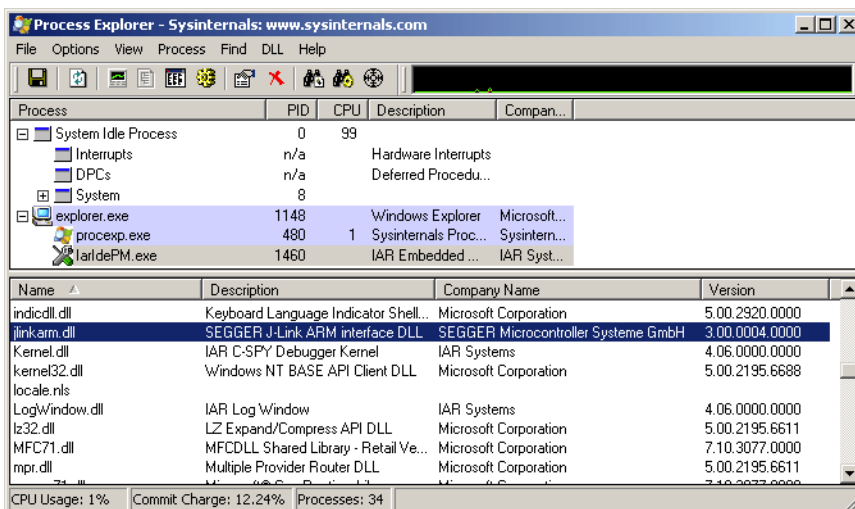

Process Explorer is - at the time of writing - a free utility which can be downloaded from www.sysinternals.com.

4.8 Getting started with J-Link and ARM DS-5

J-Link supports ARM DS-5 Development via the RDDI protocol.

For commercially using J-Link via RDDI in ARM DS-5, an RDI/RDDI license is required. J-Link models which come with an RDI license, can also be used via RDDI. RDDI can be evaluated free of charge.

In order to use J-Link in ARM DS-5 Development Studio, the RDDI DLL in DS-5 needs to be replaced by the SEGGER version of this DLL. The SEGGER version of the RDDI still allows using ARM's DSTREAM in DS-5. After installing the J-Link software and documentation package, the J-Link DLL Updater is started which allows easily updating the RDDI DLL in DS-5. An backup of the original DLL is made automatically.

4.8.1 Replacing the RDDI DLL manually

If J-Link DLL Updater is unable to find a DS-5 installation and does not list it for updating, the RDDI DLL can always be replaced manually. For more information about how to manually update the RDDI DLL, please refer to `$JLINK_INST_DIR$\RDDI\ManualInstallation.txt`.

4.8.2 Using J-Link in DS-5 Development Studio

Please follow the following steps, in order to use J-Link in DS-5, after replacing the RDDI DLL accordingly:

- Connect J-Link and target.
- Open ARM DS-5.
- Open DS-5 Project for target.
- Open **Debug Configurations...**
- Select DS-5 Debugger on the left side.
- Press **New** button.
- In the Connection tab, select The target from the device database, **Bare Metal Debug, Debug via DSTREAM/RVI**.
- Click on the **Browse...** button right to the Text box at the bottom **Connection**.
- In the Dialog select the J-Link which is connected to the target (e.g. **JLinkUSB:174200001**).

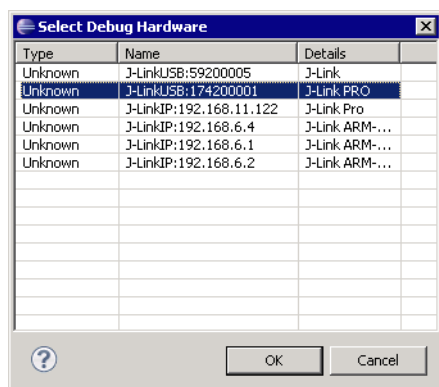

- Click **OK**.
- Add the device name to the connection string (e.g. **JLinkUSB:174200001:Device**

STM32F103ZG).

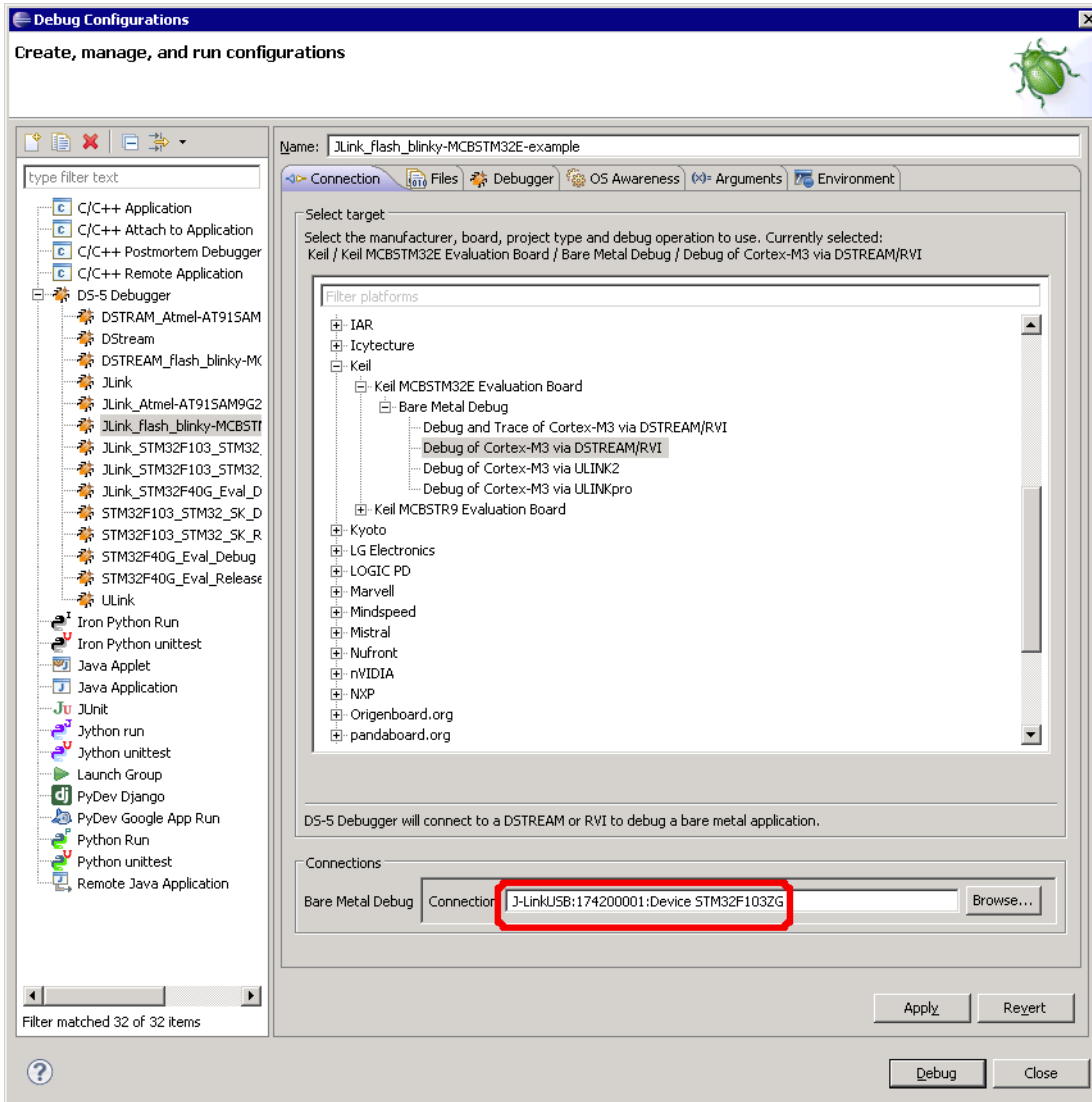

- Click **Apply**.
- In the **Files** tab, select the application to download.
- In the **Debugger** tab, select 'Debug from symbol' and enter main or select **Debug from entry point**.
- Click **Apply**.
- Start a new debug session with the newly created debug configuration.
- Now the debug session should start and downloaded the application to the target.

Chapter 5

Working with J-Link and J-Trace

This chapter describes functionality and how to use J-Link and J-Trace.

5.1 Connecting the target system

5.1.1 Power-on sequence

In general, J-Link / J-Trace should be powered on before connecting it with the target device. That means you should first connect J-Link / J-Trace with the host system via USB and then connect J-Link / J-Trace with the target device via JTAG. Power-on the device after you connected J-Link / J-Trace to it.

5.1.2 Verifying target device connection

If the USB driver is working properly and your J-Link / J-Trace is connected with the host system, you may connect J-Link / J-Trace to your target hardware. Then start `JLink.exe` which should now display the normal J-Link / J-Trace related information and in addition to that it should report that it found a JTAG target and the target's core ID. The screenshot below shows the output of `JLink.exe`. As can be seen, it reports a J-Link with one JTAG device connected.

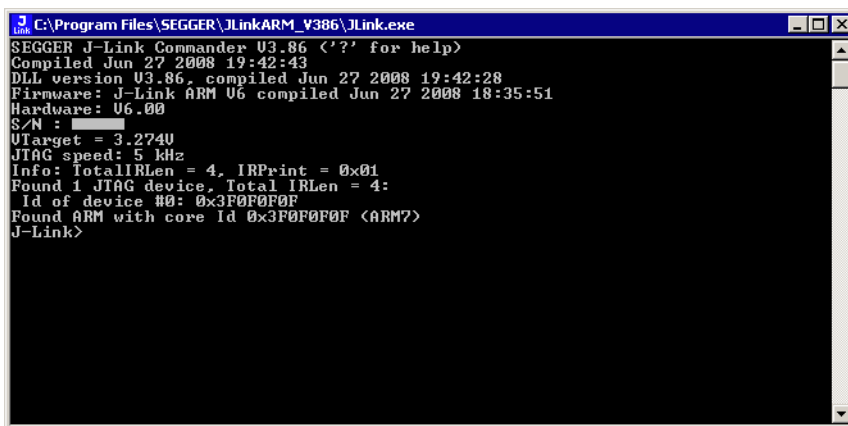

```
C:\Program Files\SEGGER\JLinkARM_V386\JLink.exe
SEGGER J-Link Commander V3.86 ('?' for help)
Compiled Jun 27 2008 19:42:43
DLL version V3.86, compiled Jun 27 2008 19:42:28
Firmware: J-Link ARM U6 compiled Jun 27 2008 18:35:51
Hardware: U6.00
S/N : 
UTarget = 3.2740
JTAG speed: 5 kHz
Info: TotalIRLen = 4, IRPrint = 0x01
Found 1 JTAG device, Total IRLen = 4:
  Id of device #0: 0x3F0F0F0F
Found ARM with core Id 0x3F0F0F0F <ARM7>
J-Link>
```

5.1.3 Problems

If you experience problems with any of the steps described above, read the chapter *Support and FAQs* on page 465 for troubleshooting tips. If you still do not find appropriate help there and your J-Link / J-Trace is an original SEGGER product, you can contact SEGGER support via e-mail. Provide the necessary information about your target processor, board etc. and we will try to solve your problem. A checklist of the required information together with the contact information can be found in chapter *Support and FAQs* on page 465 as well.

5.2 Indicators

J-Link uses indicators (LEDs) to give the user some information about the current status of the connected J-Link. All J-Links feature the main indicator. Some newer J-Links such as the J-Link Pro / Ultra come with additional input/output Indicators. In the following, the meaning of these indicators will be explained.

5.2.1 Main indicator

For J-Links up to V7, the main indicator is single color (Green). J-Link V8 comes with a bi-color indicator (Green & Red LED), which can show multiple colors: green, red and orange.

5.2.1.1 Single color indicator (J-Link V7 and earlier)

Indicator status	Meaning
GREEN, flashing at 10 Hz	Emulator enumerates.
GREEN, flickering	Emulator is in operation. Whenever the emulator is executing a command, the LED is switched off temporarily. Flickering speed depends on target interface speed. At low interface speeds, operations typically take longer and the "OFF" periods are typically longer than at fast speeds.
GREEN, constant	Emulator has enumerated and is in idle mode.
GREEN, switched off for 10ms once per second	J-Link heart beat. Will be activated after the emulator has been in idle mode for at least 7 seconds.
GREEN, flashing at 1 Hz	Emulator has a fatal error. This should not normally happen.

Table 5.1: J-Link single color main indicator

5.2.1.2 Bi-color indicator (J-Link V8)

Indicator status	Meaning
GREEN, flashing at 10 Hz	Emulator enumerates.
GREEN, flickering	Emulator is in operation. Whenever the emulator is executing a command, the LED is switched off temporarily. Flickering speed depends on target interface speed. At low interface speeds, operations typically take longer and the "OFF" periods are typically longer than at fast speeds.
GREEN, constant	Emulator has enumerated and is in idle mode.
GREEN, switched off for 10ms once per second	J-Link heart beat. Will be activated after the emulator has been in idle mode for at least 7 seconds.
ORANGE	Reset is active on target.
RED, flashing at 1 Hz	Emulator has a fatal error. This should not normally happen.

Table 5.2: J-Link single color LED main color indicator

5.2.2 Input indicator

Some newer J-Links such as the J-Link Pro/Ultra come with additional input/output indicators. The input indicator is used to give the user some information about the status of the target hardware.

5.2.2.1 Bi-color input indicator

Indicator status	Meaning
GREEN	Target voltage could be measured. Target is connected.
ORANGE	Target voltage could be measured. RESET is pulled low (active) on target side.
RED	RESET is pulled low (active) on target side. If no target is connected, reset will also be active on target side.

Table 5.3: J-Link bi-color input indicator

5.2.3 Output indicator

Some newer J-Links such as the J-Link Pro/Ultra come with additional input/output indicators. The output indicator is used to give the user some information about the emulator-to-target connection.

5.2.3.1 Bi-color output indicator

Indicator status	Meaning
OFF	Target power supply via Pin 19 is not active.
GREEN	Target power supply via Pin 19 is active.
ORANGE	Target power supply via Pin 19 is active. Emulator pulls RESET low (active).
RED	Emulator pulls RESET low (active).

Table 5.4: J-Link bi-color output indicator

5.3 JTAG interface

By default, only one device is assumed to be in the JTAG scan chain. If you have multiple devices in the scan chain, you must properly configure it. To do so, you have to specify the exact position of the CPU that should be addressed. Configuration of the scan chain is done by the target application. A target application can be a debugger such as the IAR C-SPY® debugger, ARM's AXD using RDI, a flash programming application such as SEGGER's J-Flash, or any other application using J-Link / J-Trace. It is the application's responsibility to supply a way to configure the scan chain. Most applications offer a dialog box for this purpose.

5.3.1 Multiple devices in the scan chain

J-Link / J-Trace can handle multiple devices in the scan chain. This applies to hardware where multiple chips are connected to the same JTAG connector. As can be seen in the following figure, the TCK and TMS lines of all JTAG device are connected, while the TDI and TDO lines form a bus.

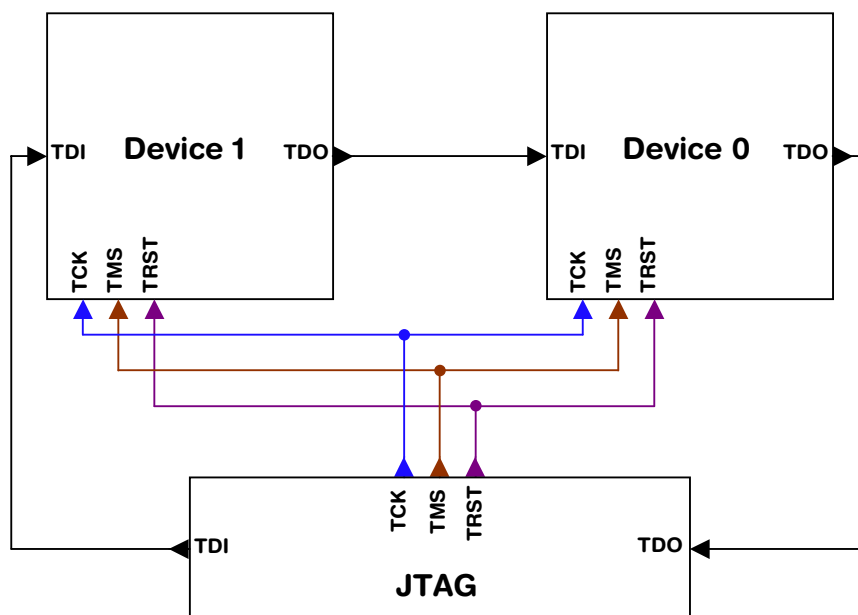

Currently, up to 8 devices in the scan chain are supported. One or more of these devices can be CPU cores; the other devices can be of any other type but need to comply with the JTAG standard.

5.3.1.1 Configuration

The configuration of the scan chain depends on the application used. Read *JTAG interface* on page 190 for further instructions and configuration examples.

5.3.2 Sample configuration dialog boxes

As explained before, it is the responsibility of the application to allow the user to configure the scan chain. This is typically done in a dialog box; some sample dialog boxes are shown below.

SEGGER J-Flash configuration dialog

This dialog box can be found at **Options|Project** settings.

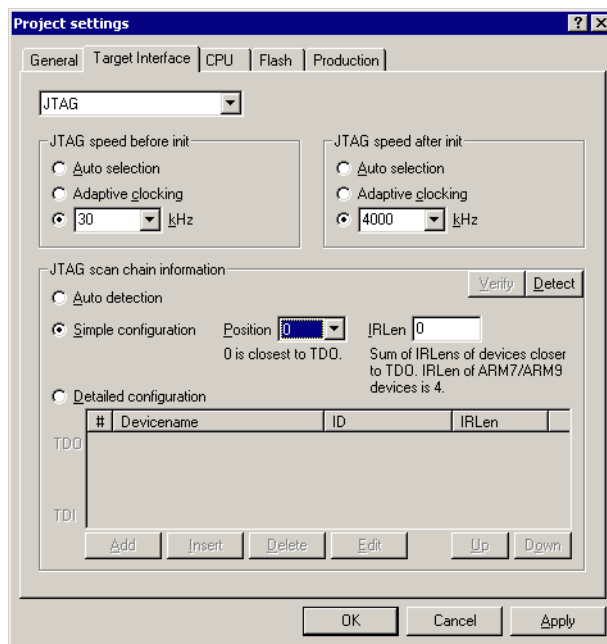

SEGGER J-Link RDI configuration dialog box

This dialog can be found under **RDI|Configure** for example in IAR Embedded Workbench®. For detailed information check the IAR Embedded Workbench user guide.

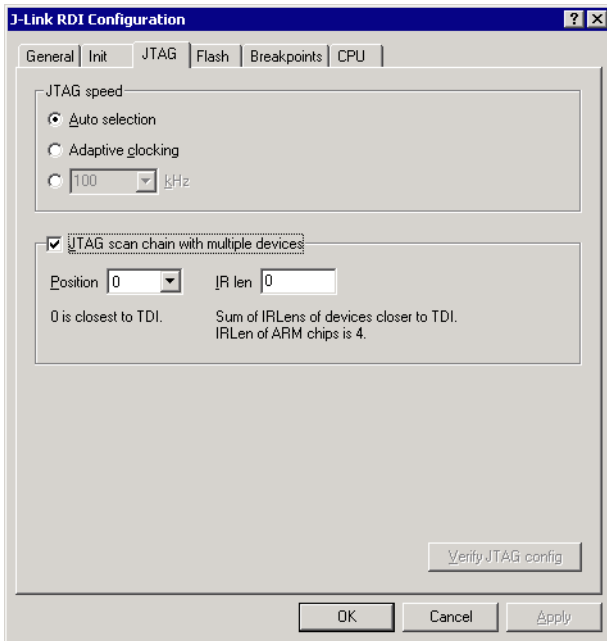

IAR J-Link configuration dialog box

This dialog box can be found under **Project|Options**.

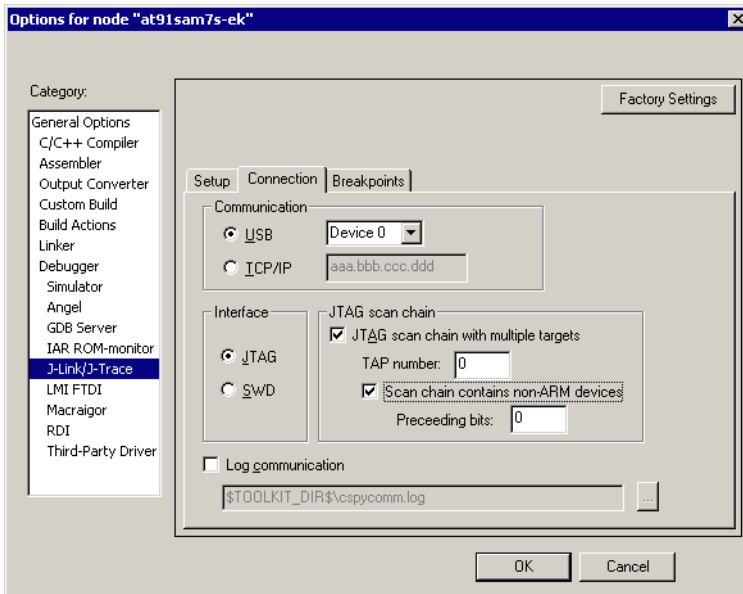

5.3.3 Determining values for scan chain configuration

When do I need to configure the scan chain?

If only one device is connected to the scan chain, the default configuration can be used. In other cases, J-Link / J-Trace may succeed in automatically recognizing the devices on the scan chain, but whether this is possible depends on the devices present on the scan chain.

How do I configure the scan chain?

2 values need to be known:

- The position of the target device in the scan chain.
- The total number of bits in the instruction registers of the devices before the target device (IR len).

The position can usually be seen in the schematic; the IR len can be found in the manual supplied by the manufacturers of the others devices.

ARM7/ARM9 have an IR len of four.

Sample configurations

The diagram below shows a scan chain configuration sample with 2 devices connected to the JTAG port.

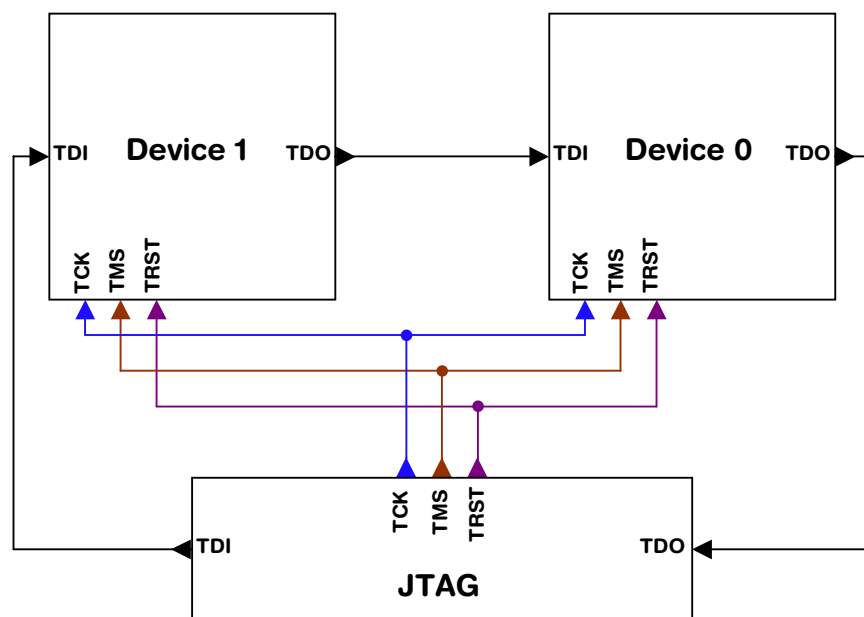

Examples

The following table shows a few sample configurations with 1,2 and 3 devices in different configurations.

Device 0 Chip(IR len)	Device 1 Chip(IR len)	Device 2 Chip(IR len)	Position	IR len
ARM (4)	-	-	0	0
ARM (4)	Xilinx(8)	-	0	0
Xilinx(8)	ARM (4)	-	1	8
Xilinx(8)	Xilinx(8)	ARM (4)	2	16

Table 5.5: Example scan chain configurations

Device 0 Chip(IR len)	Device 1 Chip(IR len)	Device 2 Chip(IR len)	Position	IR len
ARM(4)	Xilinx(8)	ARM(4)	0	0
ARM(4)	Xilinx(8)	ARM(4)	2	12
Xilinx(8)	ARM(4)	Xilinx(8)	1	8

Table 5.5: Example scan chain configurations

The target device is marked in blue.

5.3.4 JTAG Speed

There are basically three types of speed settings:

- Fixed JTAG speed.
- Automatic JTAG speed.
- Adaptive clocking.

These are explained below.

5.3.4.1 Fixed JTAG speed

The target is clocked at a fixed clock speed. The maximum JTAG speed the target can handle depends on the target itself. In general CPU cores without JTAG synchronization logic (such as ARM7-TDMI) can handle JTAG speeds up to the CPU speed, ARM cores with JTAG synchronization logic (such as ARM7-TDMI-S, ARM946E-S, ARM966EJ-S) can handle JTAG speeds up to 1/6 of the CPU speed.

JTAG speeds of more than 10 MHz are not recommended.

5.3.4.2 Automatic JTAG speed

Selects the maximum JTAG speed handled by the TAP controller.

Note: On ARM cores without synchronization logic, this may not work reliably, because the CPU core may be clocked slower than the maximum JTAG speed.

5.3.4.3 Adaptive clocking

If the target provides the RTCK signal, select the adaptive clocking function to synchronize the clock to the processor clock outside the core. This ensures there are no synchronization problems over the JTAG interface.

If you use the adaptive clocking feature, transmission delays, gate delays, and synchronization requirements result in a lower maximum clock frequency than with non-adaptive clocking.

5.4 SWD interface

The J-Link support ARM's Serial Wire Debug (SWD). SWD replaces the 5-pin JTAG port with a clock (SWDCLK) and a single bi-directional data pin (SWDIO), providing all the normal JTAG debug and test functionality. SWDIO and SWCLK are overlaid on the TMS and TCK pins. In order to communicate with a SWD device, J-Link sends out data on SWDIO, synchronous to the SWCLK. With every rising edge of SWCLK, one bit of data is transmitted or received on the SWDIO.

5.4.1 SWD speed

Currently only fixed SWD speed is supported by J-Link. The target is clocked at a fixed clock speed. The SWD speed which is used for target communication should not exceed **target CPU speed * 10**. The maximum SWD speed which is supported by J-Link depends on the hardware version and model of J-Link. For more information about the maximum SWD speed for each J-Link / J-Trace model, please refer to *J-Link / J-Trace models* on page 28.

5.4.2 SWO

Serial Wire Output (SWO) support means support for a single pin output signal from the core. The Instrumentation Trace Macrocell (ITM) and Serial Wire Output (SWO) can be used to form a Serial Wire Viewer (SWV). The Serial Wire Viewer provides a low cost method of obtaining information from inside the MCU.

Usually it should not be necessary to configure the SWO speed because this is usually done by the debugger.

5.4.2.1 Max. SWO speeds

The supported SWO speeds depend on the connected emulator. They can be retrieved from the emulator. To get the supported SWO speeds for your emulator, use J-Link Commander:

```
J-Link> si 1 //Select target interface SWD
J-Link> SWOSpeed
```

Currently, following speeds are supported:

Emulator	Speed formula	Resulting max. speed
J-Link V9	60MHz/n, n >= 8	7.5 MHz
J-Link Pro/ULTRA V4	3.2GHz/n, n >= 64	50 MHz

Table 5.6: J-Link supported SWO input speeds

5.4.2.2 Configuring SWO speeds

The max. SWO speed in practice is the max. speed which both, target and J-Link can handle. J-Link can handle the frequencies described in *SWO* on page 195 whereas the max. deviation between the target and the J-Link speed is about 3%.

The computation of possible SWO speeds is typically done in the debugger. The SWO output speed of the CPU is determined by TRACECLKIN, which is normally the same as the CPU clock.

Example1

Target CPU running at 72 MHz. n is between 1 and 8192.

Possible SWO output speeds are:

72MHz, 36MHz, 24MHz, ...

J-Link V9: Supported SWO input speeds are: 60MHz / n, n >= 8:

7.5MHz, 6.66MHz, 6MHz, ...

Permitted combinations are:

SWO output	SWO input	Deviation percent
6MHz, n = 12	6MHz, n = 10	0
4MHz, n = 18	4MHz, n = 15	0
...	...	<= 3
2MHz, n = 36	2MHz, n = 30	0
...

Table 5.7: Permitted SWO speed combinations

Example 2

Target CPU running at 10 MHz.

Possible SWO output speeds are:

10MHz, 5MHz, 3.33MHz, ...

J-Link V7: Supported SWO input speeds are: 6MHz / n, n >= 1:

6MHz, 3MHz, 2MHz, 1.5MHz, ...

Permitted combinations are:

SWO output	SWO input	Deviation percent
2MHz, n = 5	2MHz, n = 3	0
1MHz, n = 10	1MHz, n = 6	0
769kHz, n = 13	750kHz, n = 8	2.53
...

Table 5.8: Permitted SWO speed combinations

5.5 Multi-core debugging

J-Link / J-Trace is able to debug multiple cores on one target system connected to the same scan chain. Configuring and using this feature is described in this section.

5.5.1 How multi-core debugging works

Multi-core debugging requires multiple debuggers or multiple instances of the same debugger. Two or more debuggers can use the same J-Link / J-Trace simultaneously. Configuring a debugger to work with a core in a multi-core environment does not require special settings. All that is required is proper setup of the scan chain for each debugger. This enables J-Link / J-Trace to debug more than one core on a target at the same time.

The following figure shows a host, debugging two CPU cores with two instances of the same debugger.

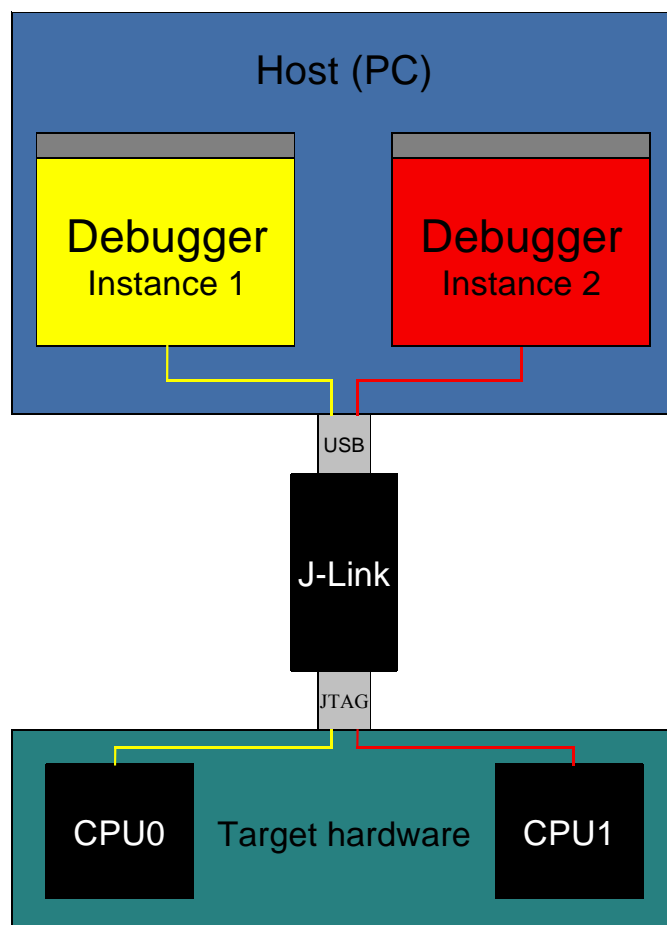

Both debuggers share the same physical connection. The core to debug is selected through the JTAG-settings as described below.

5.5.2 Using multi-core debugging in detail

1. Connect your target to J-Link / J-Trace.
2. Start your debugger, for example IAR Embedded Workbench for ARM.
3. Choose `Project|Options` and configure your scan chain. The picture below shows the configuration for the first CPU core on your target.

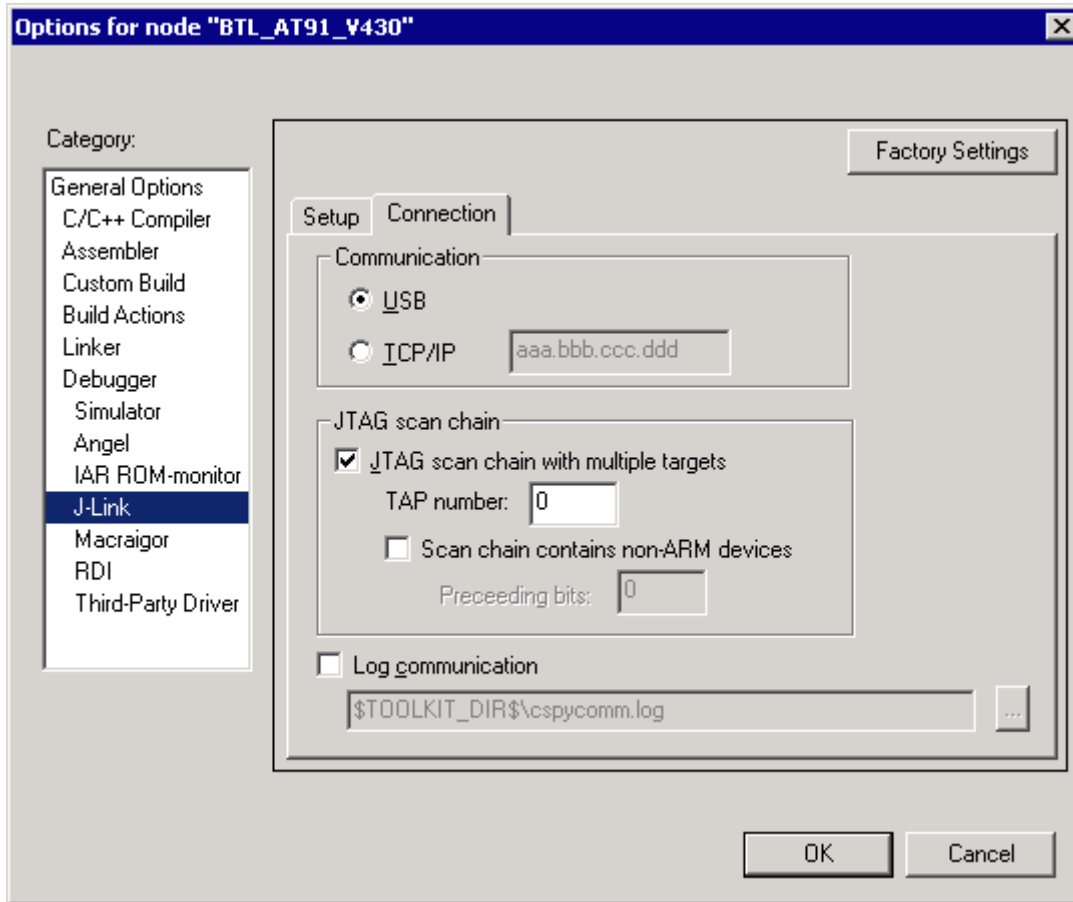

4. Start debugging the first core.
5. Start another debugger, for example another instance of IAR Embedded Workbench for ARM.

6. Choose `Project|Options` and configure your second scan chain. The following dialog box shows the configuration for the second ARM core on your target.

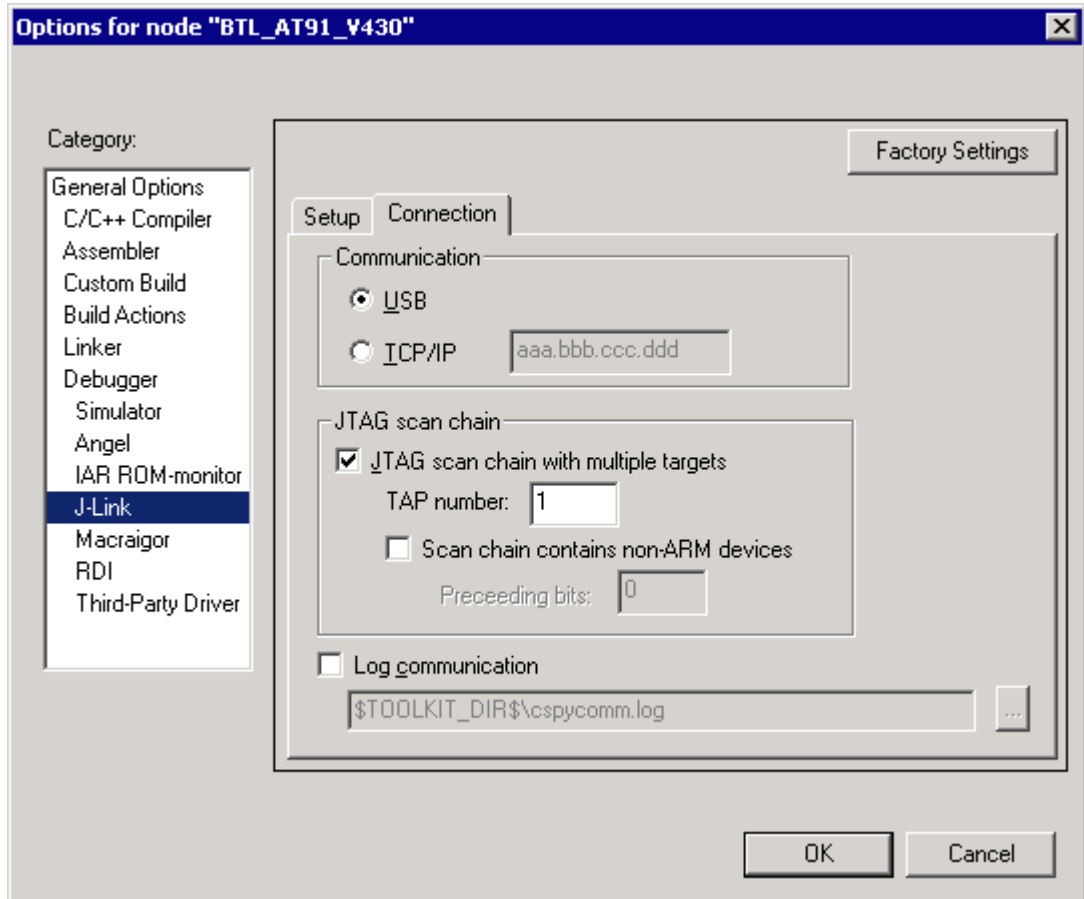

7. Start debugging your second core.

Example:

Core #1	Core #2	Core #3	TAP number debugger #1	TAP number debugger #2
ARM7TDMI	ARM7TDMI-S	ARM7TDMI	0	1
ARM7TDMI	ARM7TDMI	ARM7TDMI	0	2
ARM7TDMI-S	ARM7TDMI-S	ARM7TDMI-S	1	2

Table 5.9: Multicore debugging

Cores to debug are marked in blue.

5.5.3 Things you should be aware of

Multi-core debugging is more difficult than single-core debugging. You should be aware of the pitfalls related to JTAG speed and resetting the target.

5.5.3.1 JTAG speed

Each core has its own maximum JTAG speed. The maximum JTAG speed of all cores in the same chain is the minimum of the maximum JTAG speeds.

For example:

- Core #1: 2MHz maximum JTAG speed
- Core #2: 4MHz maximum JTAG speed
- Scan chain: 2MHz maximum JTAG speed

5.5.3.2 Resetting the target

All cores share the same RESET line. You should be aware that resetting one core through the RESET line means resetting all cores which have their RESET pins connected to the RESET line on the target.

5.6 Connecting multiple J-Links / J-Traces to your PC

In general, it is possible to have an unlimited number of J-Links / J-Traces connected to the same PC. Current J-Link models are already factory-configured to be used in a multi-J-Link environment, older J-Links can be re-configured to use them in a multi-J-link environment.

5.6.1 How does it work?

USB devices are identified by the OS by their product ID, vendor id and serial number. The serial number reported by current J-Links is a unique number which allows to have an almost unlimited number of J-Links connected to the same host at the same time. In order to connect to the correct J-Link, the user has to make sure that the correct J-Link is selected (by SN or IP). In cases where no specific J-Link is selected, following pop up will show and allow the user to select the proper J-Link:

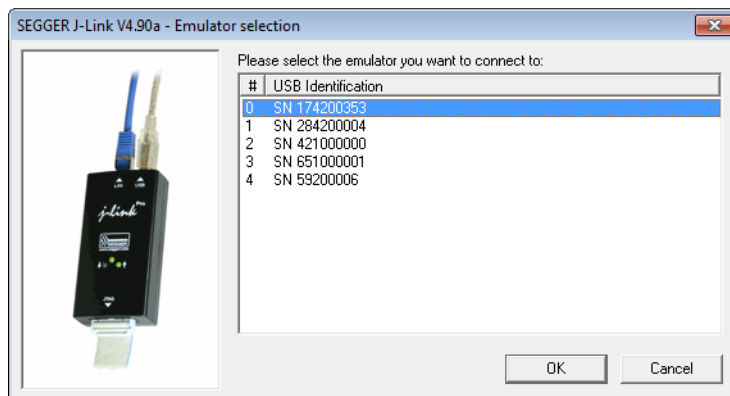

The sketch below shows a host, running two application programs. Each application-communicates with one CPU core via a separate J-Link.

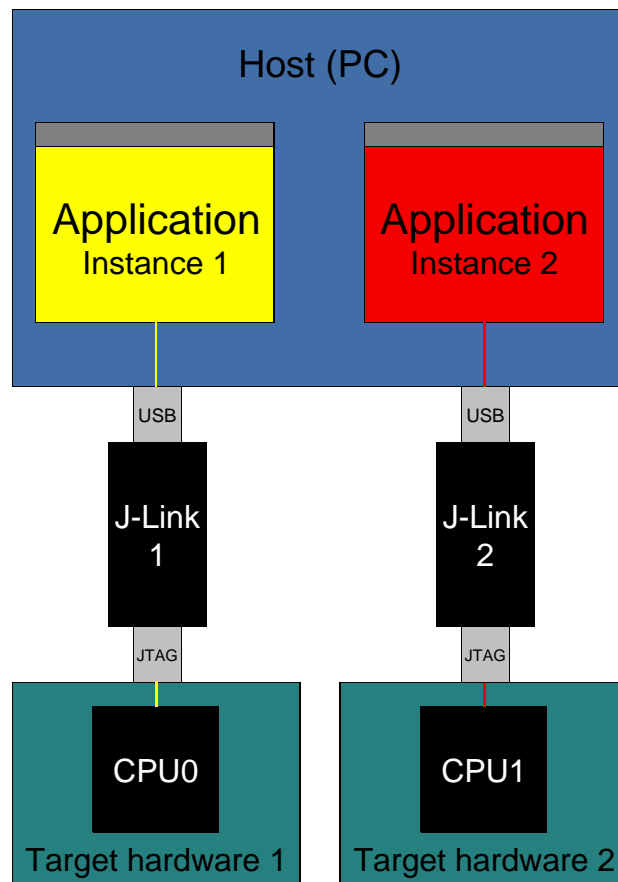

Older J-Links may report USB0-3 instead of unique serial number when enumerating via USB. For these J-Links, we recommend to re-configure them to use the new enumeration method (report real serial number) since the USB0-3 behavior is obsolete.

Re-configuration can be done by using the J-Link Configurator, which is part of the J-Link software and documentation package. For further information about the J-Link configurator and how to use it, please refer to *J-Link Configurator* on page 177.

Re-configuration to the old USB 0-3 enumeration method

In some special cases, it may be necessary to switch back to the obsolete USB 0-3 enumeration method. For example, old IAR EWARM versions supports connecting to a J-Link via the USB0-3 method only. As soon as more than one J-Link is connected to the pc, there is no opportunity to pre-select the J-Link which should be used for a debug session.

Below, a small instruction of how to re-configure J-Link to enumerate with the old obsolete enumeration method in order to prevent compatibility problems, a short instruction is give on how to set USB enumeration method to USB 2 is given:

Config area byte	Meaning
0	USB-Address. Can be set to 0-3, 0xFF is default which means USB-Address 0.
1	Enumeration method 0x00 / 0xFF: USB-Address is used for enumeration. 0x01: Real-SN is used for enumeration.

Table 5.10: Config area layout: USB-Enumeration settings

Example for setting enumeration method to USB 2:

1. Start J-Link Commander (JLink.exe) which is part of the J-Link software
2. Enter `wconf 0 02` // Set USB-Address 2
3. Enter `wconf 1 00` // Set enumeration method to USB-Address
4. Power-cycle J-Link in order to apply new configuration.

Re-configuration to REAL-SN enumeration can be done by using the J-Link Configurator, which is part of the J-Link software and documentation package. For further information about the J-Link configurator and how to use it, please refer to *J-Link Configurator* on page 177.

5.7 J-Link control panel

Since software version V3.86 J-Link the J-Link control panel window allows the user to monitor the J-Link status and the target status information in real-time. It also allows the user to configure the use of some J-Link features such as flash download, flash breakpoints and instruction set simulation. The J-Link control panel window can be accessed via the J-Link tray icon in the tray icon list. This icon is available when the debug session is started.



To open the status window, simply click on the tray icon.

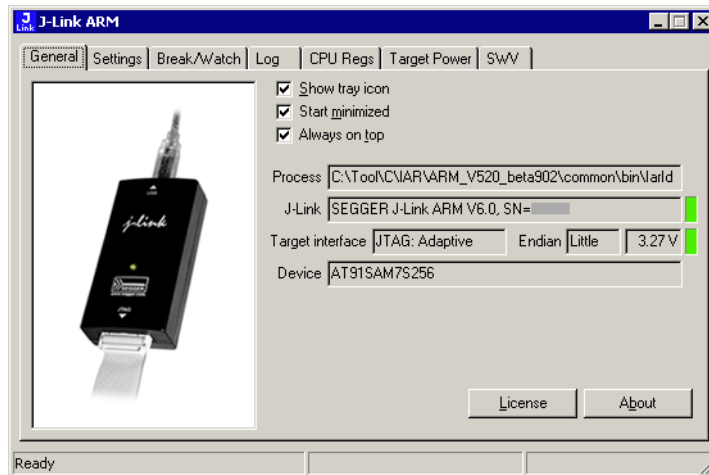

5.7.1 Tabs

The J-Link status window supports different features which are grouped in tabs. The organization of each tab and the functionality which is behind these groups will be explained in this section

5.7.1.1 General

In the **General** section, general information about J-Link and the target hardware are shown. Moreover the following general settings can be configured:

- **Show tray icon:** If this checkbox is disabled the tray icon will not show from the next time the DLL is loaded.
- **Start minimized:** If this checkbox is disabled the J-Link status window will show up automatically each time the DLL is loaded.
- **Always on top:** if this checkbox is enabled the J-Link status window is always visible even if other windows will be opened.

The general information about target hardware and J-Link which are shown in this section, are:

- **Process:** Shows the path of the file which loaded the DLL.
- **J-Link:** Shows OEM of the connected J-Link, the hardware version and the Serial number. If no J-Link is connected it shows "not connected" and the color indicator is red.
- **Target interface:** Shows the selected target interface (JTAG/SWD) and the current JTAG speed. The target current is also shown. (Only visible if J-Link is connected)
- **Endian:** Shows the target endianness (Only visible if J-Link is connected)
- **Device:** Shows the selected device for the current debug session.
- **License:** Opens the J-Link license manager.
- **About:** Opens the about dialog.

5.7.1.2 Settings

In the **Settings** section project- and debug-specific settings can be set. It allows the configuration of the use of flash download and flash breakpoints and some other target specific settings which will be explained in this topic. Settings are saved in the configuration file. This configuration file needs to be set by the debugger. If the debugger does not set it, settings can not be saved. All settings which are modified during the debug session have to be saved by pressing **Save settings**, otherwise they are lost when the debug session is closed.

Section: Flash download

In this section, settings for the use of the J-Link FlashDL feature and related settings can be configured. When a license for J-Link FlashDL is found, the color indicator is green and "License found" appears right to the J-Link FlashDL usage settings.

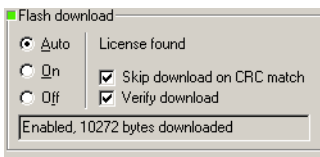

- **Auto:** This is the default setting of J-Link FlashDL usage. If a license is found J-Link FlashDL is enabled. Otherwise J-Link FlashDL will be disabled internally.
- **On:** Enables the J-Link FlashDL feature. If no license has been found an error message appears.
- **Off:** Disables the J-Link FlashDL feature.
- **Skip download on CRC match:** J-Link checks the CRC of the flash content to determine if the current application has already been downloaded to the flash. If a CRC match occurs, the flash download is not necessary and skipped. (Only available if J-Link FlashDL usage is configured as **Auto** or **On**)
- **Verify download:** If this checkbox is enabled J-Link verifies the flash content after the download. (Only available if J-Link FlashDL usage is configured as **Auto** or **On**)

Section: Flash breakpoints:

In this section, settings for the use of the FlashBP feature and related settings can be configured. When a license for FlashBP is found, the color indicator is green and "License found" appears right to the FlashBP usage settings.

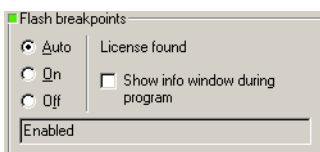

- **Auto:** This is the default setting of FlashBP usage. If a license has been found the FlashBP feature will be enabled. Otherwise FlashBP will be disabled internally.
- **On:** Enables the FlashBP feature. If no license has been found an error message appears.
- **Off:** Disables the FlashBP feature.
- **Show window during program:** When this checkbox is enabled the "Programming flash" window is shown when flash is re-programmed in order to set/clear flash breakpoints.

Flash download and flash breakpoints independent settings

These settings do not belong to the J-Link flash download and flash breakpoints settings section. They can be configured without any license needed.

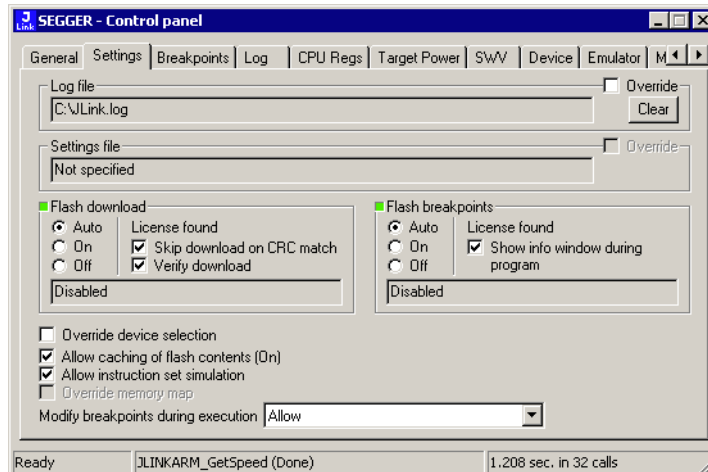

- **Log file:** Shows the path where the J-Link log file is placed. It is possible to override the selection manually by enabling the Override checkbox. If the Override checkbox is enabled a button appears which let the user choose the new location of the log file.
- **Settings file:** Shows the path where the configuration file is placed. This configuration file contains all the settings which can be configured in the **Settings** tab.
- **Override device selection:** If this checkbox is enabled, a dropdown list appears, which allows the user to set a device manually. This especially makes sense when J-Link can not identify the device name given by the debugger or if a particular device is not yet known to the debugger, but to the J-Link software.
- **Allow caching of flash contents:** If this checkbox is enabled, the flash contents are cached by J-Link to avoid reading data twice. This speeds up the transfer between debugger and target.
- **Allow instruction set simulation:** If this checkbox is enabled, instructions will be simulated as far as possible. This speeds up single stepping, especially when FlashBPs are used.
- **Save settings:** When this button is pushed, the current settings in the **Settings** tab will be saved in a configuration file. This file is created by J-Link and will be created for each project and each project configuration (e.g. Debug_RAM, Debug_Flash). If no settings file is given, this button is not visible.
- **Modify breakpoints during execution:** This dropdown box allows the user to change the behavior of the DLL when setting breakpoints if the CPU is running. The following options are available:
 - Allow:** Allows settings breakpoints while the CPU is running. If the CPU needs to be halted in order to set the breakpoint, the DLL halts the CPU, sets the breakpoints and restarts the CPU.
 - Allow if CPU does not need to be halted:** Allows setting breakpoints while the CPU is running, if it does not need to be halted in order to set the breakpoint. If the CPU has to be halted the breakpoint is not set.
 - Ask user if CPU needs to be halted:** If the user tries to set a breakpoint while the CPU is running and the CPU needs to be halted in order to set the breakpoint, the user is asked if the breakpoint should be set. If the breakpoint can be set without halting the CPU, the breakpoint is set without explicit confirmation by the user.
 - Do not allow:** It is not allowed to set breakpoints while the CPU is running.

5.7.1.3 Break/Watch

In the Break/Watch section all breakpoints and watchpoints which are in the DLL internal breakpoint and watchpoint list are shown.

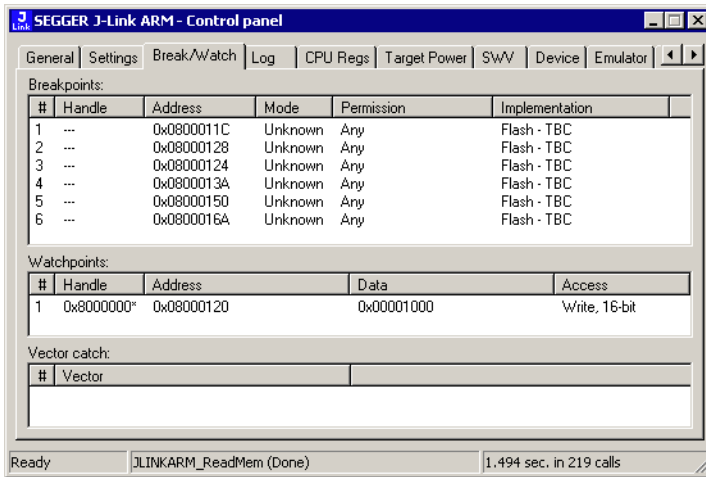

Section: Code

Lists all breakpoints which are in the DLL internal breakpoint list are shown.

- **Handle:** Shows the handle of the breakpoint.
- **Address:** Shows the address where the breakpoint is set.
- **Mode:** Describes the breakpoint type (ARM/THUMB)
- **Permission:** Describes the breakpoint implementation flags.
- **Implementation:** Describes the breakpoint implementation type. The breakpoint types are: RAM, Flash, Hard. An additional TBC (to be cleared) or TBS (to be set) gives information about if the breakpoint is (still) written to the target or if it's just in the breakpoint list to be written/cleared.

Note: It is possible for the debugger to bypass the breakpoint functionality of the J-Link software by writing to the debug registers directly. This means for ARM7/ARM9 cores write accesses to the ICE registers, for Cortex-M3 devices write accesses to the memory mapped flash breakpoint registers and in general simple write accesses for software breakpoints (if the program is located in RAM). In these cases, the J-Link software cannot determine the breakpoints set and the list is empty.

Section: Data

In this section, all data breakpoints which are listed in the DLL internal breakpoint list are shown.

- **Handle:** Shows the handle of the data breakpoint.
- **Address:** Shows the address where the data breakpoint is set.
- **AddrMask:** Specifies which bits of **Address** are disregarded during the comparison for a data breakpoint match. (A 1 in the mask means: disregard this bit)
- **Data:** Shows on which data to be monitored at the address where the data breakpoint is set.
- **Data Mask:** Specifies which bits of **Data** are disregarded during the comparison for a data breakpoint match. (A 1 in the mask means: disregard this bit)
- **Ctrl:** Specifies the access type of the data breakpoint (read/write).
- **CtrlMask:** Specifies which bits of Ctrl are disregarded during the comparison for a data breakpoint match.

5.7.1.4 Log

In this section the log output of the DLL is shown. The user can determine which function calls should be shown in the log window.

Available function calls to log: Register read/write, Memory read/write, set/clear breakpoint, step, go, halt, is halted.

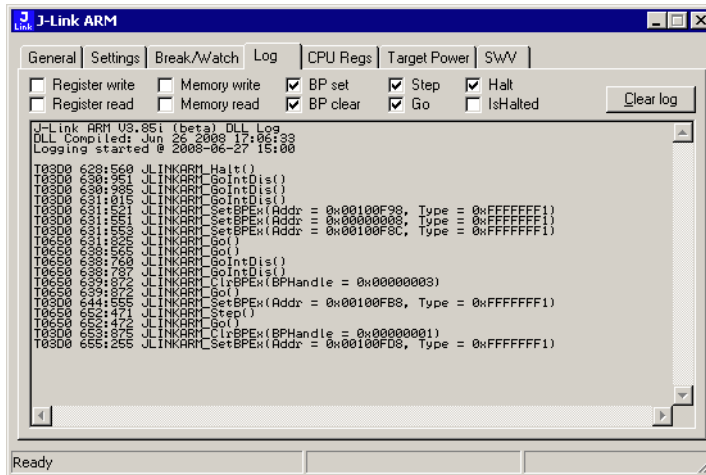

5.7.1.5 CPU Regs

In this section the name and the value of the CPU registers are shown.

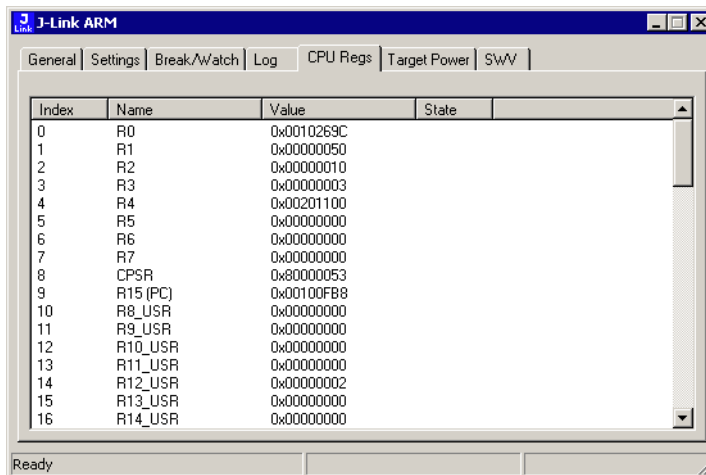

5.7.1.6 Target Power

In this section currently just the power consumption of the target hardware is shown.

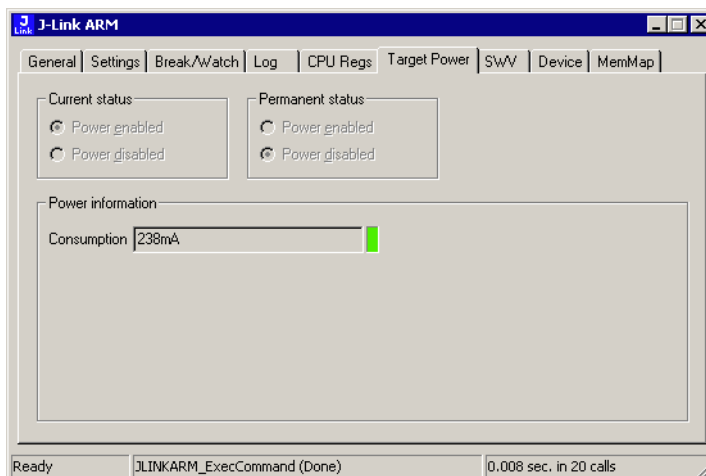

5.7.1.7 SWV

In this section SWV information are shown.

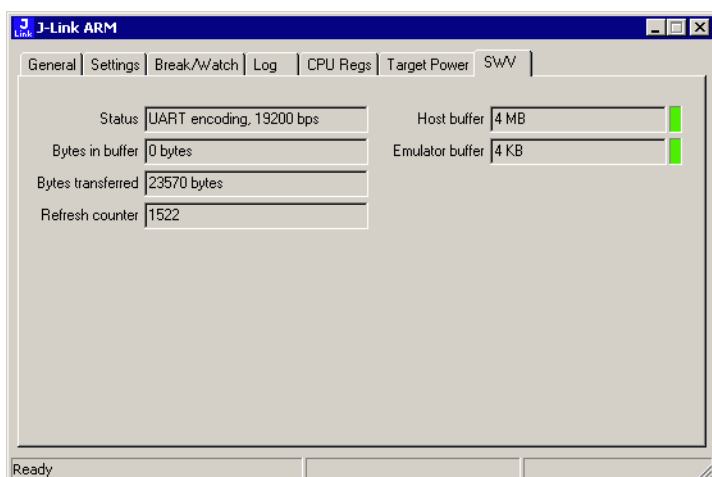

- **Status:** Shows the encoding and the baudrate of the SWV data received by the target (Manchester/UART, currently J-Link only supports UART encoding).
- **Bytes in buffer:** Shows how many bytes are in the DLL SWV data buffer.
- **Bytes transferred:** Shows how many bytes have been transferred via SWV, since the debug session has been started.
- **Refresh counter:** Shows how often the SWV information in this section has been updated since the debug session has been started.
- **Host buffer:** Shows the reserved buffer size for SWV data, on the host side.
- **Emulator buffer:** Shows the reserved buffer size for SWV data, on the emulator side.

5.8 Reset strategies

J-Link / J-Trace supports different reset strategies. This is necessary because there is no single way of resetting and halting a CPU core before it starts to execute instructions. For example reset strategies which use the reset pin can not succeed on targets where the reset pin of the CPU is not connected to the reset pin of the JTAG connector. Reset strategy 0 is always the recommended one because it has been adapted to work on every target even if the reset pin (Pin 15) is not connected.

What is the problem if the core executes some instructions after RESET?

The instructions which are executed can cause various problems. Some cores can be completely "confused", which means they can not be switched into debug mode (CPU can not be halted). In other cases, the CPU may already have initialized some hardware components, causing unexpected interrupts or worse, the hardware may have been initialized with illegal values. In some of these cases, such as illegal PLL settings, the CPU may be operated beyond specification, possibly locking the CPU.

5.8.1 Strategies for ARM 7/9 devices

5.8.1.1 Type 0: Hardware, halt after reset (normal)

The hardware reset pin is used to reset the CPU. After reset release, J-Link continuously tries to halt the CPU. This typically halts the CPU shortly after reset release; the CPU can in most systems execute some instructions before it is halted. The number of instructions executed depends primarily on the JTAG speed: the higher the JTAG speed, the faster the CPU can be halted.

Some CPUs can actually be halted before executing any instruction, because the start of the CPU is delayed after reset release. If a pause has been specified, J-Link waits for the specified time before trying to halt the CPU. This can be useful if a bootloader which resides in flash or ROM needs to be started after reset.

This reset strategy is typically used if nRESET and nTRST are coupled. If nRESET and nTRST are coupled, either on the board or the CPU itself, reset clears the breakpoint, which means that the CPU can not be stopped after reset with the BP@0 reset strategy.

5.8.1.2 Type 1: Hardware, halt with BP@0

The hardware reset pin is used to reset the CPU. Before doing so, the ICE breaker is programmed to halt program execution at address 0; effectively, a breakpoint is set at address 0. If this strategy works, the CPU is actually halted before executing a single instruction.

This reset strategy does not work on all systems for two reasons:

- If nRESET and nTRST are coupled, either on the board or the CPU itself, reset clears the breakpoint, which means the CPU is not stopped after reset.
- Some MCUs contain a bootloader program (sometimes called kernel), which needs to be executed to enable JTAG access.

5.8.1.3 Type 2: Software, for Analog Devices ADuC7xxx MCUs

This reset strategy is a software strategy. The CPU is halted and performs a sequence which causes a peripheral reset. The following sequence is executed:

- The CPU is halted.
- A software reset sequence is downloaded to RAM.
- A breakpoint at address 0 is set.
- The software reset sequence is executed.

This sequence performs a reset of CPU and peripherals and halts the CPU before executing instructions of the user program. It is the recommended reset sequence for Analog Devices ADuC7xxx MCUs and works with these chips only.

5.8.1.4 Type 3: No reset

No reset is performed. Nothing happens.

5.8.1.5 Type 4: Hardware, halt with WP

The hardware RESET pin is used to reset the CPU. After reset release, J-Link continuously tries to halt the CPU using a watchpoint. This typically halts the CPU shortly after reset release; the CPU can in most systems execute some instructions before it is halted.

The number of instructions executed depends primarily on the JTAG speed: the higher the JTAG speed, the faster the CPU can be halted. Some CPUs can actually be halted before executing any instruction, because the start of the CPU is delayed after reset release

5.8.1.6 Type 5: Hardware, halt with DBGRQ

The hardware RESET pin is used to reset the CPU. After reset release, J-Link continuously tries to halt the CPU using the DBGRQ. This typically halts the CPU shortly after reset release; the CPU can in most systems execute some instructions before it is halted.

The number of instructions executed depends primarily on the JTAG speed: the higher the JTAG speed, the faster the CPU can be halted. Some CPUs can actually be halted before executing any instruction, because the start of the CPU is delayed after reset release.

5.8.1.7 Type 6: Software

This reset strategy is only a software reset. "Software reset" means basically no reset, just changing the CPU registers such as PC and CPSR. This reset strategy sets the CPU registers to their after-Reset values:

- PC = 0
- CPSR = 0xD3 (Supervisor mode, ARM, IRQ / FIQ disabled)
- All SPSR registers = 0x10
- All other registers (which are unpredictable after reset) are set to 0.
- The hardware RESET pin is not affected.

5.8.1.8 Type 7: Reserved

Reserved reset type.

5.8.1.9 Type 8: Software, for ATMEL AT91SAM7 MCUs

The reset pin of the device is disabled by default. This means that the reset strategies which rely on the reset pin (low pulse on reset) do not work by default. For this reason a special reset strategy has been made available.

It is recommended to use this reset strategy. This special reset strategy resets the peripherals by writing to the RSTC_CR register. Resetting the peripherals puts all peripherals in the defined reset state. This includes memory mapping register, which means that after reset flash is mapped to address 0. It is also possible to achieve the same effect by writing 0x4 to the RSTC_CR register located at address 0xffffd00.

5.8.1.10 Type 9: Hardware, for NXP LPC MCUs

After reset a bootloader is mapped at address 0 on ARM 7 LPC devices. This reset strategy performs a reset via reset strategy Type 1 in order to reset the CPU. It also ensures that flash is mapped to address 0 by writing the MEMMAP register of the LPC. This reset strategy is the recommended one for all ARM 7 LPC devices.

5.8.2 Strategies for Cortex-M devices

J-Link supports different specific reset strategies for the Cortex-M cores. All of the following reset strategies are available in JTAG and in SWD mode. All of them halt the CPU after the reset.

Note: It is recommended that the correct device is selected in the debugger so the debugger can pass the device name to the J-Link DLL which makes it possible for J-Link to detect what is the best reset strategy for the device. Moreover, we recommend that the debugger uses reset type 0 to allow J-Link to dynamically select what reset is the best for the connected device.

5.8.2.1 Type 0: Normal

This is the default strategy. It does whatever is the best way to reset the target device.

If the correct device is selected in the debugger this reset strategy may also perform some special handling which might be necessary for the connected device. This for example is the case for devices which have a ROM bootloader that needs to run after reset and before the user application is started (especially if the debug interface is disabled after reset and needs to be enabled by the ROM bootloader).

For most devices, this reset strategy does the same as reset strategy 8 does:

1. Make sure that the device halts immediately after reset (before it can execute any instruction of the user application) by setting the `VC_CORERESSET` in the `DEMCR`.
2. Reset the core and peripherals by setting the `SYSRESETREQ` bit in the `AIRCR`.
3. Wait for the `S_RESET_ST` bit in the `DHCSR` to first become high (reset active) and then low (reset no longer active) afterwards.
4. Clear `VC_CORERESSET`.

5.8.2.2 Type 1: Core

Only the core is reset via the `VECTRESET` bit. The peripherals are not affected. After setting the `VECTRESET` bit, J-Link waits for the `S_RESET_ST` bit in the Debug Halting Control and Status Register (`DHCSR`) to first become high and then low afterwards. The CPU does not start execution of the program because J-Link sets the `VC_CORERESSET` bit before reset, which causes the CPU to halt before execution of the first instruction.

Note: In most cases it is not recommended to reset the core only since most target applications rely on the reset state of some peripherals (PLL, External memory interface etc.) and may be confused if they boot up but the peripherals are already configured.

5.8.2.3 Type 2: ResetPin

J-Link pulls its `RESET` pin low to reset the core and the peripherals. This normally causes the CPU `RESET` pin of the target device to go low as well, resulting in a reset of both CPU and peripherals. This reset strategy will fail if the `RESET` pin of the target device is not pulled low. The CPU does not start execution of the program because J-Link sets the `VC_CORERESSET` bit before reset, which causes the CPU to halt before execution of the first instruction.

5.8.2.4 Type 3: Connect under Reset

J-Link connects to the target while keeping Reset active (reset is pulled low and remains low while connecting to the target). This is the recommended reset strategy for STM32 devices. This reset strategy has been designed for the case that communication with the core is not possible in normal mode so the `VC_CORERESSET` bit can not be set in order to guarantee that the core is halted immediately after reset.

5.8.2.5 Type 4: Reset core & peripherals, halt after bootloader

Same as type 0, but bootloader is always executed. This reset strategy has been designed for MCUs/CPU's which have a bootloader located in ROM which needs to run at first, after reset (since it might initialize some target settings to their reset state). When using this reset strategy, J-Link will let the bootloader run after reset and halts the target immediately after the bootloader and before the target application is started. This is the recommended reset strategy for LPC11xx and LPC13xx devices where a bootloader should execute after reset to put the chip into the "real" reset state.

5.8.2.6 Type 5: Reset core & peripherals, halt before bootloader

Basically the same as reset type 8. Performs a reset of core & peripherals and halts the CPU immediately after reset. The ROM bootloader is NOT executed.

5.8.2.7 Type 6: Reset for Freescale Kinetis devices

Performs a via reset strategy 0 (normal) first in order to reset the core & peripherals and halt the CPU immediately after reset. After the CPU is halted, the watchdog is disabled, since the watchdog is running after reset by default. If the target application does not feed the watchdog, J-Link loses connection to the device since it is reset permanently.

5.8.2.8 Type 7: Reset for Analog Devices CPUs (ADI Halt after kernel)

Performs a reset of the core and peripherals by setting the `SYSRESETREQ` bit in the `AIRCR`. The core is allowed to perform the ADI kernel (which enables the debug interface) but the core is halted before the first instruction after the kernel is executed in order to guarantee that no user application code is performed after reset.

5.8.2.9 Type 8: Reset core and peripherals

J-Link tries to reset both, core and peripherals by setting the `SYSRESETREQ` bit in the `AIRCR`. `VC_CORERESSET` in the `DEMCR` is also set to make sure that the CPU is halted immediately after reset and before executing any instruction.

Reset procedure:

1. Make sure that the device halts immediately after reset (before it can execute any instruction of the user application) by setting the `VC_CORERESSET` in the `DEMCR`.
2. Reset the core and peripherals by setting the `SYSRESETREQ` bit in the `AIRCR`.
3. Wait for the `S_RESET_ST` bit in the `DHCSR` to first become high (reset active) and then low (reset no longer active) afterwards.
4. Clear `VC_CORERESSET`.

This type of reset may fail if:

- J-Link has no connection to the debug interface of the CPU because it is in a low power mode.
- The debug interface is disabled after reset and needs to be enabled by a device internal bootloader. This would cause J-Link to lose communication after reset since the CPU is halted before it can execute the internal bootlader.

5.8.2.10 Type 9: Reset for LPC1200 devices

On the NXP LPC1200 devices the watchdog is enabled after reset and not disabled by the bootloader, if a valid application is in the flash memory. Moreover, the watchdog keeps counting if the CPU is in debug mode. When using this reset strategy, J-Link performs a reset of the CPU and peripherals, using the `SYSRESETREQ` bit in the `AIRCR` and halts the CPU after the bootloader has been performed and before the first

instruction of the user code is executed. Then the watchdog of the LPC1200 device is disabled. This reset strategy is only guaranteed to work on "modern" J-Links (J-Link V8, J-Link Pro, J-link ULTRA, J-Trace for Cortex-M, J-Link Lite) and if a SWD speed of min. 1 MHz is used. This reset strategy should also work for J-Links with hardware version 6, but it can not be guaranteed that these J-Links are always fast enough in disabling the watchdog.

5.8.2.11 Type 10: Reset for Samsung S3FN60D devices

On the Samsung S3FN60D devices the watchdog may be running after reset (if the watchdog is active after reset or not depends on content of the smart option bytes at addr 0xC0). The watchdog keeps counting even if the CPU is in debug mode (e.g. halted by a halt request or halted by vector catch). When using this reset strategy, J-Link performs a reset of the CPU and peripherals, using the `SYSRESETREQ` bit and sets `VC_CORERESET` in order to halt the CPU after reset, before it executes a single instruction. Then the watchdog of the S3FN60D device is disabled.

5.9 Using DCC for memory access

The ARM7/9 architecture requires cooperation of the CPU to access memory when the CPU is running (not in debug mode). This means that memory cannot normally be accessed while the CPU is executing the application program. The normal way to read or write memory is to halt the CPU (put it into debug mode) before accessing memory. Even if the CPU is restarted after the memory access, the real time behavior is significantly affected; halting and restarting the CPU costs typically multiple milliseconds. For this reason, most debuggers do not even allow memory access if the CPU is running.

However, there is one other option: DCC (Direct communication channel) can be used to communicate with the CPU while it is executing the application program. All that is required is the application program to call a DCC handler from time to time. This DCC handler typically requires less than 1 μ s per call.

The DCC handler, as well as the optional DCC abort handler, is part of the J-Link software package and can be found in the `Samples\DCC\IAR` directory of the package.

5.9.1 What is required?

- An application program on the host (typically a debugger) that uses DCC.
- A target application program that regularly calls the DCC handler.
- The supplied abort handler should be installed (optional).

An application program that uses DCC is `JLink.exe`.

5.9.2 Target DCC handler

The target DCC handler is a simple C-file taking care of the communication. The function `DCC_Process()` needs to be called regularly from the application program or from an interrupt handler. If an RTOS is used, a good place to call the DCC handler is from the timer tick interrupt. In general, the more often the DCC handler is called, the faster memory can be accessed. On most devices, it is also possible to let the DCC generate an interrupt which can be used to call the DCC handler.

5.9.3 Target DCC abort handler

An optional DCC abort handler (a simple assembly file) can be included in the application. The DCC abort handler allows data aborts caused by memory reads/writes via DCC to be handled gracefully. If the data abort has been caused by the DCC communication, it returns to the instruction right after the one causing the abort, allowing the application program to continue to run. In addition to that, it allows the host to detect if a data abort occurred.

In order to use the DCC abort handler, 3 things need to be done:

- Place a branch to `DCC_Abort` at address `0x10` ("vector" used for data aborts).
- Initialize the Abort-mode stack pointer to an area of at least 8 bytes of stack memory required by the handler.
- Add the DCC abort handler assembly file to the application.

5.10 The J-Link settings file

Most IDEs provide a path to a J-Link settings file on a per-project-per-debug-configuration basis. This file is used by J-Link to store various debug settings that shall survive between debug sessions of a project. It also allows the user to perform some override of various settings. If a specific behavior / setting can be overridden via the settings file, is explained in the specific sections that describe the behavior / setting. Since the location and name of the settings file is different for various IDEs, in the following the location and naming convention of the J-Link settings file for various IDEs is explained.

5.10.1 SEGGER Embedded Studio

Settings file with default settings is created on first start of a debug session. There is one settings file per build configuration for the project.

Naming is: `_<ProjectName>_<DebugConfigName>.jlink`

The settings file is created in the same directory where the project file (*.emProject) is located.

Example: The SES project is called "MyProject" and has two configurations "Debug" and "Release". For each of the configurations, a settings file will be created at the first start of the debug session:

```
_MyProject_Debug.jlink
_MyProject_Release.jlink
```

5.10.2 Keil MDK-ARM (uVision)

Settings file with default settings is created on first start of a debug session. There is one settings file per project.

Naming is: `JLinksettings.ini`

The settings file is created in the same directory where the project file (*.uvprojx) is located.

5.10.3 IAR EWARM

Settings file with default settings is created on first start of a debug session. There is one settings file per build configuration for the project.

Naming is: `<ProjectName>_<DebugConfig>.jlink`

The settings file is created in a "settings" subdirectory where the project file is located.

5.10.4 Mentor Sourcery CodeBench for ARM

CodeBench does not directly specify a J-Link settings file but allows the user to specify a path to one in the project settings under **Debugger -> Settings File**. We recommend to copy the J-Link settings file template from `$JLINK_INST_DIR$\Samples\JLink\SettingsFiles\Sample.jlinksettings` to the directory where the CodeBench project is located, once when creating a new project. Then select this file in the project options.

5.11 J-Link script files

In some situations it is necessary to customize some actions performed by J-Link. In most cases it is the connection sequence and/or the way in which a reset is performed by J-Link, since some custom hardware needs some special handling which cannot be integrated into the generic part of the J-Link software. J-Link script files are written in C-like syntax in order to have an easy start to learning how to write J-Link script files. The script file syntax supports most statements (if-else, while, declaration of variables, ...) which are allowed in C, but not all of them. Moreover, there are some statements that are script file specific. The script file allows maximum flexibility, so almost any target initialization which is necessary can be supported.

5.11.1 Actions that can be customized

The script file support allows customizing of different actions performed by J-Link. Depending on whether the corresponding function is present in the script file or not, a generically implemented action is replaced by an action defined in a script file. In the following all J-Link actions which can be customized using a script file are listed and explained.

5.11.1.1 ConfigTargetSettings()

Description

Called before `InitTarget()`. Mainly used to set some global DLL variables to customize the normal connect procedure. For ARM CoreSight devices this may be specifying the base address of some CoreSight components (ETM, ...) that cannot be auto-detected by J-Link due to erroneous ROM tables etc. May also be used to specify the device name in case debugger does not pass it to the DLL.

Prototype

```
void ConfigTargetSettings(void);
```

Notes / Limitations

- May not, under absolutely NO circumstances, call any API functions that perform target communication.
- Should only set some global DLL variables

5.11.1.2 InitTarget()

Description

Replaces the target-CPU-auto-find procedure of the J-Link DLL. Useful for target CPUs that are not accessible by default and need some special steps to be executed before the normal debug probe connect procedure can be executed successfully. Example devices are MCUs from TI which have a so-called ICEPick JTAG unit on them that needs to be configured via JTAG, before the actual CPU core is accessible via JTAG.

Prototype

```
void InitTarget(void);
```

Notes / Limitations

- If target interface JTAG is used: JTAG chain has to be specified manually before leaving this function (meaning all devices and their TAP IDs have to be specified by the user). Also appropriate JTAG TAP number to communicate with during the debug session has to be manually specified in this function.
- MUST NOT use any MEM_ API functions
- Global DLL variable "CPU" MUST be set when implementing this function, so the DLL knows which CPU module to use internally.

5.11.1.3 SetupTarget()

Description

If present, called after `InitTarget()` and after general debug connect sequence has been performed by J-Link. Usually used for more high-level CPU debug setup like writing certain memory locations, initializing PLL for faster download etc.

Prototype

```
void SetupTarget(void);
```

Notes / Limitations

- Does not replace any DLL functionality but extends it.
- May use MEM_ API functions

5.11.1.4 ResetTarget()

Description

Replaces reset strategies of DLL. No matter what reset type is selected in the DLL, if this function is present, it will be called instead of the DLL internal reset

Prototype

```
void ResetTarget(void);
```

Notes / Limitations

- DLL expects target CPU to be halted / in debug mode, when leaving this function
- May use MEM_ API functions

5.11.1.5 InitEMU()

Description

If present, it allows configuration of the emulator prior to starting target communication. Currently this function is only used to configure whether the target which is connected to J-Link has an ETB or not. For more information on how to configure the existence of an ETB, please refer to *Global DLL variables* on page 223.

Prototype

```
void InitEMU(void);
```

5.11.1.6 OnTraceStop()

Description

Called right before capturing of trace data is stopped on the J-Link / J-Trace. On some target, an explicit flush of the trace FIFOs is necessary to get the latest trace data. If such a flush is not performed, the latest trace data may not be output by the target

Prototype

```
void OnTraceStop(void);
```

Notes / Limitations

- May use MEM_ functions

5.11.2 Script file API functions

In the following, the API functions which can be used in a script file to communicate with the DLL are explained.

5.11.2.1 MessageBox()

Description

Outputs a string in a message box.

Prototype

```
__api__ int MessageBox(const char * sMsg);
```

5.11.2.2 MessageBox1()

Description

Outputs a constant character string in a message box. In addition to that, a given value (can be a constant value, the return value of a function or a variable) is added, right behind the string.

Prototype

```
__api__ int MessageBox1(const char * sMsg, int v);
```

5.11.2.3 Report()

Description

Outputs a constant character string on stdio.

Prototype

```
__api__ int Report(const char * sMsg);
```

5.11.2.4 Report1()

Description

Outputs a constant character string on stdio. In addition to that, a given value (can be a constant value, the return value of a function or a variable) is added, right behind the string.

Prototype

```
__api__ int Report1(const char * sMsg, int v);
```

5.11.2.5 JTAG_SetDeviceId()

Description

Sets the JTAG ID of a specified device, in the JTAG chain. The index of the device depends on its position in the JTAG chain. The device closest to TDO has index 0. The Id is used by the DLL to recognize the device.

Before calling this function, please make sure that the JTAG chain has been configured correctly by setting the appropriate global DLL variables. For more information about the known global DLL variables, please refer to *Global DLL variables* on page 223.

Prototype

```
__api__ int JTAG_SetDeviceId(int DeviceIndex, unsigned int Id);
```

5.11.2.6 JTAG_GetDeviceId()

Description

Retrieves the JTAG ID of a specified device, in the JTAG chain. The index of the device depends on its position in the JTAG chain. The device closest to TDO has index 0.

Prototype

```
__api__ int JTAG_GetDeviceId(int DeviceIndex);
```

5.11.2.7 JTAG_WriteIR()**Description**

Writes a JTAG instruction.

Before calling this function, please make sure that the JTAG chain has been configured correctly by setting the appropriate global DLL variables. For more information about the known global DLL variables, please refer to *Global DLL variables* on page 223.

Prototype

```
__api__ int JTAG_WriteIR(unsigned int Cmd);
```

5.11.2.8 JTAG_StoreIR()**Description**

Stores a JTAG instruction in the DLL JTAG buffer.

Before calling this function, please make sure that the JTAG chain has been configured correctly by setting the appropriate global DLL variables. For more information about the known global DLL variables, please refer to *Global DLL variables* on page 223.

Prototype

```
__api__ int JTAG_StoreIR(unsigned int Cmd);
```

5.11.2.9 JTAG_WriteDR()**Description**

Writes JTAG data.

Before calling this function, please make sure that the JTAG chain has been configured correctly by setting the appropriate global DLL variables. For more information about the known global DLL variables, please refer to *Global DLL variables* on page 223.

Prototype

```
__api__ int JTAG_WriteDR(unsigned __int64 tdi, int NumBits);
```

5.11.2.10 JTAG_StoreDR()**Description**

Stores JTAG data in the DLL JTAG buffer.

Before calling this function, please make sure that the JTAG chain has been configured correctly by setting the appropriate global DLL variables. For more information about the known global DLL variables, please refer to *Global DLL variables* on page 223.

Prototype

```
__api__ int JTAG_StoreDR(unsigned __int64 tdi, int NumBits);
```

5.11.2.11 JTAG_Write()**Description**

Writes a JTAG sequence (max. 64 bits per pin).

Prototype

```
__api__ int JTAG_Write(unsigned __int64 tms, unsigned __int64 tdi, int NumBits);
```

5.11.2.12 JTAG_Store()**Description**

Stores a JTAG sequence (max. 64 bits per pin) in the DLL JTAG buffer.

Prototype

```
__api__ int JTAG_Store(unsigned __int64 tms, unsigned __int64 tdi, int NumBits);
```

5.11.2.13 JTAG_GetU32()**Description**

Gets 32 bits JTAG data, starting at given bit position.

Prototype

```
__api__ int JTAG_GetU32(int BitPos);
```

5.11.2.14 JTAG_WriteClocks()**Description**

Writes a given number of clocks.

Prototype

```
__api__ int JTAG_WriteClocks(int NumClocks);
```

5.11.2.15 JTAG_StoreClocks()**Description**

Stores a given number of clocks in the DLL JTAG buffer.

Prototype

```
__api__ int JTAG_StoreClocks(int NumClocks);
```

5.11.2.16 JTAG_Reset()**Description**

Performs a TAP reset and tries to auto-detect the JTAG chain (Total IRLen, Number of devices). If auto-detection was successful, the global DLL variables which determine the JTAG chain configuration, are set to the correct values. For more information about the known global DLL variables, please refer to *Global DLL variables* on page 223.

Note: This will not work for devices which need some special init (for example to add the core to the JTAG chain), which is lost at a TAP reset.

Prototype

```
__api__ int JTAG_Reset(void);
```

5.11.2.17 SYS_Sleep()**Description**

Waits for a given number of milliseconds. During this time, J-Link does not communicate with the target.

Prototype

```
__api__ int SYS_Sleep(int Delaysms);
```

5.11.2.18 JLINK_CORESIGHT_AddAP()**Description**

Allows the user to manually configure the AP-layout of the device J-Link is connected to. This makes sense on targets on which J-Link can not perform a auto-detection of the APs which are present on the target system. Type can only be a known global J-Link DLL AP constant. For a list of all available constants, please refer to *Global DLL constants* on page 227.

Prototype

```
__api__ int JLINK_CORESIGHT_AddAP(int Index, unsigned int Type);
```

Example

```
JLINK_CORESIGHT_AddAP(0, CORESIGHT_AHB_AP); // First AP is a AHB-AP
JLINK_CORESIGHT_AddAP(1, CORESIGHT_APB_AP); // Second AP is a APB-AP
JLINK_CORESIGHT_AddAP(2, CORESIGHT_JTAG_AP); // Third AP is a JTAG-AP
```

5.11.2.19 JLINK_CORESIGHT_Configure()**Description**

Has to be called once, before using any other `_CORESIGHT_` function that accesses the DAP.

Takes a configuration string to prepare target and J-Link for CoreSight function usage. Configuration string may contain multiple setup parameters that are set. Setup parameters are separated by a semicolon.

At the end of the `JLINK_CORESIGHT_Configure()`, the appropriate target interface switching sequence for the currently active target interface is output, if not disabled via setup parameter.

This function has to be called again, each time the JTAG chain changes (for dynamically changing JTAG chains like those which include a TI ICEPick), in order to setup the JTAG chain again.

For JTAG

The SWD -> JTAG switching sequence is output. This also triggers a TAP reset on the target (TAP controller goes through -> Reset -> Idle state)

The IRPre, DRPre, IRPost, DRPost parameters describe which device inside the JTAG chain is currently selected for communication.

For SWD

The JTAG -> SWD switching sequence is output.

It is also made sure that the "overflow mode enable" bit in the SW-DP CTRL/STAT register is cleared, as in SWD mode J-Link always assumes that overflow detection mode is disabled.

Make sure that this bit is NOT set by accident when writing the SW-DP CTRL/STAT register via the `_CORESIGHT_` functions.

Prototype

```
int JLINK_CORESIGHT_Configure(const char* sConfig);
```

Example

```
if (MAIN_ActiveTIF == JLINK_TIF_JTAG) {
    // Simple setup where we have TDI -> Cortex-M (4-bits IRLen) -> TDO
    JLINK_CORESIGHT_Configure("IRPre=0;DRPre=0;IRPost=0;DRPost=0;IRLenDevice=4");
} else {
    // For SWD, no special setup is needed, just output the switching sequence
    JLINK_CORESIGHT_Configure("");
}
```

```

}
v = JLINK_CORESIGHT_ReadDP(JLINK_CORESIGHT_DP_REG_CTRL_STAT);
Report1("DAP-CtrlStat: " v);
// Complex setup where we have TDI -> ICEPick (6-bits IRLen) -> Cortex-M (4-bits
IRLen) -> TDO
JLINK_CORESIGHT_Configure("IRPre=0;DRPre=0;IRPost=6;DRPost=1;IRLenDevice=4;");
v = JLINK_CORESIGHT_ReadDP(JLINK_CORESIGHT_DP_REG_CTRL_STAT);
Report1("DAP-CtrlStat: " v)

```

Known setup parameters

Parameter	Type	Explanation
IRPre	DecValue	Sum of IRLen of all JTAG devices in the JTAG chain, closer to TDO than the actual one J-Link shall communicate with.
DRPre	DecValue	Number of JTAG devices in the JTAG chain, closer to TDO than the actual one, J-Link shall communicate with.
IRPost	DecValue	Sum of IRLen of all JTAG devices in the JTAG chain, following the actual one, J-Link shall communicate with.
DRPost	DecValue	Number of JTAG devices in the JTAG chain, following the actual one, J-Link shall communicate with.
IRLenDevice	DecValue	IRLen of the actual device, J-Link shall communicate with.
PerformTIFInit	DecValue	0: Do not output switching sequence etc. once JLINK_CORESIGHT_Configure() completes.

5.11.2.20 JLINK_CORESIGHT_ReadAP()

Description

Reads a specific AP register.

For JTAG, makes sure that AP is selected automatically.

Makes sure that actual data is returned, meaning for register read-accesses which usually only return data on the second access, this function performs this automatically, so the user will always see valid data.

Prototype

```
int JLINK_CORESIGHT_ReadAP(unsigned int RegIndex);
```

Example

```
v = JLINK_CORESIGHT_ReadAP(JLINK_CORESIGHT_AP_REG_DATA);
Report1("DATA: " v);
```

5.11.2.21 JLINK_CORESIGHT_ReadDP()

Description

Reads a specific DP register.

For JTAG, makes sure that DP is selected automatically.

Makes sure that actual data is returned, meaning for register read-accesses which usually only return data on the second access, this function performs this automatically, so the user will always see valid data.

Prototype

```
int JLINK_CORESIGHT_ReadDP(unsigned int RegIndex);
```

Example

```
v = JLINK_CORESIGHT_ReadDP(JLINK_CORESIGHT_DP_REG_IDCODE);
Report1("DAP-IDCODE: " v);
```

5.11.2.22 JLINK_CORESIGHT_WriteAP()

Description

Writes a specific AP register.
For JTAG, makes sure that AP is selected automatically.

Prototype

```
int JLINK_CORESIGHT_WriteAP(unsigned int RegIndex, unsigned int Data);
```

Example

```
JLINK_CORESIGHT_WriteAP(JLINK_CORESIGHT_AP_REG_BD1, 0x1E);
```

5.11.2.23 JLINK_CORESIGHT_WriteDP()

Description

Writes a specific DP register.
For JTAG, makes sure that DP is selected automatically.

Prototype

```
int JLINK_CORESIGHT_WriteDP(unsigned int RegIndex, unsigned int Data);
```

Example

```
JLINK_CORESIGHT_WriteDP(JLINK_CORESIGHT_DP_REG_ABORT, 0x1E);
```

5.11.3 Global DLL variables

The script file feature also provides some global variables which are used for DLL configuration. Some of these variables can only be set to some specific values, others can be set to the whole datatype with. In the following all global variables and their value ranges are listed and described.

Note: All global variables are treated as unsigned 32-bit values and are zero-initialized.

Legend

- RO: Variable is read-only
- WO: Variable is write-only
- R/W: Variable is read-write

Variable	Description	R/W
CPU	Pre-selects target CPU J-Link is communicating with. Used in InitTarget() to skip the core auto-detection of J-Link. This variable can only be set to a known global J-Link DLL constant. For a list of all valid values, please refer to <i>Global DLL constants</i> on page 227. Example CPU = ARM926EJS;	WO
JTAG_IRPre	Used for JTAG chain configuration. Sets the number of IR-bits of all devices which are closer to TDO than the one we want to communicate with. Example JTAG_IRPre = 6;	R/W
JTAG_DRPre	Used for JTAG chain configuration. Sets the number of devices which are closer to TDO than the one we want to communicate with. Example JTAG_DRPre = 2;	RO

Table 5.11: Global DLL variables

Variable	Description	R/W
JTAG_IRPost	Used for JTAG chain configuration. Sets the number of IR-bits of all devices which are closer to TDI than the one we want to communicate with. Example JTAG_IRPost = 6;	RO
JTAG_DRPost	Used for JTAG chain configuration. Sets the number of devices which are closer to TDI than the one we want to "communicate with". Example JTAG_DRPost = 0;	RO
JTAG_IRLen	IR-Len (in bits) of the device we want to communicate with. Example JTAG_IRLen = 4;	RO
JTAG_TotalIRLen	Computed automatically, based on the values of JTAG_IRPre, JTAG_DRPre, JTAG_IRPost and JTAG_DRPost. Example v = JTAG_TotalIRLen;	RO
JTAG_AllowTAPReset	En-/Disables auto-JTAG-detection of J-Link. Has to be disabled for devices which need some special init (for example to add the core to the JTAG chain), which is lost at a TAP reset. Allowed values 0 Auto-detection is enabled. 1 Auto-detection is disabled.	WO
JTAG_Speed	Sets the JTAG interface speed. Speed is given in kHz. Example JTAG_Speed = 2000; // 2MHz JTAG speed	R/W
JTAG_ResetPin	Pulls reset pin low / Releases nRST pin. Used to issue a reset of the CPU. Value assigned to reset pin reflects the state. 0 = Low, 1 = high. Example JTAG_ResetPin = 0; SYS_Sleep(5); // Give pin some time to get low JTAG_ResetPin = 1;	WO
JTAG_TRSTPin	Pulls reset pin low / Releases nTRST pin. Used to issue a reset of the debug logic of the CPU. Value assigned to reset pin reflects the state. 0 = Low, 1 = high. Example JTAG_TRSTPin = 0; SYS_Sleep(5); // Give pin some time to get low JTAG_TRSTPin = 1;	WO
JTAG_TCKPin	Pulls TCK pin LOW / HIGH. Value assigned to reset pin reflects the state. 0 = LOW, 1 = HIGH. Example JTAG_TCKPin = 0;	R/W
JTAG_TDIpin	Pulls TDI pin LOW / HIGH. Value assigned to reset pin reflects the state. 0 = LOW, 1 = HIGH. Example JTAG_TDIpin = 0;	R/W
JTAG_TMSpin	Pulls TMS pin LOW / HIGH. Value assigned to reset pin reflects the state. 0 = LOW, 1 = HIGH. Example JTAG_TMSpin = 0;	R/W

Table 5.11: Global DLL variables

Variable	Description	R/W
<code>EMU_ETB_IsPresent</code>	If the connected device has an ETB and you want to use it with J-Link, this variable should be set to 1. Setting this variable in another function as <code>InitEmu()</code> does not have any effect. Example <pre>void InitEmu(void) { EMU_ETB_IsPresent = 1; }</pre>	WO
<code>EMU_ETB_UseETB</code>	Uses ETB instead of RAWTRACE capability of the emulator. Setting this variable in another function as <code>InitEmu()</code> does not have any effect. Example <pre>EMU_ETB_UseETB = 0;</pre>	RO
<code>EMU_ETM_IsPresent</code>	Selects whether an ETM is present on the target or not. Setting this variable in another function as <code>InitEmu()</code> does not have any effect. Example <pre>EMU_ETM_IsPresent= 0;</pre>	R/W
<code>EMU_ETM_UseETM</code>	Uses ETM as trace source. Setting this variable in another function as <code>InitEmu()</code> does not have any effect. Example <pre>EMU_ETM_UseETM = 1;</pre>	WO
<code>EMU_JTAG_DisableHWTransmissions</code>	Disables use of hardware units for JTAG transmissions since this can cause problems on some hardware designs. Example <pre>EMU_JTAG_DisableHWTransmissions = 1;</pre>	WO
<code>CORESIGHT_CoreBaseAddr</code>	Sets base address of core debug component for CoreSight compliant devices. Setting this variable disables the J-Link auto-detection of the core debug component base address. Used on devices where auto-detection of the core debug component base address is not possible due to incorrect CoreSight information. Example <pre>CORESIGHT_CoreBaseAddr = 0x80030000;</pre>	R/W
<code>CORESIGHT_IndexAHBAPToUse</code>	Pre-selects an AP as an AHB-AP that J-Link uses for debug communication (Cortex-M). Setting this variable is necessary for example when debugging multi-core devices where multiple AHB-APs are present (one for each device). This function can only be used if a AP-layout has been configured via <code>JLINK_CORESIGHT_AddAP()</code> . Example <pre>JLINK_CORESIGHT_AddAP(0, CORESIGHT_AHB_AP); JLINK_CORESIGHT_AddAP(1, CORESIGHT_AHB_AP); JLINK_CORESIGHT_AddAP(2, CORESIGHT_APB_AP); // // Use second AP as AHB-AP // for target communication // CORESIGHT_IndexAHBAPToUse = 1;</pre>	WO

Table 5.11: Global DLL variables

Variable	Description	R/W
CORESIGHT_ IndexAPBAPToUse	<p>Pre-selects an AP as an APB-AP that J-Link uses for debug communication (Cortex-A/R). Setting this variable is necessary for example when debugging multi-core devices where multiple APB-APs are present (one for each device). This function can only be used if an AP-layout has been configured via <code>JLINK_CORESIGHT_AddAP()</code>.</p> <p>Example</p> <pre>JLINK_CORESIGHT_AddAP(0, CORESIGHT_AHB_AP); JLINK_CORESIGHT_AddAP(1, CORESIGHT_APB_AP); JLINK_CORESIGHT_AddAP(2, CORESIGHT_APB_AP); // // Use third AP as APB-AP // for target communication // CORESIGHT_IndexAPBAPToUse = 2;</pre>	WO
CORESIGHT_ AHBAPCSWDefaultSettings	<p>Overrides the default settings to be used by the DLL when configuring the AHB-AP CSW register. By default, the J-Link DLL will use the following settings for the CSW:</p> <p>Cortex-M0, M0+, M3, M4</p> <pre>[30] == 0 [28] == 0 [27] == 0 [26] == 0 [25] == 1 [24] == 1</pre> <p>Configurable settings</p> <pre>[30] == SPROT: 0 == secure transfer request [28] == HRPOT[4]: Always 0 [27] == HRPOT[3]: 0 == uncachable [26] == HRPOT[2]: 0 == unbufferable [25] == HRPOT[1]: 0 == unprivileged [24] == HRPOT[0]: 1 == Data access</pre>	WO

Table 5.11: Global DLL variables

Variable	Description	R/W
MAIN_ResetType	Used to determine what reset type is currently selected by the debugger. This is useful, if the script has to behave differently in case a specific reset type is selected by the debugger and the script file has a <code>ResetTarget()</code> function which overrides the J-Link reset strategies. Example <pre>if (MAIN_ResetType == 2) { [...] } else { [...] }</pre>	RO
MAIN_ActiveTIF	Returns the currently used target interface used by the DLL to communicate with the target. Useful in cases where some special setup only needs to be done for a certain target interface, e.g. JTAG. For a list of possible values this variable may hold, please refer to <i>Constants for global variable "MAIN_ActiveTIF"</i> on page 228.	RO
MAIN_IsFirstIdentify	Used to check if this is the first time we are running into <code>InitTarget()</code> . Useful if some init steps only need to be executed once per debug session. Example <pre>if (MAIN_IsFirstIdentify == 1) { [...] } else { [...] }</pre>	RO

Table 5.11: Global DLL variables

5.11.4 Global DLL constants

Currently there are only global DLL constants to set the global DLL variable `CPU`. If necessary, more constants will be implemented in the future.

5.11.4.1 Constants for global variable: CPU

The following constants can be used to set the global DLL variable `CPU`:

- ARM7
- ARM7TDMI
- ARM7TDMIR3
- ARM7TDMIR4
- ARM7TDMIS
- ARM7TDMISR3
- ARM7TDMISR4
- ARM9
- ARM9TDMIS
- ARM920T
- ARM922T
- ARM926EJS
- ARM946EJS
- ARM966ES
- ARM968ES
- ARM11
- ARM1136
- ARM1136J
- ARM1136JS
- ARM1136JF
- ARM1136JFS

- ARM1156
- ARM1176
- ARM1176J
- ARM1176JS
- ARM1176IF
- ARM1176JFS
- CORTEX_M0
- CORTEX_M1
- CORTEX_M3
- CORTEX_M3R1P0
- CORTEX_M3R1P1
- CORTEX_M3R2P0
- CORTEX_M4
- CORTEX_M7
- CORTEX_A5
- CORTEX_A7
- CORTEX_A8
- CORTEX_A9
- CORTEX_A12
- CORTEX_A15
- CORTEX_A17
- CORTEX_R4
- CORTEX_R5

5.11.4.2 Constants for "JLINK_CORESIGHT_xxx" functions

APs

- CORESIGHT_AHB_AP
- CORESIGHT_APB_AP
- CORESIGHT_JTAG_AP
- CORESIGHT_CUSTOM_AP

DP/AP register indexes

- JLINK_CORESIGHT_DP_REG_IDCODE
- JLINK_CORESIGHT_DP_REG_ABORT
- JLINK_CORESIGHT_DP_REG_CTRL_STAT
- JLINK_CORESIGHT_DP_REG_SELECT
- JLINK_CORESIGHT_DP_REG_RDBUF
- JLINK_CORESIGHT_AP_REG_CTRL
- JLINK_CORESIGHT_AP_REG_ADDR
- JLINK_CORESIGHT_AP_REG_DATA
- JLINK_CORESIGHT_AP_REG_BD0
- JLINK_CORESIGHT_AP_REG_BD1
- JLINK_CORESIGHT_AP_REG_BD2
- JLINK_CORESIGHT_AP_REG_BD3
- JLINK_CORESIGHT_AP_REG_ROM
- JLINK_CORESIGHT_AP_REG_IDR

5.11.4.3 Constants for global variable "MAIN_ActiveTIF"

- JLINK_TIF_JTAG
- JLINK_TIF_SWD

5.11.5 Script file language

The syntax of the J-Link script file language follows the conventions of the C-language, but it does not support all expressions and operators which are supported by the C-language. In the following, the supported operators and expressions are listed.

5.11.5.1 Supported Operators

The following operators are supported by the J-Link script file language:

- Multiplicative operators: *, /, %
- Additive operators: +, -
- Bitwise shift operators: <<, >>)
- Relational operators: <, >, <=, >=
- Equality operators: ==, !=
- Bitwise operators: &, |, ^
- Logical operators: &&, ||
- Assignment operators: =, *=, /=, +=, -=, <<=, >>=, &=, ^=, |=

5.11.5.2 Supported type specifiers

The following type specifiers are supported by the J-Link script file language:

- void
- char
- int (32-bit)
- __int64

5.11.5.3 Supported type qualifiers

The following type qualifiers are supported by the J-Link script file language:

- const
- signed
- unsigned

5.11.5.4 Supported declarators

The following type qualifiers are supported by the J-Link script file language:

- Array declarators

5.11.5.5 Supported selection statements

The following selection statements are supported by the J-Link script file language:

- if-statements
- if-else-statements

5.11.5.6 Supported iteration statements

The following iteration statements are supported by the J-Link script file language:

- while
- do-while

5.11.5.7 Jump statements

The following jump statements are supported by the J-Link script file language:

- return

5.11.5.8 Sample script files

The J-Link software and documentation package comes with sample script files for different devices. The sample script files can be found at `$JLINK_INST_DIR$\Samples\JLink\Scripts`.

5.11.6 Script file writing example

In the following, a short example of how a J-Link script file could look like. In this example we assume a JTAG chain with two devices on it (Cortex-A8 4 bits IRLen, custom device 5-bits IRLen).

```

void InitTarget(void) {
    Report("J-Link script example.");
    JTAG_Reset(); // Perform TAP reset and J-Link JTAG auto-detection
    if (JTAG_TotalIRLen != 9) { // Basic check if JTAG chain information matches
        MessageBox("Can not find xxx device");
        return 1;
    }
    JTAG_DRPre = 0; // Cortex-A8 is closest to TDO, no no pre devices
    JTAG_DRPost = 1; // 1 device (custom device) comes after the Cortex-A8
    JTAG_IRPre = 0; // Cortex-A8 is closest to TDO, no no pre IR bits
    JTAG_IRPost = 5; // custom device after Cortex-A8 has 5 bits IR len
    JTAG_IRLen = 4; // We selected the Cortex-A8, it has 4 bits IRLen
    CPU = CORTEX_A8; // We are connected to a Cortex-A8
    JTAG_AllowTAPReset = 1; // We are allowed to enter JTAG TAP reset
    //
    // We have a non-CoreSight compliant Cortex-A8 here
    // which does not allow auto-detection of the Core debug components base address.
    // so set it manually to overwrite the DLL auto-detection
    //
    CORESIGHT_CoreBaseAddr = 0x80030000;
}

```

5.11.7 Executing J-Link script files

5.11.7.1 In J-Link commander

When J-Link commander is started it searches for a script file called `Default.JLinkScript` in the folder which contains the `JLink.exe` and the J-Link DLL (by default the installation folder e.g. "C:\Program Files\SEGGER\JLinkARM_V456\"). If this file is found, it is executed instead of the standard auto detection of J-Link. If this file is not present, J-Link commander behaves as before and the normal auto-detection is performed.

5.11.7.2 In Keil MDK-ARM

Keil MDK-ARM does not provide any native support for J-Link script files so usage of them cannot be configured from within the GUI of the IDE itself. Anyhow, it is possible to use a J-Link script file by making use of the auto-search feature of the DLL:

- Navigate to the folder where the uVision project (*.uvproj, *.uvprojx) is located that shall use the script file.

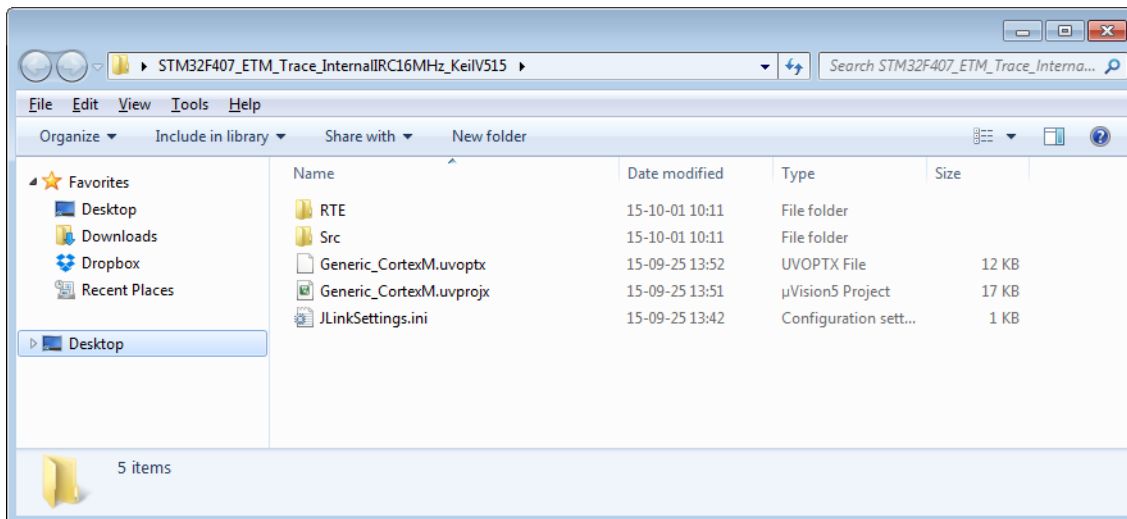

- Copy the J-Link script file to there

- Rename the J-Link script to JLinkSettings.JLinkScript

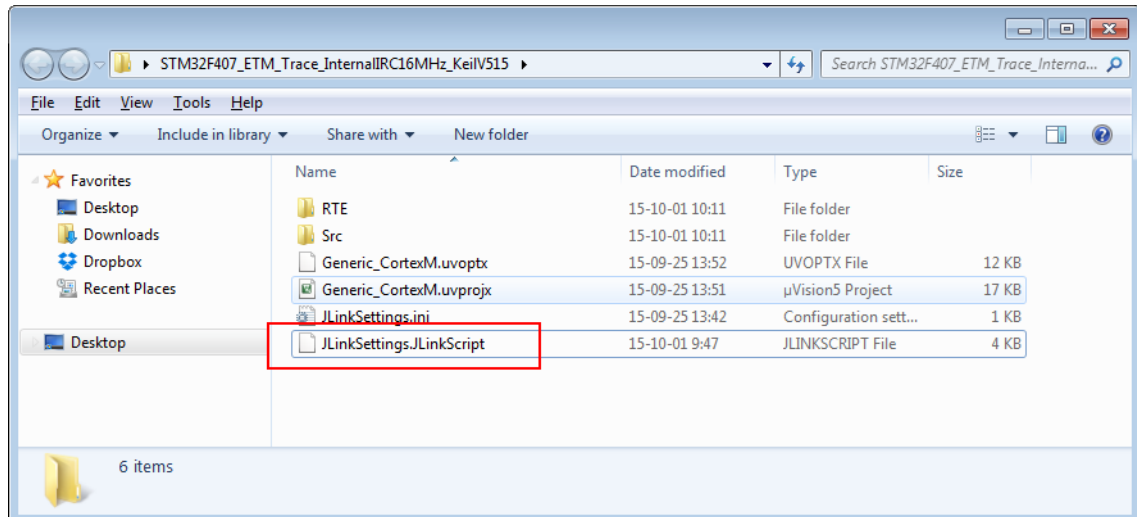

The JLinkSettings.ini is a settings file created by the J-Link DLL on debug session start. If no script file is explicitly passed to the DLL, it will search in the directory of the JLinkSettings.ini for a script file named like the settings file only with a different file extension.

5.11.7.3 In IAR EWARM

IAR EWARM does not provide any native support for J-Link script files so usage of them cannot be configured from within the GUI of the IDE itself. Anyhow, it is possible to use a J-Link script file by making use of the auto-search feature of the DLL:

- Navigate to the folder where the EWARM project (*.ewp) is located
- On the start of the first debug session EWARM will create a `settings` folder there
- Navigate into this settings folder
- There will be a *.jlink file in this folder for each debug configuration of the current project (e.g. Debug + Release)
- Copy the J-Link script file into this folder
- Rename the J-Link script to *.JLinkScript where * is the same name as the *.jlink file has. Example:
MyProject_Debug.jlink
=> Rename J-Link script file to MyProject_Debug.JLinkScript
- On debug session start, the J-Link DLL will search for a *.JLinkScript file with the same name as the J-Link settings file (*.jlink) and if present, the J-Link script file will be used for this session. For more information about how EWARM names the J-Link settings file, please refer to *The J-Link settings file* on page 215.

5.11.7.4 In other debugger IDE environments

To execute a J-Link script file out of your debugger IDE, simply select the script file to execute in the Settings tab of the J-Link control panel and click the save button (after the debug session has been started). Usually a project file for J-Link is set by the debugger, which allows the J-Link DLL to save the settings of the control panel in this project file. After selecting the script file restart your debug session. From now on, the script file will be executed when starting the debug session.

5.11.7.5 In GDB Server

In order to execute a script file when using J-Link GDB Server, simply start the GDB Server, using the following command line parameter:

```
-scriptfile <file>
```

For more information about the `-scriptfile` command line parameter, please refer to *J-Link GDB Server* on page 104.

5.12 Command strings

The behavior of the J-Link can be customized via command strings passed to the `JLinkARM.dll` which controls J-Link. Applications such as the J-Link Commander, but also the C-SPY debugger which is part of the IAR Embedded Workbench, allow passing one or more command strings. Command line strings can be used for passing commands to J-Link (such as switching on target power supply), as well as customize the behavior (by defining memory regions and other things) of J-Link. The use of command strings enables options which can not be set with the configuration dialog box provided by C-SPY.

5.12.1 List of available commands

The table below lists and describes the available command strings.

Command	Description
<code>AppendToLogFile</code>	Enables/Disables always appending new loginfo to log-file.
<code>CORESIGHT_SetIndexAHBAPToUse</code>	Selects a specific AHB-AP to be used to connect to a Cortex-M device.
<code>CORESIGHT_SetIndexAPBAPToUse</code>	Selects a specific APB-AP to be used to connect to a Cortex-A or Cortex-R device.
<code>device</code>	Selects the target device.
<code>DisableAutoUpdateFW</code>	Disables automatic firmware update.
<code>DisableCortexMXPSRAutoCorrectTBit</code>	Disables auto-correction of XPSR T-bit for Cortex-M devices.
<code>DisableFlashBPs</code>	Disables the FlashBP feature.
<code>DisableFlashDL</code>	Disables the J-Link FlashDL feature.
<code>DisableInfoWinFlashBPs</code>	Disables info window for programming FlashBPs.
<code>DisableInfoWinFlashDL</code>	Disables info window for FlashDL.
<code>DisableMOEHandling</code>	Disables output of additional information about mode of entry in case the target CPU is halted / entered debug mode.
<code>DisablePowerSupplyOnClose</code>	Disables power supply on close.
<code>EnableAutoUpdateFW</code>	Enables automatic firmware update.
<code>EnableEraseAllFlashBanks</code>	Enables erase for all accessible flash banks.
<code>EnableFlashBPs</code>	Enables the FlashBP feature.
<code>EnableFlashDL</code>	Enables the J-Link FlashDL feature.
<code>EnableInfoWinFlashBPs</code>	Enables info window for programming FlashBPs.
<code>EnableInfoWinFlashDL</code>	Enables info window for FlashDL.
<code>EnableMOEHandling</code>	Enables output of additional information about mode of entry in case the target CPU is halted / entered debug mode.
<code>EnableRemarks</code>	Enable detailed output during CPU-detection / connection process.
<code>ExcludeFlashCacheRange</code>	Invalidate flash ranges in flash cache, that are configured to be excluded from flash cache.
<code>Hide device selection</code>	Hide device selection dialog.
<code>HSSLogFile</code>	Logs all HSS-Data to file, regardless of the application using HSS.
<code>InvalidateCache</code>	Invalidates Cache.
<code>InvalidateFW</code>	Invalidating current firmware.
<code>map exclude</code>	Ignores all memory accesses to specified area.

Table 5.12: Available command strings

Command	Description
<code>map indirectread</code>	Specifies an area which should be read indirect.
<code>map illegal</code>	Marks a specified memory region as an illegal memory area. Memory accesses to this region are ignored.
<code>map ram</code>	Specifies location of target RAM.
<code>map region</code>	Specifies a memory region.
<code>map reset</code>	Restores the default mapping, which means all memory accesses are permitted.
<code>ProjectFile</code>	Specifies a file or directory which should be used by the J-Link DLL to save the current configuration.
<code>ScriptFile</code>	Set script file path.
<code>SelectTraceSource</code>	Selects which trace source should be used for tracing.
<code>SetAllowFlashCache</code>	Enables/Disables flash cache usage.
<code>SetAllowSimulation</code>	Enables/Disables instruction set simulation.
<code>SetBatchMode</code>	Enables/Disables batch mode.
<code>SetCFIFlash</code>	Specifies CFI flash area.
<code>SetCheckModeAfterRead</code>	Enables/Disables CPSR check after read operations.
<code>SetCompareMode</code>	Specifies the compare mode to be used.
<code>SetCPUConnectIDCODE</code>	Specifies an CPU IDCODE that is used to authenticate the debug probe, when connecting to the CPU.
<code>SetDbgPowerDownOnClose</code>	Used to power-down the debug unit of the target CPU when the debug session is closed.
<code>SetETBIsPresent</code>	Selects if the connected device has an ETB.
<code>SetETMIsPresent</code>	Selects if the connected device has an ETM.
<code>SetFlashDLNoRMWThreshold</code>	Specifies a threshold when writing to flash memory does not cause a read-modify-write operation.
<code>SetFlashDLThreshold</code>	Set minimum amount of data to be downloaded.
<code>SetIgnoreReadMemErrors</code>	Specifies if read memory errors will be ignored.
<code>SetIgnoreWriteMemErrors</code>	Specifies if write memory errors will be ignored.
<code>SetMonModeDebug</code>	Enables/Disables monitor mode debugging.
<code>SetResetPulseLen</code>	Defines the length of the RESET pulse in milliseconds.
<code>SetResetType</code>	Selects the reset strategy.
<code>SetRestartOnClose</code>	Specifies restart behavior on close.
<code>SetRTTAddr</code>	Set address of the RTT buffer.
<code>SetRTTTelnetPort</code>	Set the port used for RTT telnet.
<code>SetRTTSearchRanges</code>	Set ranges to be searched for RTT buffer.
<code>SetRXIDCode</code>	Specifies an ID Code for Renesas RX devices to be used by the J-Link DLL.
<code>SetSkipProgOnCRCMatch</code>	Specifies the CRC match / compare mode to be used. Deprecated, use <code>SetCompareMode</code> instead.
<code>SetSysPowerDownOnIdle</code>	Used to power-down the target CPU, when there are no transmissions between J-Link and target CPU, for a specified timeframe.
<code>SetVerifyDownload</code>	Specifies the verify option to be used.
<code>SetWorkRAM</code>	Specifies RAM area to be used by the J-Link DLL.
<code>ShowControlPanel</code>	Opens control panel.
<code>SilentUpdateFW</code>	Update new firmware automatically.
<code>SupplyPower</code>	Activates/Deactivates power supply over pin 19 of the JTAG connector.
<code>SupplyPowerDefault</code>	Activates/Deactivates power supply over pin 19 of the JTAG connector permanently.

Table 5.12: Available command strings

Command	Description
SuppressControlPanel	Suppress pop up of the control panel.
SuppressInfoUpdateFW	Suppress information regarding firmware updates.
SWOSetConversionMode	Set SWO Conversion mode.

Table 5.12: Available command strings

5.12.1.1 AppendToLogFile

This command can be used to configure the AppendToLogFile feature. If enabled, new log data will always be appended to an existing logfile. Otherwise, each time a new connection will be opened, existing log data will be overwritten. By default new log data will not be always appended to an existing logfile.

Syntax

```
AppendToLogFile = 0 | 1
```

Example

```
AppendToLogFile 1 // Enables AppendToLogFile
```

5.12.1.2 CORESIGHT_SetIndexAHBAPToUse

This command is used to select a specific AHB-AP to be used when connected to an ARM Cortex-M device. Usually, it is not necessary to explicitly select an AHB-AP to be used, as J-Link auto-detects the AP automatically. For multi-core systems with multiple AHB-APs it might be necessary.

The index selected here is an absolute index. For example, if the connected target provides the following AP layout:

- AP[0]: AHB-AP
- AP[1]: APB-AP
- AP[2]: AHB-AP
- AP[3]: JTAG-AP

In order to select the second AHB-AP to be used, use "2" as index.

Syntax

```
CORESIGHT_SetIndexAHBAPToUse = <Index>
```

Example

```
CORESIGHT_SetIndexAHBAPToUse = 2
```

5.12.1.3 CORESIGHT_SetIndexAPBAPToUse

This command is used to select a specific APB-AP to be used when connected to an ARM Cortex-A or Cortex-R device. Usually, it is not necessary to explicitly select an AHB-AP to be used, as J-Link auto-detects the AP automatically. For multi-core systems with multiple APB-APs it might be necessary.

The index selected here is an absolute index. For example, if the connected target provides the following AP layout:

- AP[0]: APB-AP
- AP[1]: AHB-AP
- AP[2]: APB-AP
- AP[3]: JTAG-AP

In order to select the second APB-AP to be used, use "2" as index.

Syntax

```
CORESIGHT_SetIndexAPBAPToUse = <Index>
```

Example

```
CORESIGHT_SetIndexAPBAPToUse = 2
```

5.12.1.4 device

This command selects the target device.

Syntax

```
device = <DeviceID>
```

`DeviceID` has to be a valid device identifier. For a list of all available device identifiers please refer to chapter *Supported devices* on page 260.

Example

```
device = AT91SAM7S256
```

5.12.1.5 DisableAutoUpdateFW

This command is used to disable the automatic firmware update if a new firmware is available.

Syntax

```
DisableAutoUpdateFW
```

5.12.1.6 DisableCortexMXPSRAutoCorrectTBit

Usually, the J-Link DLL auto-corrects the T-bit of the XPSR register to 1, for Cortex-M devices. This is because having it set as 0 is an invalid state and would cause several problems during debugging, especially on devices where the erased state of the flash is 0x00 and therefore on empty devices the T-bit in the XPSR would be 0. Anyhow, if for some reason explicit disable of this auto-correction is necessary, this can be achieved via the following command string.

Syntax

```
DisableCortexMXPSRAutoCorrectTBit
```

5.12.1.7 DisableFlashBPs

This command disables the FlashBP feature.

Syntax

```
DisableFlashBPs
```

5.12.1.8 DisableFlashDL

This command disables the J-Link FlashDL feature.

Syntax

```
DisableFlashDL
```

5.12.1.9 DisableInfoWinFlashBPs

This command is used to disable the flash download window for the flash breakpoint feature. Enabled by default.

Syntax

```
DisableInfoWinFlashBPs
```

5.12.1.10 DisableInfoWinFlashDL

This command is used to disable the flash download information window for the flash download feature. Enabled by default.

Syntax

```
DisableInfoWinFlashDL
```

5.12.1.11 DisableMOEHandling

The J-Link DLL outputs additional information about mode of entry (MOE) in case the target CPU halted / entered debug mode. Disabled by default.

Syntax

```
DisableMOEHandling
```

5.12.1.12 DisablePowerSupplyOnClose

This command is used to ensure that the power supply for the target will be disabled on close.

Syntax

```
DisablePowerSupplyOnClose
```

5.12.1.13 EnableAutoUpdateFW

This command is used to enable the automatic firmware update if a new firmware is available.

Syntax

```
EnableAutoUpdateFW
```

5.12.1.14 EnableEraseAllFlashBanks

Used to enable erasing of other flash banks than the internal, like (Q)SPI flash or CFI flash.

Syntax

```
EnableEraseAllFlashBanks
```

5.12.1.15 EnableFlashBPs

This command enables the `FlashBP` feature.

Syntax

```
EnableFlashBPs
```

5.12.1.16 EnableFlashDL

This command enables the J-Link ARM FlashDL feature.

Syntax

```
EnableFlashDL
```

5.12.1.17 EnableInfoWinFlashBPs

This command is used to enable the flash download window for the flash breakpoint feature. Enabled by default.

Syntax

```
EnableInfoWinFlashBPs
```

5.12.1.18 EnableInfoWinFlashDL

This command is used to enable the flash download information window for the flash download feature.

Syntax

```
EnableInfoWinFlashDL
```

5.12.1.19 EnableMOEHandling

The J-Link DLL outputs additional information about mode of entry (MOE) in case the target CPU halted / entered debug mode. Disabled by default.

Additional information is output via log-callback set with

```
JLINK_OpenEx(JLINK_LOG* pfLog, JLINK_LOG* pfErrorOut)
```

Syntax

```
EnableMOEHandling
```

5.12.1.20 EnableRemarks

The J-link DLL provides more detailed output during CPU-detection / connection process. Kind of "verbose" option. Disabled by default, therefore only an enable option. Will be reset to "disabled" on each call to JLINK_Open() (reconnect to J-Link).

Syntax

```
EnableRemarks
```

5.12.1.21 ExcludeFlashCacheRange

This command is used to invalidate flash ranges in flash cache, that are configured to be excluded from the cache.

Example

```
ExcludeFlashCacheRange 0x10000000-0x100FFFFF
```

5.12.1.22 GetCPUVars**5.12.1.23 Hide device selection**

This command can be used to suppress the device selection dialog. If enabled, the device selection dialog will not be shown in case an unknown device is selected.

Syntax

```
HideDeviceSelection = 0 | 1
```

Example

```
HideDeviceSelection 1 // Device selection will not show up
```

5.12.1.24 HSSLogFile

This command enables HSS-Logging. Separate to the application using HSS, all HSS Data will be stored in the specified file.

Syntax

```
HSSLogFile = <Path>
```

Example

```
HSSLogFile = C:\Test.log
```

5.12.1.25 InvalidateCache

This command is used to invalidate cache.

Syntax

InvalidateCache

5.12.1.26 InvalidateFW

This command is used to invalidate the current firmware of the J-Link / J-Trace. Invalidating the firmware will force a firmware update. Can be used for downdating. For more information please refer to *J-Link / J-Trace firmware* on page 446.

Syntax

InvalidateFW

5.12.1.27 map exclude

This command excludes a specified memory region from all memory accesses. All subsequent memory accesses to this memory region are ignored.

Memory mapping

Some devices do not allow access of the entire 4GB memory area. Ideally, the entire memory can be accessed; if a memory access fails, the CPU reports this by switching to abort mode. The CPU memory interface allows halting the CPU via a WAIT signal. On some devices, the WAIT signal stays active when accessing certain unused memory areas. This halts the CPU indefinitely (until RESET) and will therefore end the debug session. This is exactly what happens when accessing critical memory areas. Critical memory areas should not be present in a device; they are typically a hardware design problem. Nevertheless, critical memory areas exist on some devices.

To avoid stalling the debug session, a critical memory area can be excluded from access: J-Link will not try to read or write to critical memory areas and instead ignore the access silently. Some debuggers (such as IAR C-SPY) can try to access memory in such areas by dereferencing non-initialized pointers even if the debugged program (the debuggee) is working perfectly. In situations like this, defining critical memory areas is a good solution.

Syntax

```
map exclude <SAddr>-<EAddr>
```

Example

This is an example for the `map exclude` command in combination with an NXP LPC2148 MCU.

Memory map

0x00000000-0x0007FFFF	On-chip flash memory
0x00080000-0x3FFFFFFF	Reserved
0x40000000-0x40007FFF	On-chip SRAM
0x40008000-0x7FCFFFFFFF	Reserved
0x7FD00000-0x7FD01FFF	On-chip USB DMA RAM
0x7FD02000-0x7FD02000	Reserved
0x7FFFD000-0x7FFFFFFF	Boot block (remapped from on-chip flash memory)
0x80000000-0xDFFFFFFF	Reserved
0xE0000000-0xEFFFFFFF	VPB peripherals
0xF0000000-0xFFFFFFFF	AHB peripherals

The "problematic" memory areas are:

0x00080000-0x3FFFFFFF	Reserved
-----------------------	----------

```
0x40008000-0x7FCFFFFFF    Reserved
0x7FD02000-0x7FD02000    Reserved
0x80000000-0xDFFFFFFF     Reserved
```

To exclude these areas from being accessed through J-Link the `map exclude` command should be used as follows:

```
map exclude 0x00080000-0x3FFFFFFF
map exclude 0x40008000-0x7FCFFFFFFF
map exclude 0x7FD02000-0x7FD02000
map exclude 0x80000000-0xDFFFFFFF
```

5.12.1.28 map illegal

This command marks a specified memory region as an illegal memory area. All subsequent memory accesses to this memory region produces a warning message and the memory access is ignored. This command can be used to mark more than one memory region as an illegal area by subsequent calls.

Syntax

```
Map Illegal <SAddr>--<EAddr>
```

Example

```
Map Illegal 0xF0000000-0xFFDFFFFFFF
```

Additional information

- `SAddr` has to be a 256-byte aligned address.

The region size has to be a multiple of 256 bytes.

5.12.1.29 map indirectread

This command can be used to read a memory area indirectly. Indirect reading means that a small code snippet is downloaded into RAM of the target device, which reads and transfers the data of the specified memory area to the host. Before `map indirectread` can be called a RAM area for the indirect read code snippet has to be defined. Use therefor the `map ram` command and define a RAM area with a size of ≥ 256 byte.

Typical applications

Refer to chapter *Fast GPIO bug* on page 402 for an example.

Syntax

```
map indirectread <StartAddressOfArea>--<EndAddress>
```

Example

```
map indirectread 0x3fffc000-0x3fffcfff
```

Additional information

- `StartAddressOfArea` has to be a 256-byte aligned address.

The region size has to be a multiple of 256 bytes.

5.12.1.30 map ram

This command should be used to define an area in RAM of the target device. The area must be 256-byte aligned. The data which was located in the defined area will not be corrupted. Data which resides in the defined RAM area is saved and will be restored if necessary. This command has to be executed before `map indirectread` will be called.

Typical applications

Refer to chapter *Fast GPIO bug* on page 402 for an example.

Syntax

```
map ram <StartAddressOfArea>-<EndAddressOfArea>
```

Example

```
map ram 0x40000000-0x40003fff;
```

Additional information

- StartAddressOfArea has to be a 256-byte aligned address.

The region size has to be a multiple of 256 bytes.

5.12.1.31 map region

This command is used to specify memory areas with various region types.

Syntax

```
map region <StartAddressOfArea>-<EndAddressOfArea> <RegionType>
```

Region type	Description
N	Normal
C	Cacheable
X	Excluded
XI	Excluded & Illegal
I	Indirect access
A	Alias (static, e.g. RAM/flash that is aliased multiple times in one area. Does not change during the debug session.)
AD	Alias (dynamic, e.g. memory areas where different memories can be mapped to.)

Example

```
map region 0x100000-0x1FFFFFF C
```

5.12.1.32 map reset

This command restores the default memory mapping, which means all memory accesses are permitted.

Typical applications

Used with other "map" commands to return to the default values. The map reset command should be called before any other "map" command is called.

Syntax

```
map reset
```

Example

```
map reset
```

5.12.1.33 ProjectFile

This command is used to specify a file used by the J-Link DLL to save the current configuration.

Using this command is recommended if settings need to be saved. This is typically the case if Flash breakpoints are enabled and used. It is recommended that an IDE

uses this command to allow the `JLinkARM.dll` to store its settings in the same directory as the project and settings file of the IDE. The recommended extension for project files is `*.jlink`.

Assuming the Project is saved under `C:\Work\Work` and the project contains to targets name `Debug` and `Release`, the debug version could set the file name

```
C:\Work\Work\Debug.jlink.
```

The release version could use

```
C:\Work\Work\Release.jlink.
```

Note

Spaces in the filename are permitted.

Syntax

```
ProjectFile = <FullFileName>
```

Example

```
ProjectFile = C:\Work\Release.jlink
```

5.12.1.34ScriptFile

This command is used to set the path to a J-Link script file which shall be executed. J-Link scriptfiles are mainly used to connect to targets which need a special connection sequence before communication with the core is possible.

Syntax

```
ScriptFile = <FullFileName>
```

Example

```
ScriptFile = C:\Work\Default.JLinkScript
```

5.12.1.35SelectTraceSource

This command selects the trace source which shall be used for tracing.

Syntax

```
SelectTraceSource = <SourceNumber>
```

Trace source number	Description
0	ETB
1	ETM

Example

```
SelectTraceSource = 0 // Select ETB
```

5.12.1.36SetAllowFlashCache

This command is used to enable / disable caching of flash contents. Enabled by default.

Syntax

```
SetAllowFlashCache = 0 | 1
```

Example

```
SetAllowFlashCache = 1 // Enables flash cache
```

5.12.1.37 SetAllowSimulation

This command can be used to enable or disable the instruction set simulation. By default the instruction set simulation is enabled.

Syntax

```
SetAllowSimulation = 0 | 1
```

Example

```
SetAllowSimulation 1 // Enables instruction set simulation
```

5.12.1.38 SetBatchMode

This command is used to tell the J-Link DLL that it is used in batch-mode / automated mode, so some dialogs etc. will automatically close after a given timeout. Disabled by default.

Syntax

```
SetBatchMode = 0 | 1
```

Example

```
SetBatchMode 1 // Enables batch mode
```

5.12.1.39 SetCFIFlash

This command can be used to set a memory area for CFI compliant flashes.

Syntax

```
SetCFIFlash <StartAddressOfArea>-<EndAddressOfArea>
```

Example

```
SetCFIFlash 0x10000000-0x100FFFFFF
```

5.12.1.40 SetCheckModeAfterRead

This command is used to enable or disable the verification of the CPSR (current processor status register) after each read operation. By default this check is enabled. However this can cause problems with some CPUs (e.g. if invalid CPSR values are returned). Please note that if this check is turned off (SetCheckModeAfterRead = 0), the success of read operations cannot be verified anymore and possible data aborts are not recognized.

Typical applications

This verification of the CPSR can cause problems with some CPUs (e.g. if invalid CPSR values are returned). Note that if this check is turned off (SetCheckModeAfterRead = 0), the success of read operations cannot be verified anymore and possible data aborts are not recognized.

Syntax

```
SetCheckModeAfterRead = 0 | 1
```

Example

```
SetCheckModeAfterRead = 0
```

5.12.1.41 SetCompareMode

This command is used to configure the compare mode.

Syntax

```
SetCompareMode = <Mode>
```

Compare mode	Description
0	Skip
1	Using fastest method (default)
2	Using CRC
3	Using readback

Example

```
SetCompareMode = 1 // Select using fastest method
```

5.12.1.42 SetCPUConnectIDCODE

Used to specify an IDCODE that is used by J-Link to authenticate itself when connecting to a specific device. Some devices allow the user to lock out a debugger by default, until a specific unlock code is provided that allows further debugging. This function allows to automate this process, if J-Link is used in a production environment.

The IDCODE stream is expected as a hex-encoded byte stream. If the CPU e.g. works on a word-basis for the IDCODE, this stream is interpreted as a little endian formatted stream where the J-Link library then loads the words from and passes them to the device during connect.

Syntax

```
SetCPUConnectIDCODE = <IDCODE_Stream>
```

Example

CPU has a 64-bit IDCODE (on word-basis) and expects 0x11223344 0x55667788 as IDCODE.

```
SetCPUConnectIDCODE = 4433221188776655
```

5.12.1.43 SetDbgPowerDownOnClose

When using this command, the debug unit of the target CPU is powered-down when the debug session is closed.

Note: This command works only for Cortex-M3 devices

Typical applications

This feature is useful to reduce the power consumption of the CPU when no debug session is active.

Syntax

```
SetDbgPowerDownOnClose = <value>
```

Example

```
SetDbgPowerDownOnClose = 1 // Enables debug power-down on close.
SetDbgPowerDownOnClose = 0 // Disables debug power-down on close.
```

5.12.1.44 SetETBIsPresent

This command is used to select if the connected device has an ETB.

Syntax

```
SetETBIsPresent = 0 | 1
```

Example

```
SetETBIsPresent = 1 // ETB is available
SetETBIsPresent = 0 // ETB is not available
```

5.12.1.45 SetETMIsPresent

This command is used to select if the connected device has an ETM.

Syntax

```
SetETMIsPresent = 0 | 1
```

Example

```
SetETMIsPresent = 1 // ETM is available
SetETMIsPresent = 0 // ETM is not available
```

5.12.1.46 SetFlashDLNoRMWThreshold

This command sets the J-Link DLL internal threshold when a write to flash memory does not cause a read-modify-write (RMW) operation. For example, when setting this value to 0x800, all writes of amounts of data < 2 KB will cause the DLL to perform a read-modify-write operation on incomplete sectors.

Default: Writing amounts of < 1 KB (0x400) to flash causes J-Link to perform a read-modify-write on the flash.

Example 1 with default config:

Flash has 2 * 1 KB sectors

Debugger writes 512 bytes

J-Link will perform a read-modify-write on the first sector, preserving contents of 512-1023 bytes. Second sector is left untouched.

Example 2 with default config:

Flash has 2 * 1 KB sectors

Debugger writes 1280 bytes

J-Link will erase + program 1 KB of first sector.

J-Link will erase + program 256 bytes of second sector. Previous 768 bytes from second sector are lost.

The default makes sense for flash programming where old contents in remaining space of affected sectors are usually not needed anymore. Writes of < 1 KB usually mean that the user is performing flash manipulation from within a memory window in a debugger to manipulate the application behavior during runtime (e.g. by writing some constant data used by the application). In such cases, it is important to preserve the remaining data in the sector to allow the application to further work correctly.

Syntax

```
SetFlashDLNoRMWThreshold = <value>
```

Example

```
SetFlashDLNoRMWThreshold = 0x100 // 256 Bytes
```

5.12.1.47 SetFlashDLThreshold

This command is used to set a minimum amount of data to be downloaded by the flash download feature.

Syntax

```
SetFlashDLThreshold = <value>
```

Example

```
SetFlashDLThreshold = 0x100 // 256 Bytes
```

5.12.1.48 SetIgnoreReadMemErrors

This command can be used to ignore read memory errors. Disabled by default.

Syntax

```
SetIgnoreReadMemErrors = 0 | 1
```

Example

```
SetIgnoreReadMemErrors = 1 // Read memory errors will be ignored  
SetIgnoreReadMemErrors = 0 // Read memory errors will be reported
```

5.12.1.49 SetIgnoreWriteMemErrors

This command can be used to ignore read memory errors. Disabled by default.

Syntax

```
SetIgnoreWriteMemErrors = 0 | 1
```

Example

```
SetIgnoreWriteMemErrors = 1 // Write memory errors will be ignored  
SetIgnoreWriteMemErrors = 0 // Write memory errors will be reported
```

5.12.1.50 SetMonModeDebug

This command is used to enable / disable monitor mode debugging. Disabled by default.

Syntax

```
SetMonModeDebug = 0 | 1
```

Example

```
SetMonModeDebug = 1 // Monitor mode debugging is enabled  
SetMonModeDebug = 0 // Monitor mode debugging is disabled
```

5.12.1.51 SetResetPulseLen

This command defines the length of the RESET pulse in milliseconds. The default for the RESET pulse length is 20 milliseconds.

Syntax

```
SetResetPulseLen = <value>
```

Example

```
SetResetPulseLen = 50
```

5.12.1.52 SetResetType

This command selects the reset strategy which shall be used by J-Link, to reset the device. The value which is used for this command is analog to the reset type which shall be selected. For a list of all reset types which are available, please refer to *Reset strategies* on page 209. Please note that there different reset strategies for ARM 7/9 and Cortex-M devices.

Syntax

```
SetResetType = <value>
```

Example

```
SetResetType = 0 // Selects reset strategy type 0: normal
```

5.12.1.53 SetRestartOnClose

This command specifies whether the J-Link restarts target execution on close. The default is to restart target execution. This can be disabled by using this command.

Syntax

```
SetRestartOnClose = 0 | 1
```

Example

```
SetRestartOnClose = 1
```

5.12.1.54 SetRTTAddr

In some cases J-Link cannot locate the RTT buffer in known RAM. This command is used to set the exact address manually.

Syntax

```
SetRTTAddr <RangeStart>
```

Example

```
SetRTTAddr 0x20000000
```

5.12.1.55 SetRTTTelnetPort

This command alters the RTT telnet port. Default is 19021.

This command must be called before a connection to a J-Link is established.

In J-Link Commander, command strings ("exec <CommandString>") can only be executed after a connection to J-Link is established, therefore this command string has no effect in J-Link Commander. The `-RTTTelnetPort` command line parameter can be used instead .

Syntax

```
SetRTTTelnetPort <value>
```

Example

```
SetRTTTelnetPort 9100
```

5.12.1.56 SetRTTSearchRanges

In some cases J-Link cannot locate the RTT buffer in known RAM. This command is used to set (multiple) ranges to be searched for the RTT buffer.

Syntax

```
SetRTTSearchRanges <RangeAddr> <RangeSize> [, <RangeAddr1> <RangeSize1>, ..]
```

Example

```
SetRTTSearchRanges 0x10000000 0x1000, 0x20000000 0x1000,
```

5.12.1.57 SetRXIDCode

This command is used to set the ID Code for Renesas RX devices to be used by the J-Link DLL.

Syntax

```
SetRXIDCode = <RXIDCode_String>
```

Example

Set 16 IDCode Bytes (32 Characters).

```
SetRXIDCode = 112233445566778899AABBCCDDEEFF00
```

5.12.1.58 SetSkipProgOnCRCMatch

Note: Deprecated. Use [SetCompareMode](#) instead.

This command is used to configure the CRC match / compare mode.

Syntax

```
SetSkipProgOnCRCMatch = <CompareMode>
```

Compare mode	Description
0	Skip
1	Using fastest method (default)
2	Using CRC
3	Using readback

Example

```
SetSkipProgOnCRCMatch = 1 // Select using fastest method
```

5.12.1.59 SetSysPowerDownOnIdle

When using this command, the target CPU is powered-down when no transmission between J-Link and the target CPU was performed for a specific time. When the next command is given, the CPU is powered-up.

Note: This command works only for Cortex-M3 devices.

Typical applications

This feature is useful to reduce the power consumption of the CPU.

Syntax

```
SetSysPowerDownOnIdle = <value>
```

Note: A 0 for <value> disables the power-down on idle functionality.

Example

```
SetSysPowerDownOnIdle = 10; // The target CPU is powered-down when there is no
                             // transmission between J-Link and target CPU for at least
10ms
```

5.12.1.60 SetVerifyDownload

This command is used to configure the verify mode.

Syntax

```
SetVerifyDownload = <VerifyMode>
```

Verify mode	Description
0	Skip
1	Programmed sectors, fastest method (default)
2	Programmed sectors using CRC
3	Programmed sectors using readback
4	All sectors using fastest method
5	All sectors using CRC

Verify mode	Description
6	All sectors using read back
7	Programmed sectors using checksum
8	All sectors using checksum

Example

```
SetVerifyDownload = 1 // Select programmed sectors, fastest method
```

5.12.1.61 SetWorkRAM

This command can be used to configure the RAM area which will be used by J-Link.

Syntax

```
SetWorkRAM <StartAddressOfArea>-<EndAddressOfArea>
```

Example

```
SetWorkRAM 0x10000000-0x100FFFFFF
```

5.12.1.62 ShowControlPanel

Executing this command opens the control panel.

Syntax

```
ShowControlPanel
```

5.12.1.63 SilentUpdateFW

After using this command, new firmware will be updated automatically without opening a message box.

Syntax

```
SilentUpdateFW
```

5.12.1.64 SupplyPower

This command activates power supply over pin 19 of the JTAG connector. The KS (Kickstart) versions of J-Link have the V5 supply over pin 19 activated by default.

Typical applications

This feature is useful for some eval boards that can be powered over the JTAG connector.

Syntax

```
SupplyPower = 0 | 1
```

Example

```
SupplyPower = 1
```

5.12.1.65 SupplyPowerDefault

This command activates power supply over pin 19 of the JTAG connector permanently. The KS (Kickstart) versions of J-Link have the V5 supply over pin 19 activated by default.

Typical applications

This feature is useful for some eval boards that can be powered over the JTAG connector.

Syntax

```
SupplyPowerDefault = 0 | 1
```

Example

```
SupplyPowerDefault = 1
```

5.12.1.66 SuppressControlPanel

Using this command ensures, that the control panel will not pop up automatically.

Syntax

```
SuppressControlPanel
```

5.12.1.67 SuppressInfoUpdateFW

After using this command information about available firmware updates will be suppressed.

Note: We strongly recommend not to use this command, latest firmware versions should always be used!

Syntax

```
SuppressInfoUpdateFW
```

5.12.1.68 SWOSetConversionMode

This command is used to set the SWO conversion mode.

Syntax

```
SWOSetConversionMode = <ConversionMode>
```

Conversion mode	Description
0	If only '\n' is received, make it "\r\n" to make the line end Windows-compliant. (Default behavior)
1	Leave everything as it is, do not add any characters.

Example

```
SWOSetConversionMode = 0
```

5.12.2 Using command strings

5.12.2.1 J-Link Commander

The J-Link command strings can be tested with the J-Link Commander. Use the command `exec` supplemented by one of the command strings.

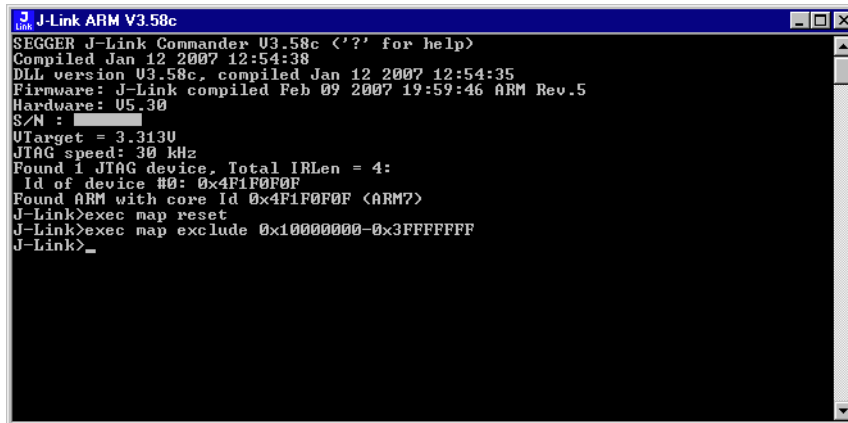

```

J-Link ARM V3.58c
SEGGER J-Link Commander U3.58c ("?" for help)
Compiled Jan 12 2007 12:54:38
DLL version U3.58c, compiled Jan 12 2007 12:54:35
Firmware: J-Link compiled Feb 09 2007 19:59:46 ARM Rev.5
Hardware: U5.30
S/N : [redacted]
VTarget = 3.313U
JTAG speed: 30 kHz
Found 1 JTAG device, Total IRLen = 4:
Id of device #0: 0x4F1F0F0F
Found ARM with core Id 0x4F1F0F0F (ARM7)
J-Link>exec map reset
J-Link>exec map exclude 0x10000000-0x3FFFFFFF
J-Link>_
  
```

Example

```

exec SupplyPower = 1
exec map reset
exec map exclude 0x10000000-0x3FFFFFFF
  
```

5.12.2.2 IAR Embedded Workbench

The J-Link command strings can be supplied using the C-SPY debugger of the IAR Embedded Workbench. Open the **Project options** dialog box and select **Debugger**.

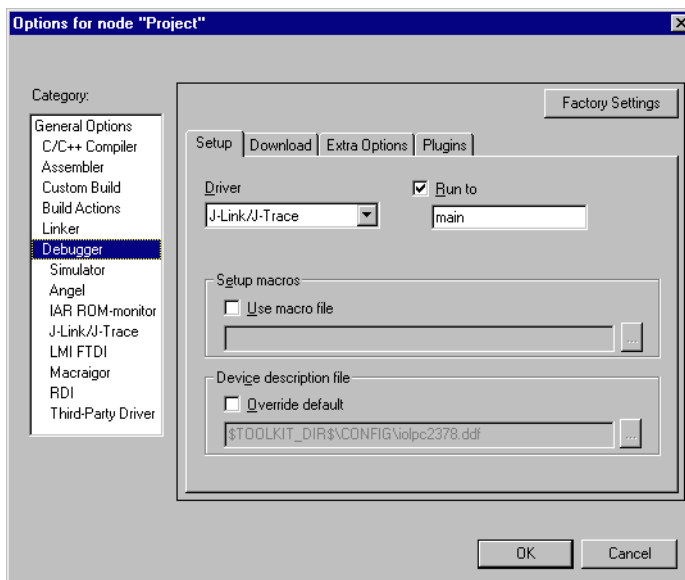

On the **Extra Options** page, select **Use command line options**.

Enter `--jlink_exec_command "<CommandLineOption>"` in the textfield, as shown in the screenshot below. If more than one command should be used separate the commands with semicolon.

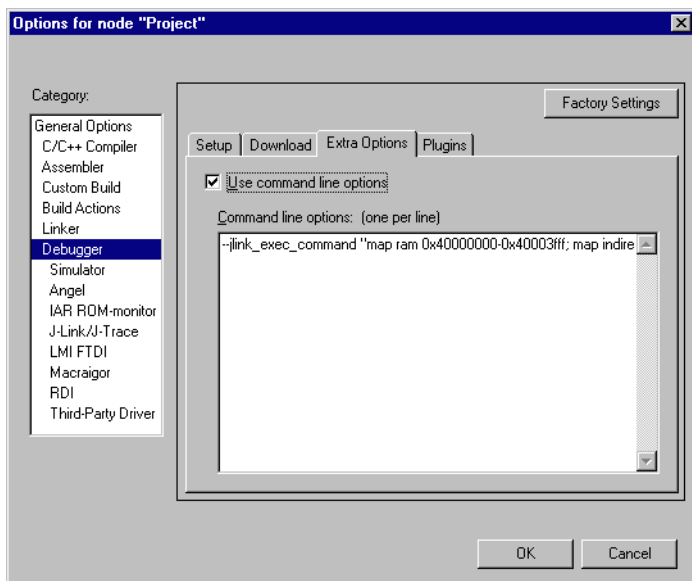

5.13 Switching off CPU clock during debug

We recommend not to switch off CPU clock during debug. However, if you do, you should consider the following:

Non-synthesizable cores (ARM7TDMI, ARM9TDMI, ARM920, etc.)

With these cores, the TAP controller uses the clock signal provided by the emulator, which means the TAP controller and ICE-Breaker continue to be accessible even if the CPU has no clock.

Therefore, switching off CPU clock during debug is normally possible if the CPU clock is periodically (typically using a regular timer interrupt) switched on every few ms for at least a few μ s. In this case, the CPU will stop at the first instruction in the ISR (typically at address 0x18).

Synthesizable cores (ARM7TDMI-S, ARM9E-S, etc.)

With these cores, the clock input of the TAP controller is connected to the output of a three-stage synchronizer, which is fed by clock signal provided by the emulator, which means that the TAP controller and ICE-Breaker are not accessible if the CPU has no clock.

If the RTCK signal is provided, adaptive clocking function can be used to synchronize the JTAG clock (provided by the emulator) to the processor clock. This way, the JTAG clock is stopped if the CPU clock is switched off.

If adaptive clocking is used, switching off CPU clock during debug is normally possible if the CPU clock is periodically (typically using a regular timer interrupt) switched on every few ms for at least a few μ s. In this case, the CPU will stop at the first instruction in the ISR (typically at address 0x18).

5.14 Cache handling

Most target systems with external memory have at least one cache. Typically, ARM7 systems with external memory come with a unified cache, which is used for both code and data. Most ARM9 systems with external memory come with separate caches for the instruction bus (I-Cache) and data bus (D-Cache) due to the hardware architecture.

5.14.1 Cache coherency

When debugging or otherwise working with a system with processor with cache, it is important to maintain the cache(s) and main memory coherent. This is easy in systems with a unified cache and becomes increasingly difficult in systems with hardware architecture. A write buffer and a D-Cache configured in write-back mode can further complicate the problem.

ARM9 chips have no hardware to keep the caches coherent, so that this is the responsibility of the software.

5.14.2 Cache clean area

J-Link / J-Trace handles cache cleaning directly through JTAG commands. Unlike other emulators, it does not have to download code to the target system. This makes setting up J-Link / J-Trace easier. Therefore, a cache clean area is not required.

5.14.3 Cache handling of ARM7 cores

Because ARM7 cores have a unified cache, there is no need to handle the caches during debug.

5.14.4 Cache handling of ARM9 cores

ARM9 cores with cache require J-Link / J-Trace to handle the caches during debug. If the processor enters debug state with caches enabled, J-Link / J-Trace does the following:

When entering debug state

J-Link / J-Trace performs the following:

- It stores the current write behavior for the D-Cache.
- It selects write-through behavior for the D-Cache.

When leaving debug state

J-Link / J-Trace performs the following:

- It restores the stored write behavior for the D-Cache.
- It invalidates the D-Cache.

Note: The implementation of the cache handling is different for different cores. However, the cache is handled correctly for all supported ARM9 cores.

5.15 Virtual COM Port (VCOM)

5.15.1 Configuring Virtual COM Port

In general, the VCOM feature can be disabled and enabled for debug probes which comes with support for it via J-Link Commander and J-Link Configurator. Below, a small description of how to use use them to configure the feature is given.

Note: VCOM can only be used when debugging via SWD target interface. Pin 5 = J-Link-Tx (out), Pin 17 = J-Link-Rx (in).

Note: Currently, only J-Link models with hardware version 9 or newer comes with VCOM capabilities.

5.15.1.1 Via J-Link Configurator

The J-Link software and documentation package comes with a free GUI-based utility called J-Link Configurator which auto-detects all J-Links that are connected to the host PC via USB & Ethernet. The J-Link Configurator allows the user to enable and disable the VCOM. For more information about the J-Link Configurator, please refer to *J-Link Configurator* on page 177.

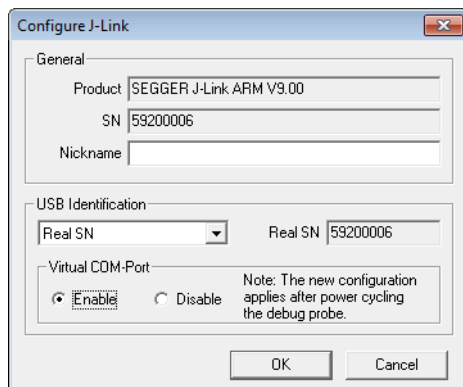

5.15.1.2 Via J-Link Commander

Simply start J-Link Commander, which is part of the J-Link software and documentation package and enter the `vcom enable|disable` command as in the screenshot below. After changing the configuration a power on cycle of the debug probe is necessary in order to use the new configuration. For feature information about how to use the J-Link Commander, please refer to *J-Link Commander (Command line tool)* on page 83.

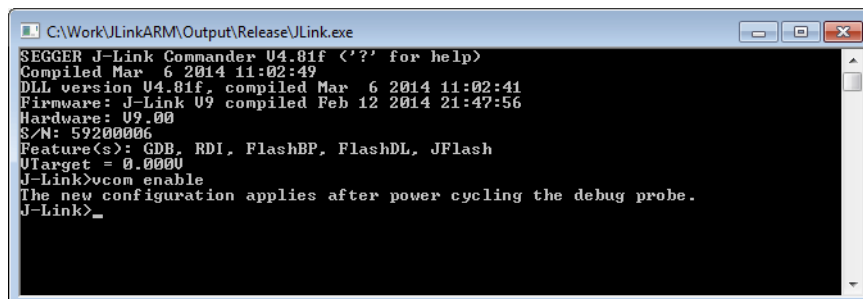

Chapter 6

Flash download

This chapter describes how the flash download feature of the DLL can be used in different debugger environments.

6.1 Introduction

The J-Link DLL comes with a lot of flash loaders that allow direct programming of internal flash memory for popular microcontrollers. Moreover, the J-Link DLL also allows programming of CFI-compliant external NOR flash memory. The flash download feature of the J-Link DLL does not require an extra license and can be used free of charge.

Why should I use the J-Link flash download feature?

Being able to download code directly into flash from the debugger or integrated IDE significantly shortens the turn-around times when testing software. The flash download feature of J-Link is very efficient and allows fast flash programming. For example, if a debugger splits the download image into several pieces, the flash download software will collect the individual parts and perform the actual flash programming right before program execution. This avoids repeated flash programming. . Moreover, the J-Link flash loaders make flash behave like RAM. This means that the debugger only needs to select the correct device which enables the J-Link DLL to automatically activate the correct flash loader if the debugger writes to a specific memory address.

This also makes it very easy for debugger vendors to make use of the flash download feature because almost no extra work is necessary on the debugger side since the debugger does not have to differ between memory writes to RAM and memory writes to flash.

6.2 Licensing

No extra license required. The flash download feature can be used free of charge.

6.3 Supported devices

J-Link supports download into the internal flash of a large number of microcontrollers. You can always find the latest list of supported devices on our website:

http://www.segger.com/jlink_supported_devices.html

In general, J-Link can be used with any ARM7/9/11, Cortex-M0/M1/M3/M4 and Cortex-A5/A8/R4 core even if it does not provide internal flash.

Furthermore, flash download is also available for all CFI-compliant external NOR-flash devices.

6.4 Setup for various debuggers (internal flash)

The J-Link flash download feature can be used by different debuggers, such as IAR Embedded Workbench, Keil MDK, GDB based IDEs, ... For different debuggers there are different steps required to enable J-Link flash download. In this section, the setup for different debuggers is explained.

6.4.1 IAR Embedded Workbench

Using the J-Link flash download feature in IAR EWARM is quite simple:

First, choose the right device in the project settings if not already done. The device settings can be found at **Project->Options->General Options->Target**.

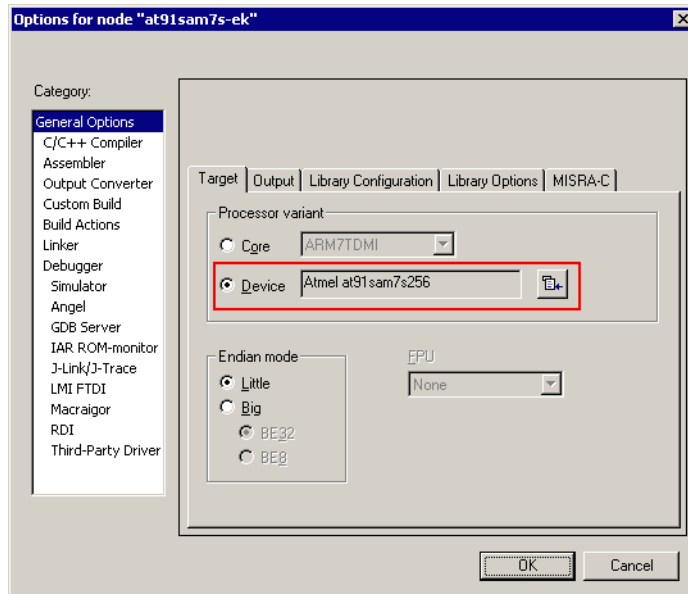

To use the J-Link flash loaders, the IAR flash loader has to be disabled. To disable the IAR flash loader, the checkbox **Use flash loader(s)** at **Project->Options->Debugger->Download** has to be disabled, as shown below.

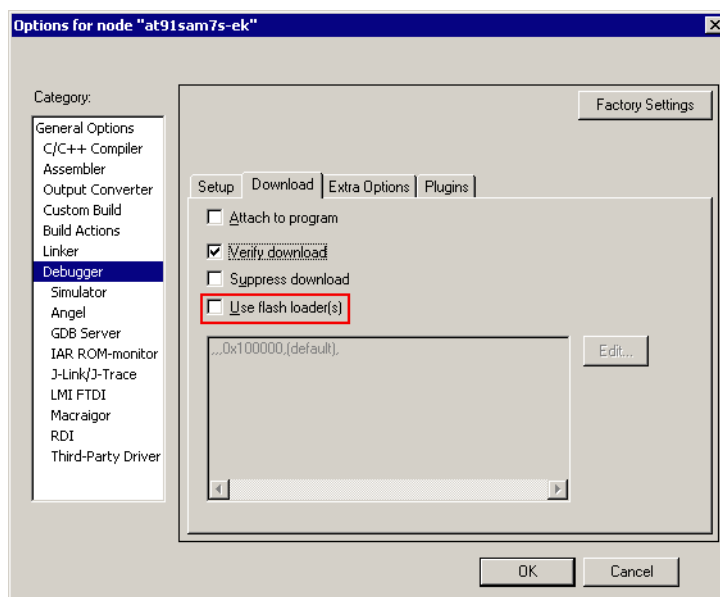

6.4.2 Keil MDK

To use the J-Link flash download feature in Keil MDK, the following steps need to be performed:

First, choose the device in the project settings if not already done. The device settings can be found at **Project->Options for Target->Device**.

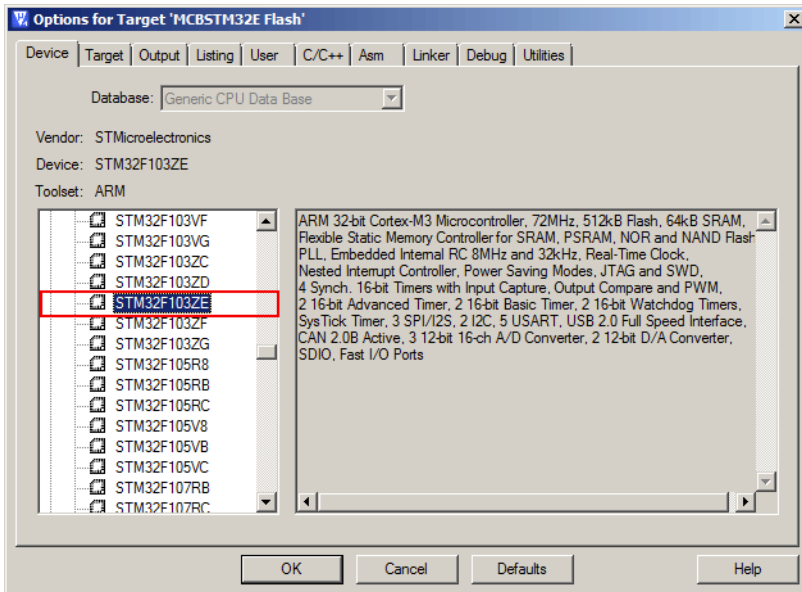

To enable the J-Link flash loader **J-Link / J-Trace** at **Project->Options for Target->Utilities** has to be selected. It is important that "Update Target before Debugging" is unchecked since otherwise uVision tries to use its own flashloader.

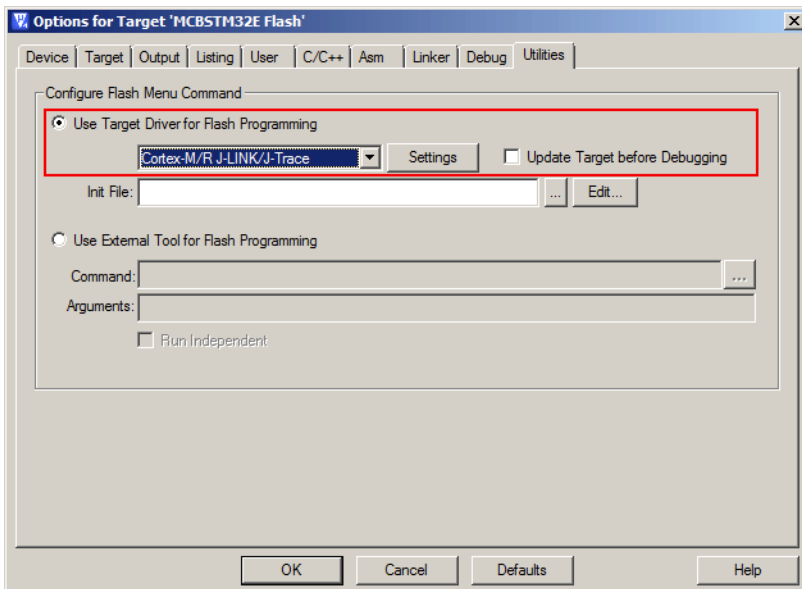

Then J-Link has to be selected as debugger. To select J-Link as debugger simply choose J-Link / J-Trace from the list box which can be found at **Project->Options for Target->Debug**.

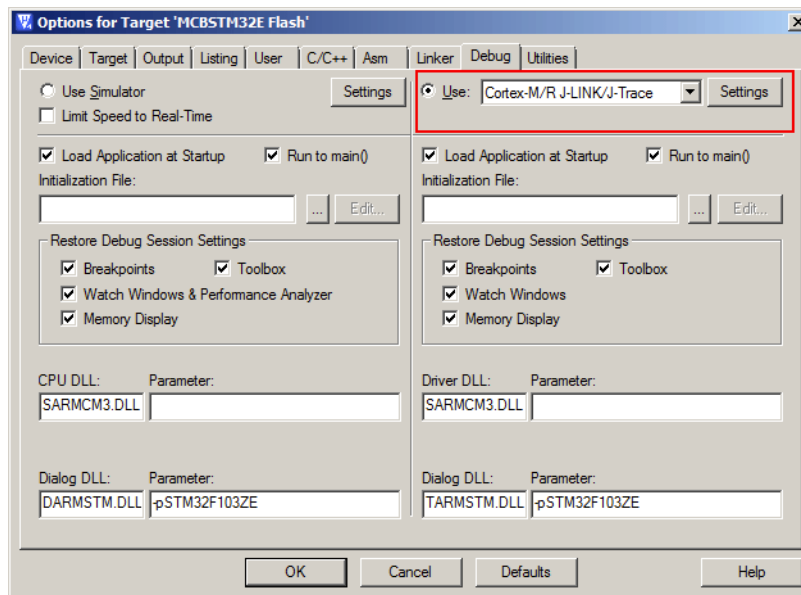

Now setup the **Download Options** at **Project->Options for Target->Debug -> Settings**. Check **Verify Code Download** and **Download to Flash** as shown in the screenshot below.

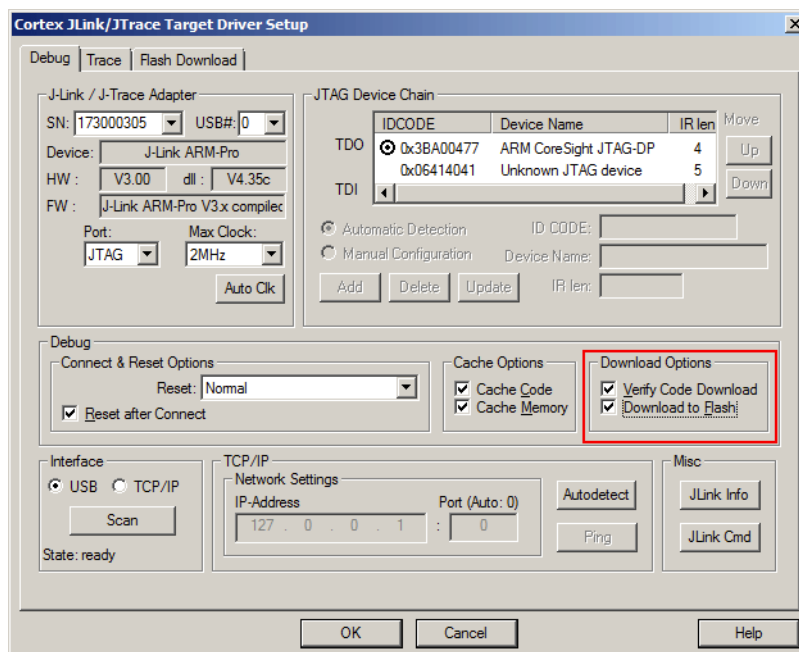

6.4.3 Mentor Sourcery CodeBench

To use the J-Link flash download feature in Mentor Sourcery CodeBench, the following steps need to be performed:

Current versions of Sourcery CodeBench do not pass the device name selected in CodeBench to the J-Link DLL. Therefore a device override via J-Link settings file is needed.

- Copy the J-Link settings file template from
`$JLINK_INST_DIR$\Samples\JLink\SettingsFiles\Sample.jlinksettings`
 to the directory where the CodeBench project is located.
- Open the `Sample.jlinksettings` in a text editor and scroll to the [FLASH] section.
- Change the line
`Device="UNSPECIFIED"`
 to the device name that shall be selected (keep the quotation marks). A list of valid device names can be found here: http://www.segger.com/jlink_supported_devices.html (List of known devices)
- Change the line
`Override = 0`
 to
`Override = 1`
- Select the settings file to be used in Sourcery CodeBench:

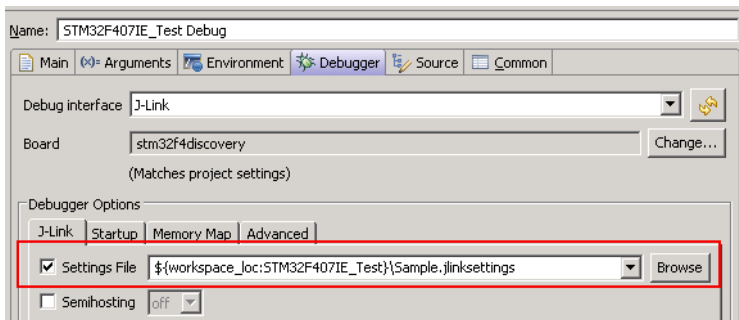

Additional steps for enabling Flash Breakpoints feature

By default, Mentor Sourcery CodeBench does not allow the user to use the J-Link unlimited number of breakpoints in flash feature, since it only allows hardware breakpoints being set, by default. Enabling this feature requires an additional tweak in the J-Link settings file:

- Make sure that all steps from *Mentor Sourcery CodeBench* on page 264, to enable flash download, have been performed.
- Make sure that Sourcery CodeBench uses a J-Link DLL with version V4.85d or later. If an earlier version is used, this tweak does not work.
 To update the DLL used by CodeBench, copy the J-Link DLL from the J-Link installation directory to:
`C:\Tool\C\Mentor\CodeBench\bin\arm-none-eabi-jlinkarm.dll`
- Open the settings file in a text editor and scroll to the [BREAKPOINTS] section.
- Add the line:
`ForceImpTypeAny = 1`
- Make sure that CodeBench uses the settings file.

6.4.4 J-Link GDB Server

The configuration for the J-Link GDB Server is done by the `.gdbinit` file. The following command has to be added to the `.gdbinit` file to enable the J-Link flash download feature:

```
monitor flash device <DeviceName>
```

<DeviceName> is the name of the device for which download into internal flash memory shall be enabled. For a list of supported devices, please refer to *Supported devices* on page 260. For more information about the GDB monitor commands please refer to *J-Link GDB Server* on page 104.

6.4.5 J-Link Commander

J-Link Commander supports downloading bin files into internal flash memory of popular microcontrollers. In the following, it is explained which steps are necessary to prepare J-Link Commander for download into internal flash memory.

6.4.5.1 Preparing J-Link Commander for flash download

To configure J-Link Commander for flash download simply select the connected device by typing in the following command:

```
exec device = <DeviceName>
```

<DeviceName> is the name of the device for which download into internal flash memory shall be enabled. For a list of supported devices, please refer to *Supported devices* on page 260. In order to start downloading the binary data file into flash, please type in the following command:

```
loadfile <filename>, <addr>
```

<Filename> is the path of the binary data file which should be downloaded into the flash.

The loadfile command supports .bin, .hex, .mot and .src files

<Addr> is the start address, the data file should be written to.

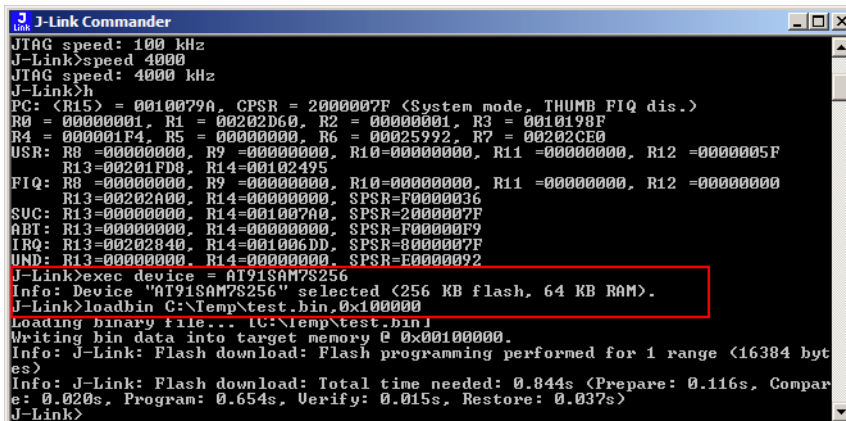

```
J-Link Commander
JTAG speed: 100 kHz
J-Link>speed 4000
JTAG speed: 4000 kHz
J-Link>h
PC: (R15) = 0010079A, CPSR = 2000007F (System mode, THUMB FIQ dis.)
R0 = 00000001, R1 = 00202D60, R2 = 00000001, R3 = 0010198F
R4 = 000001F4, R5 = 00000000, R6 = 00025992, R7 = 00202CE0
USR: R8 = 00000000, R9 = 00000000, R10=00000000, R11 =00000000, R12 =0000005F
R13=00201FD8, R14=00102495
FIQ: R8 =00000000, R9 =00000000, R10=00000000, R11 =00000000, R12 =00000000
R13=00202A00, R14=00000000, SPSP=F0000036
SUC: R13=00000000, R14=001007A0, SPSP=2000007F
ABI: R13=00000000, R14=00000000, SPSP=F00000F9
IRQ: R13=00202840, R14=001006DD, SPSP=8000007F
UND: R13=00000000, R14=00000000, SPSP=E0000072
J-Link>exec device = AT91SAM7S256
Info: Device "AT91SAM7S256" selected (256 KB flash, 64 KB RAM).
J-Link>loadbin C:\Temp\test.bin,0x100000
Loading binary file... IC:\Temp\test.bin
Writing bin data into target memory @ 0x00100000.
Info: J-Link: Flash download: Flash programming performed for 1 range (16384 bytes)
Info: J-Link: Flash download: Total time needed: 0.844s (Prepare: 0.116s, Compare: 0.020s, Program: 0.654s, Verify: 0.015s, Restore: 0.037s)
J-Link>
```

6.4.6 J-Link RDI

The configuration for J-Link RDI is done via the J-Link RDI configuration dialog.

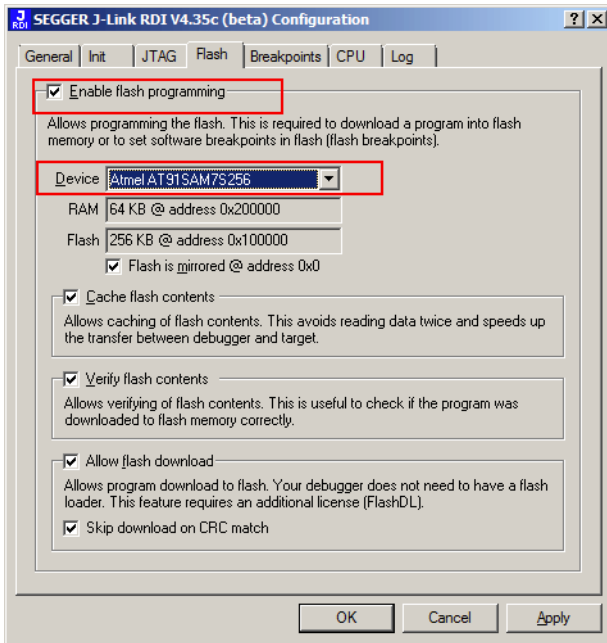

For more information about the J-Link RDI configuration dialog please refer to *UM08004, J-Link RDI User Guide*, chapter *Configuration dialog*.

6.5 Setup for various debuggers (CFI flash)

The setup for download into CFI-compliant memory is different from the one for internal flash. Initialization of the external memory interface the CFI flash is connected to, is user's responsibility and is expected by the J-Link software to be done prior to performing accesses to the specified CFI area. In this section, the setup for different debuggers is explained.

6.5.1 IAR Embedded Workbench / Keil MDK

Using the J-Link flash download feature with IAR Embedded Workbench / Keil MDK is quite simple:

First, start the debug session and open the J-Link Control Panel. In the tab "Settings" you will find the location of the settings file.

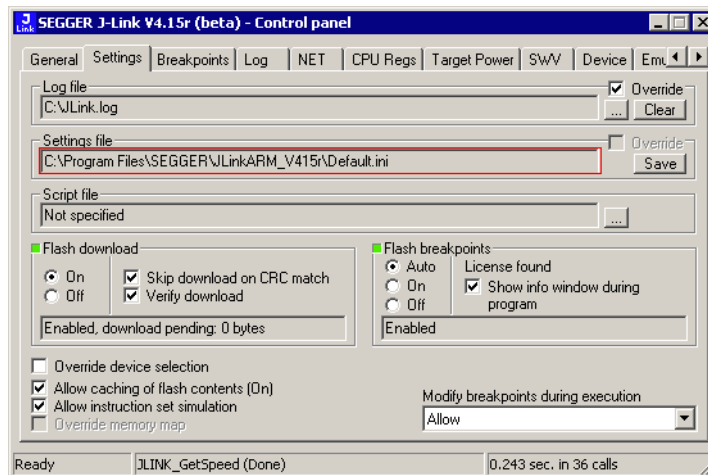

Close the debug session and open the settings file with a text editor. Add the following lines to the file:

```
[CFI]
CFISize = <FlashSize>
CFIAddr = <FlashAddr>
[GENERAL]
WorkRAMSize = <RAMSize>
WorkRAMAddr = <RAMAddr>
```

After this the file should look similar to the sample in the following screenshot.

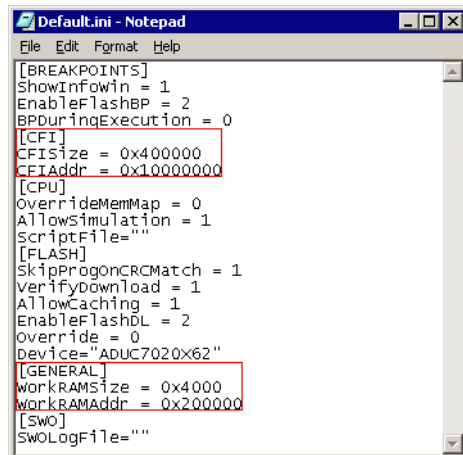

Save the settings file and restart the debug session.

6.5.2 J-Link GDB Server

The configuration for the J-Link GDB Server is done by the `.gdbinit` file. The following commands have to be added to the `.gdbinit` file to enable the flash download feature:

```
monitor WorkRAM = <SAddr>--<EAddr>
monitor flash CFI = <SAddr>--<EAddr>
```

For more information about the GDB monitor commands please refer to *J-Link GDB Server* on page 104.

6.5.3 J-Link commander

J-Link Commander supports downloading bin files into external CFI flash memory. In the following, it is explained which steps are necessary to prepare J-Link Commander for download into external CFI flash memory based on a sample sequence for a ST STM32F103ZE device:

```
r
speed 1000
exec setcfiflash 0x64000000 - 0x64FFFFFF
exec setworkram 0x20000000 - 0x2000FFFF
w4 0x40021014, 0x00000114 // RCC_AHBENR, FSMC clock enable
w4 0x40021018, 0x000001FD // GPIOD~G clock enable
w4 0x40011400, 0xB4BB44BB // GPIOD low config, NOE, NWE => Output, NWAIT => Input
w4 0x40011404, 0BBBBBBBB // GPIOD high config, A16-A18
w4 0x40011800, 0BBBBBBBB // GPIOE low config, A19-A23
w4 0x40011804, 0BBBBBBBB // GPIOE high config, D5-D12
w4 0x40011C00, 0x44BBBBBB // GPIOF low config, A0-A5
w4 0x40011C04, 0BBBBB4444 // GPIOF high config, A6-A9
w4 0x40012000, 0x44BBBBBB // GPIOG low config, A10-A15
w4 0x40012004, 0x444B4BB4 // GPIOG high config, NE2 => output
w4 0xA0000008, 0x00001059 // CS control reg 2, 16-bit, write enable, Type: NOR flash
w4 0xA000000C, 0x10000505 // CS2 timing reg (read access)
w4 0xA000010C, 0x10000505 // CS2 timing reg (write access)
speed 4000
mem 0x64000000,100
loadfile C:\STMB672_STM32F103ZE_TestBlinky.bin,0x64000000
mem 0x64000000,100
```

6.6 Setup for various debuggers (SPIFI flash)

The J-Link DLL supports programming of SPIFI flash and the J-Link flash download feature can be used therefor by different debuggers, such as IAR Embedded Workbench, Keil MDK, GDB based IDEs, ...

There is nothing special to be done by the user to also enable download into SPIFI flash. The setup and behavior is the same as if download into internal flash. For more information about how to setup different debuggers for downloading into SPIFI flash memory, please refer to *Setup for various debuggers (internal flash)* on page 261.

6.7 QSPI flash support

The J-Link DLL also supports programming of any (Q)SPI flash connected to a device that is supported by the J-Link DLL, if the device allows memory-mapped access to the flash. Most modern MCUs / CPUs provide a so called "QSPI area" in their memory-map which allows the CPU to read-access a (Q)SPI flash as regular memory (RAM, internal flash etc.).

6.7.1 Setup the DLL for QSPI flash download

There is nothing special to be done by the user to also enable download into a QSPI flash connected to a specific device. The setup and behavior is the same as if download into internal flash, which mainly means the device has to be selected and nothing else, would be performed. For more information about how to setup the J-Link DLL for download into internal flash memory, please refer to *Setup for various debuggers (internal flash)* on page 261.

The sectorization, command set and other flash parameters are fully auto-detected by the J-Link DLL, so no special user setup is required.

6.8 Using the DLL flash loaders in custom applications

The J-Link DLL flash loaders make flash behave as RAM from a user perspective, since flash programming is triggered by simply calling the J-Link API functions for memory reading / writing. For more information about how to setup the J-Link API for flash programming please refer to *UM08002 J-Link SDK* documentation (available for SDK customers only).

6.9 Debugging applications that change flash contents at runtime

The J-Link DLL caches flash contents in order to improve overall performance and therefore provide the best debugging experience possible.

In case the debugged application does change the flash contents, it is necessary to disable caching of the effected flash range. This can be done using the J-Link command string [ExcludeFlashCacheRange](#).

The SEGGER Wiki provides an article about this topic that provides further information, for example how to use J-Link command strings with various IDEs.

Chapter 7

Flash breakpoints

This chapter describes how the flash breakpoints feature of the DLL can be used in different debugger environments.

7.1 Introduction

The J-Link DLL supports a feature called flash breakpoints which allows the user to set an unlimited number of breakpoints in flash memory rather than only being able to use the hardware breakpoints of the device. Usually when using hardware breakpoints only, a maximum of 2 (ARM 7/9/11) to 8 (Cortex-A/R) breakpoints can be set. The flash memory can be the internal flash memory of a supported microcontroller or external CFI-compliant flash memory. In the following sections the setup for different debuggers for use of the flash breakpoints feature is explained.

How do breakpoints work?

There are basically 2 types of breakpoints in a computer system: Hardware breakpoints and software breakpoints. Hardware breakpoints require a dedicated hardware unit for every breakpoint. In other words, the hardware dictates how many hardware breakpoints can be set simultaneously. ARM 7/9 cores have 2 breakpoint units (called "watchpoint units" in ARM's documentation), allowing 2 hardware breakpoints to be set. Hardware breakpoints do not require modification of the program code. Software breakpoints are different: The debugger modifies the program and replaces the breakpointed instruction with a special value. Additional software breakpoints do not require additional hardware units in the processor, since simply more instructions are replaced. This is a standard procedure that most debuggers are capable of, however, this usually requires the program to be located in RAM.

What is special about software breakpoints in flash?

Flash breakpoints allows setting an unlimited number of breakpoints even if the user application is not located in RAM. On modern microcontrollers this is the standard scenario because on most microcontrollers the internal RAM is not big enough to hold the complete application. When replacing instructions in flash memory this requires re-programming of the flash which takes much more time than simply replacing a instruction when debugging in RAM. The J-Link flash breakpoints feature is highly optimized for fast flash programming speed and in combination with the instruction set simulation only re-programs flash that is absolutely necessary. This makes debugging in flash using flash breakpoints almost as flawless as debugging in RAM.

What performance can I expect?

Flash algorithm, specially designed for this purpose, sets and clears flash breakpoints extremely fast; on microcontrollers with fast flash the difference between software breakpoints in RAM and flash is hardly noticeable.

How is this performance achieved?

We have put a lot of effort in making flash breakpoints really usable and convenient. Flash sectors are programmed only when necessary; this is usually the moment execution of the target program is started. A lot of times, more than one breakpoint is located in the same flash sector, which allows programming multiple breakpoints by programming just a single sector. The contents of program memory are cached, avoiding time consuming reading of the flash sectors. A smart combination of software and hardware breakpoints allows us to use hardware breakpoints a lot of times, especially when the debugger is source level-stepping, avoiding re-programming the flash in these situations. A built-in instruction set simulator further reduces the number of flash operations which need to be performed. This minimizes delays for the user, while maximizing the life time of the flash. All resources of the ARM microcontroller are available to the application program, no memory is lost for debugging.

7.2 Licensing

In order to use the flash breakpoints feature a separate license is necessary for each J-Link. For some devices J-Link comes with a device-based license and some J-Link models also come with a full license for flash breakpoints but the normal J-Link comes without any licenses. For more information about licensing itself and which devices have a device-based license, please refer to *Licensing* on page 67.

7.2.1 Free for evaluation and non-commercial use

In general, the unlimited flash breakpoints feature of the J-Link DLL can be used free of charge for evaluation and non-commercial use.

If used in a commercial project, a license needs to be purchased when the evaluation is complete. There is no time limit on the evaluation period. This feature allows setting an unlimited number of breakpoints even if the application program is located in flash memory, thereby utilizing the debugging environment to its fullest.

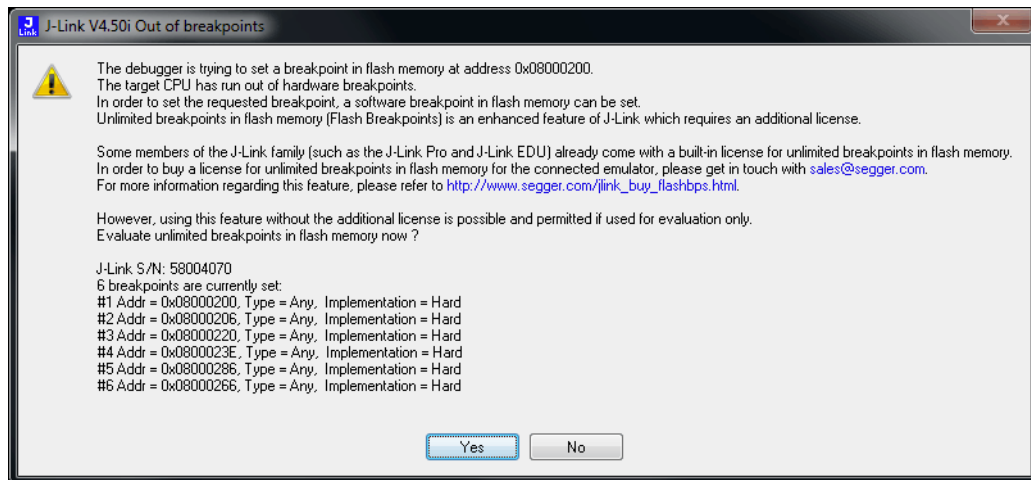

7.3 Supported devices

J-Link supports flash breakpoints for a large number of microcontrollers. You can always find the latest list of supported devices on our website:

http://www.segger.com/jlink_supported_devices.html

In general, J-Link can be used with any ARM7/9/11, Cortex-M0/M1/M3/M4 and Cortex-A5/A8/R4 core even if it does not provide internal flash.

Furthermore, flash breakpoints are also available for all CFI compliant external NOR-flash devices.

7.4 Setup & compatibility with various debuggers

7.4.1 Setup

In compatible debuggers, flash breakpoints work if the J-Link flash loader works and a license for flash breakpoints is present. No additional setup is required. The flash breakpoint feature is available for internal flashes and for external flash (parallel NOR CFI flash as well as QSPI flash). For more information about how to setup various debuggers for flash download, please refer to *Setup for various debuggers (internal flash)* on page 261. Whether flash breakpoints are available can be verified using the J-Link control panel:

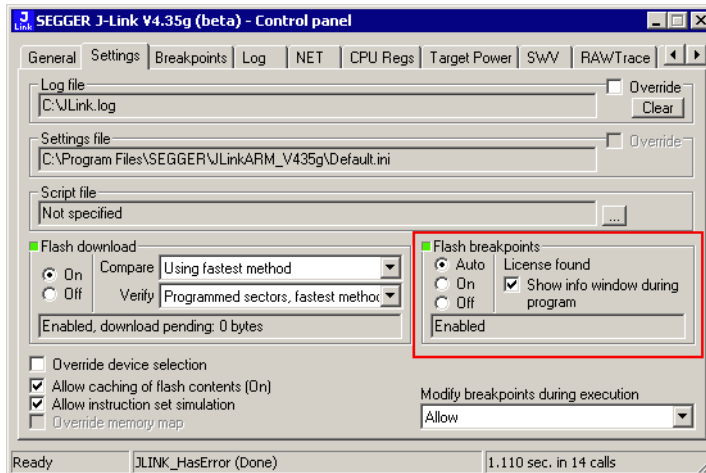

7.4.2 Compatibility with various debuggers

Flash breakpoints can be used in all debugger which use the proper J-Link API to set breakpoints. Compatible debuggers/ debug interfaces are:

- IAR Embedded Workbench
- Keil MDK
- GDB-based debuggers
- Freescale Codewarrior
- Mentor Graphics Sourcery CodeBench
- RDI-compliant debuggers

Incompatible debuggers / debug interfaces:

- Rowley Crossworks

7.5 Flash Breakpoints in QSPI flash

Many modern CPUs allow direct execution from QSPI flash in a so-called "QSPI area" in their memory-map. This feature is called execute-in-place (XIP). On some cores like Cortex-M where hardware breakpoints are only available in a certain address range, sometimes J-Link flash breakpoints are the only possibility to set breakpoints when debugging code running in QSPI flash.

7.5.1 Setup

The setup for the debugger is the same as for downloading into QSPI flash. For more information please refer to *QSPI flash support* on page 270.

7.6 FAQ

- Q: Why can flash breakpoints not be used with Rowley Crossworks?
- A: Because Rowley Crossworks does not use the proper J-Link API to set breakpoints. Instead of using the breakpoint-API, Crossworks programs the debug hardware directly, leaving J-Link no choice to use its flash breakpoints.

Chapter 8

Monitor Mode Debugging

This chapter describes how to use monitor mode debugging support with J-Link.

8.1 Introduction

In general, there are two standard debug modes available for CPUs:

1. Halt mode
2. Monitor mode

Halt mode is the default debug mode used by J-Link. In this mode the CPU is halted and stops program execution when a breakpoint is hit or the debugger issues a halt request. This means that no parts of the application continue running while the CPU is halted (in debug mode) and peripheral interrupts can only become pending but not taken as this would require execution of the debug interrupt handlers. In circumstances halt mode may cause problems during debugging specific systems:

1. Certain parts of the application need to keep running in order to make sure that communication with external components does not break down. This is the case for Bluetooth applications where the Bluetooth link needs to be kept up while the CPU is in debug mode, otherwise the communication would fail and a resume or single stepping of the user application would not be possible
2. Some peripherals are also stopped when the CPU enters debug mode. For example; Pulse-width modulation (PWM) units for motor control applications may be halted while in an undefined / or even dangerous state, resulting in unwanted side-effects on the external hardware connected to these units.

This is where monitor mode debugging becomes effective. In monitor debug mode the CPU is not halted but takes a specific debug exception and jumps into a defined exception handler that executes (usually in a loop) a debug monitor software that performs communication with J-Link (in order to read/write CPU registers and so on). The main effect is the same as for halting mode: the user application is interrupted at a specific point but in contrast to halting mode, the fact that the CPU executes a handler also allows it to perform some specific operations on debug entry / exit or even periodically during debug mode with almost no delay. This enables the handling of such complex debug cases as those explained above.

8.2 Enable Monitor Debugging

As explained before, by default J-Link uses halt mode debugging. In order to enable monitor mode debugging, the J-Link software needs to be explicitly told to use monitor mode debugging. This is done slightly differently from IDE to IDE. In general, the IDE does not notice any difference between halting and monitor debug mode. If J-Link is unable to locate a valid monitor in the target memory, it will default back to halt mode debugging in order to still allow debugging in general.

In the following, some examples on how to enable monitor mode debugging for different IDEs are given:

8.2.1 GDB based debug solutions

For GDB based debug solutions there is a .gdbinit file which contains commands that can be executed by GDB / GDBServer. In this .gdbinit file the following line needs to be added to enable monitor mode debugging (Second command only needed in case of monitor interrupt forwarding, see *Forwarding of Monitor Interrupts* on page 289):

```
monitor exec SetMonModeDebug = 1
monitor exec SetMonModeVTableAddr = <Addr>
```

8.2.2 IAR EWARM

In IAR EWARM there are so-called macro files available to customize certain operations. In this file, the following function with the following line needs to be present (Second line only needed in case of monitor interrupt forwarding, see *Forwarding of Monitor Interrupts* on page 289):

```
/*
 *
 *      execUserSetup()
 *
 *      Function description
 *      Called once after the target application is downloaded.
 *      Implement this macro to set up the memory map, breakpoints,
 *      interrupts, register macro files, etc.
 */
execUserSetup() {
  __message "Macro-execUserSetup(): Enabling monitor mode";
  __jlinkExecCommand("SetMonModeDebug = 1");
  __jlinkExecCommand("SetMonModeVTableAddr = <Addr>");
}
```

The macro file also needs to be selected to be used in the project:

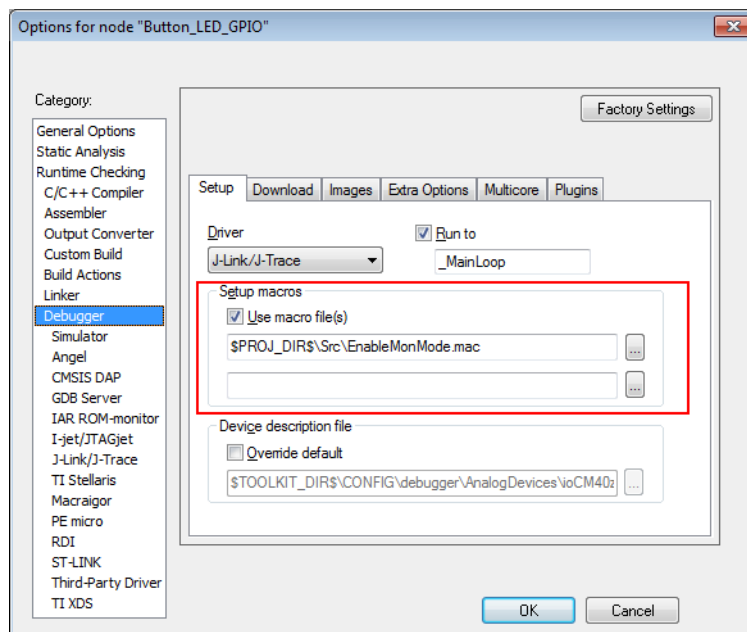

8.2.3 Keil MDK-ARM (uVision)

In Keil MDK-ARM there is no built-in option to pass execs or similar to the J-Link DLL, therefore monitor mode has to be enabled on a per-project basis via the J-Link settings file that is created on start of the first dbeug session with a specific project. For more information where to find the J-Link settings file for a Keil MDK-ARM project, please refer to *The J-Link settings file* on page 215.

To enable monitor mode debugging, the following lines have to be added to the settings file (opened in a text editor), in the [CPU] section (Second line only needed in case of monitor interrupt forwarding, see *Forwarding of Monitor Interrupts* on page 289):

```
[CPU]
MonModeDebug=1
MonModeVTableAddr=<Addr>
```

8.2.4 J-Link Commander

In J-Link Commander, the appropriate command to enable monitor mode can be executed directly (Second command only needed in case of monitor interrupt forwarding, see *Forwarding of Monitor Interrupts* on page 289):

```
J-Link>exec SetMonModeDebug = 1
J-Link>exec SetMonModeVTableAddr = <Addr>
```

8.2.5 Generic way of enabling

There is always the possibility to perform the monitor mode enable command manually via the J-Link control panel. This works independently from the IDE. For more information about the J-Link control panel, please refer to *J-Link control panel* on page 203 (Second command only needed in case of monitor interrupt forwarding, see *Forwarding of Monitor Interrupts* on page 289):

```
exec SetMonModeDebug=1
exec SetMonModeVTableAddr=<Addr>
```

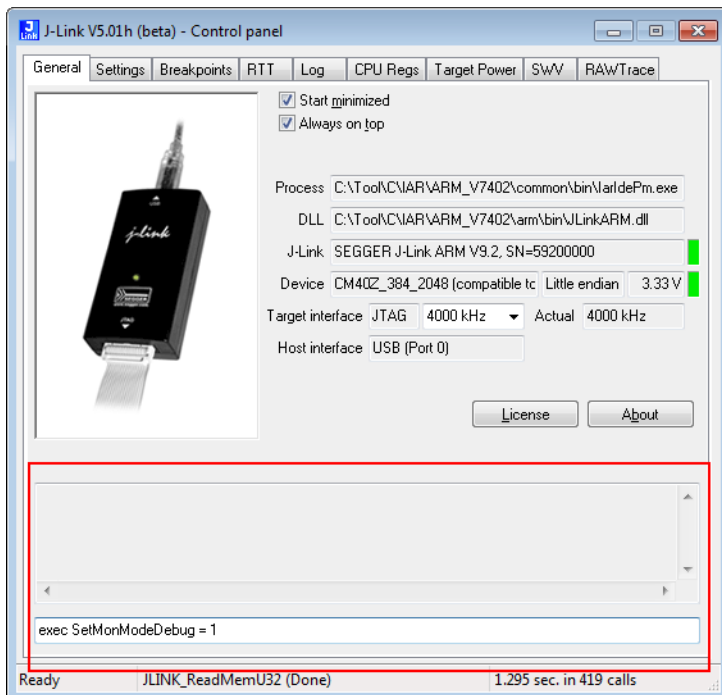

8.3 Availability and limitations of monitor mode

Many CPUs only support one of these debug modes, halt mode or monitor mode. In the following it is explained for which CPU cores monitor mode is available and any limitations, if any.

8.3.1 Cortex-M3

See *Cortex-M4* on page 285.

8.3.2 Cortex-M4

For Cortex-M4, monitor mode debugging is supported. The monitor code provided by SEGGER can easily be linked into the user application.

Considerations & Limitations

- The user-specific monitor functions must not block the generic monitor for more than 100ms.
- Manipulation of the stackpointer register (SP) from within the IDE is not possible as the stackpointer is necessary for resuming the user application on Go().
- The unlimited number of flash breakpoints feature cannot be used in monitor mode. This restriction may be removed in a future version.
- It is not possible to debug the monitor itself, when using monitor mode.

8.4 Monitor code

A CPU core-specific monitor code is necessary to perform monitor mode debugging with J-Link. This monitor performs the communication with J-Link while the CPU is in debug mode (meaning in the monitor exception). The monitor code needs to be compiled and linked as a normal part of the application. Monitors for different cores are available from SEGGER upon request at support_jlink@segger.com.

In general, the monitor code consists of three files:

- `JLINK_MONITOR.c`: Contains user-specific functions that are called on debug mode entry, exit and periodically while the CPU is in debug mode. Functions can be filled with user-specific code. None of the functions must block the generic monitor for more than 100ms.
- `JLINK_MONITOR.h`: Header file to populate `JLINK_MONITOR_` functions.
- `JLINK_MONITOR_ISR.s`: Generic monitor assembler file. (Should not be modified by the user) Do NOT touch.

8.5 Debugging interrupts

In general it is possible to debug interrupts when using monitor mode debugging but there are some things that need to be taken care of when debugging interrupts in monitor mode:

- Only interrupts with a lower priority than the debug/monitor interrupt can be debugged / stepped.
- Setting breakpoints in interrupt service routines (ISRs) with higher priority than the debug/monitor interrupt will result in malfunction because the CPU cannot take the debug interrupt when hitting the breakpoint.

8.6 Having servicing interrupts in debug mode

Under some circumstances it may be useful or even necessary to have some servicing interrupts still firing while the CPU is "halted" for the debugger (meaning it has taken the debug interrupt and is executing the monitor code). This can be for keeping motor controls active or a Bluetooth link etc. In general it is possible to have such interrupts by just assigning a higher priority to them than the debug interrupt has. Please keep in mind that there are some limitations for such interrupts:

- They cannot be debugged
- No breakpoints must be set in any code used by these interrupts

8.7 Forwarding of Monitor Interrupts

In some applications, there might be an additional software layer that takes all interrupts in the first place and forwards them to the user application by explicitly calling the ISRs from the user application vector table. For such cases, it is impossible for J-Link to automatically check for the existence of a monitor mode handler as the handler is usually linked in the user application and not in the additional software layer, so the DLL will automatically switch back to halt mode debugging. In order to enable monitor mode debugging for such cases, the base address of the vector table of the user application that includes the actual monitor handler, needs to be manually specified. For more information about how to do this for various IDEs, please refer to *Enable Monitor Debugging* on page 283.

8.8 Target application performs reset (Cortex-M)

For Cortex-M based target CPUs if the target application contains some code that issues a reset (e.g. a watchdog reset), some special care needs to be taken regarding breakpoints. In general, a target reset will leave the debug logic of the CPU untouched meaning that breakpoints etc. are left intact, however monitor mode gets disabled (bits in DEMCR get cleared). J-Link automatically restores the monitor bits within a few microseconds, after they have been detected as being cleared without explicitly being cleared by J-Link.

However, there is a small window in which it can happen that a breakpoint is hit before J-Link has restored the monitor bits. If this happens, instead of entering debug mode, a HardFault is triggered. To avoid hanging of the application, a special version of the HardFault_Handler is needed which detects if the reason for the HardFault was a breakpoint and if so, just ignores it and resumes execution of the target application. A sample for such a HardFault handler can be downloaded from the SEGGER website: <https://www.segger.com/downloads/appnotes> "Generic SEGGER HardFault handler".

Chapter 9

Low Power Debugging

This chapter describes how to debug low power modes on a supported target CPU.

9.1 Introduction

As power consumption is an important factor for embedded systems, CPUs provide different kinds of low power modes to reduce power consumption of the target system. The useful this is for the application, the problematic it is during debug. In general, how far debugging target applications that make use of low power modes is possible, heavily depends on the device being used as several behavior is implementation defined and differs from device to device. The following cases are the most common ones:

1. The device provides specific special function registers for debugging to keep some clocks running necessary for debugging, while the device is in a low power mode.
2. The device wakes up automatically, as soon as there is a request by the debug probe on the debug interface
3. The device powers off the debug interface partially, allowing the debug probe to read-access certain parts but does not allow to control the CPU.
4. The device powers off the debug interface completely and the debug probe loses the connection to the device (temporarily)

While cases 1-3 are the most convenient ones from the debug perspective because the low power mode is transparent to the end user, they do not provide a real-world scenario because certain things cannot be really tested if certain clocks are still active which would not be in the release configuration with no debug probe attached. In addition to that, the power consumption is significantly higher than in the release config which may cause problems on some hardware designs which are specifically designed for very low power consumption.

The last case (debug probes temporarily loses connection) usually causes the end of a debug session because the debugger would get errors on accesses like "check if CPU is halted/hit a BP". To avoid this, there is a special setting for J-Link that can be activated, to handle such cases in a better way, which is explained in the following.

9.2 Activating low power mode handling for J-Link

While usually the J-Link DLL handles communication losses as errors, there is a possibility to enable low power mode handling in the J-Link DLL, which puts the DLL into a less restrictive mode (low-power handling mode) when it comes to such loss-cases. The low-power handling mode is disabled by default to allow the DLL to react on target communication breakdowns but this behavior is not desired when debugging cases where the target is unresponsive temporarily. How the low-power mode handling mode is enabled, depends on the debug environment. In the following, the most common scenarios are described:

9.2.1 SEGGER Embedded Studio

Low-power handling mode has to be activated in the J-Link settings file. Open the J-Link settings file in a text editor and add the following line in the [CPU] section:

```
LowPowerHandlingMode = 1
```

For more information about how to locate the settings file, please refer to *The J-Link settings file* on page 215.

9.2.2 Keil MDK-ARM

Low-power handling mode has to be activated in the J-Link settings file. Open the J-Link settings file in a text editor and add the following line in the [CPU] section:

```
LowPowerHandlingMode = 1
```

For more information about how to locate the settings file, please refer to *The J-Link settings file* on page 215.

9.2.3 IAR EWARM

Low-power handling mode has to be activated in the J-Link settings file. Open the J-Link settings file in a text editor and add the following line in the [CPU] section:

```
LowPowerHandlingMode = 1
```

For more information about how to locate the settings file, please refer to *The J-Link settings file* on page 215.

9.2.4 Mentor Sourcery CodeBench for ARM

Low-power handling mode has to be activated in the J-Link settings file. Open the J-Link settings file in a text editor and add the following line in the [CPU] section:

```
LowPowerHandlingMode = 1
```

For more information about how to locate the settings file, please refer to *The J-Link settings file* on page 215.

9.2.5 GDB + GDBServer based setups (Eclipse etc.)

As no settings file is created for such setups, the low-power handling mode has to be activated from the gdbinit / .gdbinit file by adding the following command:

```
monitor exec LowPowerHandlingMode = 1
```

9.3 Restrictions

As the connection to the target is temporary lost while it is in low power mode, some restrictions during debug apply:

- Make sure that the IDE does not perform periodic accesses to memory while the target is in a low power mode. E.g.: Disable periodic refresh of memory windows, close live watch windows etc.
- Avoid issuing manual halt requests to the target while it is in a low power mode.
- Do not try to set breakpoints while the target already is in a low power mode. If a breakpoint in a wake-up routine shall be hit as soon as the target wakes up from low power mode, set this breakpoint before the target enters low power mode.
- Single stepping instructions that enter a low power mode (e.g. WFI/WFE on Cortex-M) is not possible/supported.
- Debugging low power modes that require a reset to wake-up can only be debugged on targets where the debug interface is not reset by such a reset. Otherwise breakpoints and other settings are lost which may result in unpredictable behavior.

J-Link does it's best to handle cases where one or more of the above restrictions is not considered but depending on how the IDE reacts to specific operations to fail, error messages may appear or the debug session will be terminated by the IDE.

Chapter 10

Adding Support for New Devices

This chapter describes how to add support for new devices to the J-Link DLL and software that uses the J-Link DLL.

10.1 Introduction

As the number of devices being available is steadily growing and sometimes in an early stage of the MCU development only a few samples/boards are available that may not be provided to third parties (e.g. SEGGER) to add support for a new device. Also the existence of the device may have confidential status, so it might not be mentioned as being supported in public releases yet. Therefore it might be desirable to be able to add support for new devices on your own, without depending on SEGGER and a new release of the J-Link software package being available.

The J-Link DLL allows customers to add support for new devices on their own. It is also possible to edit/extend existing devices of the device database by for example adding new flash banks (e.g. to add support for internal EEPROM programming or SPIFI programming etc.). This chapter explains how new devices can be added to the DLL and how existing ones can be edited/extended.

10.2 General procedure

By default, the J-Link DLL comes with a build-in device database that defines which device names are known and therefore officially supported by the J-Link DLL and software that uses the J-Link DLL. This list can also be viewed on our website:

http://www.segger.com/jlink_supported_devices.html

It is possible to add new devices to the currently used DLL by specifying them in an XML file, named `JLinkDevices.xml`. It is also possible to edit/extend an device from the built-in device database via this XML file. The DLL is looking for this file in the same directory where the J-Link settings file is located. The location of the settings file depends on the IDE / software being used. For more information about where the settings file is located for various IDEs and software that use the J-Link DLL, please refer to *The J-Link settings file* on page 215.

10.3 Adding a new device

In order to add support for a new device to the J-Link DLL, the following needs to be added to the `JLinkDevices.xml`:

```
<Database>
  <Device>
    <ChipInfo Vendor="..."
              Name="..."
              WorkRAMAddr="..."
              WorkRAMSize="..."
              Core="..." />
    <FlashBankInfo Name="..."
                   BaseAddr="..."
                   MaxSize="..."
                   Loader="..."
                   LoaderType="..." />
  </Device>
</Database>
```

When adding a new device, the following attributes for the `<ChipInfo>` tag are mandatory:

- Vendor
- Name
- Core

In case a `<FlashBankInfo>` tag is also added, the following attributes in addition to the ones mentioned before, become mandatory:

ChipInfo-Tag

- WorkRAMAddr
- WorkRAMSize
- FlashBankInfo

FlashBankInfo-Tag

- Name
- BaseAddr
- MaxSize
- Loader
- LoaderType

For more information about the tags and their attributes, please refer to *XML Tags and Attributes* on page 300.

In order to add more than one device to the device database, just repeat the `<Device> ... </Device>` tag structure from above for each device.

10.4 Editing/Extending an Existing Device

In order to edit/extend a device that is already in the built-in device database of the J-Link DLL, the following needs to be added to the `JLinkDevices.xml`:

```
<Database>
  <Device>
    <ChipInfo Vendor="..."
              Name="..." />
    <FlashBankInfo Name="..."
                  BaseAddr="..."
                  MaxSize="..."
                  Loader="..."
                  LoaderType="..." />
  </Device>
</Database>
```

The attribute `Name` of the tag `<ChipInfo>` must specify exactly the same name as the device in the built-in device database specifies. In case the value of the attribute `BaseAddr` specifies an address of an existing flash bank for the existing device, in the built-in device database, the flash bank from the built-in database is replaced by the one from the XML file.

When adding new flash banks or if the device in the built-in database does not specify any flash banks so far, the same attribute requirements as for adding a new device, apply. For more information, please refer to *Adding a new device* on page 298.

In order to add more than one flash bank, just repeat the `<FlashBankInfo ... />` tag structure from above, inside the same `<Device>` tag.

For more information about the tags and their attributes, please refer to *XML Tags and Attributes* on page 300.

10.5 XML Tags and Attributes

In the following, the valid XML tags and their possible attributes are explained.

General rules

- Attributes may only occur inside an opening tag
- Attribute values must be enclosed by quotation marks

10.5.1 <Database>

Description

Opens the XML file top-level tag. Only present once per XML file.

Valid attributes

This tag has no attributes

Notes

- Must only occur once per XML file
- Must be closed via `</Database>`

10.5.2 <Device>

Description

Opens the description for a new device.

Valid attributes

This tag has no attributes.

Notes

- Must be closed via `</Device>`.
- May occur multiple times in an XML file

10.5.3 <ChipInfo>

Description

Specifies basic information about the device to be added, like the core it incorporates etc.

Valid attributes

Parameter	Meaning
Vendor	String that specifies the name of the vendor of the device. This attribute is mandatory. E.g. Vendor="ST".
Name	Name of the device. This attribute is mandatory. E.g. Name="STM32F407IE"
WorkRAMAddr	Hexadecimal value that specifies the address of a RAM area that can be used by J-Link during flash programming etc. Should not be used by any DMAs on the device. Cannot exist without also specifying WorkRAMSize. If no flash banks are added for the new device, this attribute is optional. E.g. WorkRAMAddr="0x20000000"
WorkRAMSize	Hexadecimal value that specifies the size of the RAM area that can be used by J-Link during flash programming etc. Cannot exist without also specifying WorkRAMAddr. If no flash banks are added for the new device, this attribute is optional. E.g. WorkRAMSize="0x10000"
Core	Specifies the core that the device incorporates. If a new device is added, this attribute is mandatory. E.g. Core="JLINK_CORE_CORTEX_M0" For a list of valid attribute values, please refer to <i>Attribute values - Core</i> on page 301.

Table 10.1: <ChipInfo> attribute list

Notes

- No separate closing tag. Directly closed after attributes have been specified:
<ChipInfo ... />
- Must not occur outside a <Device> tag.

10.5.3.1 Attribute values - Core

The following values are valid for the Core attribute:

- JLINK_CORE_CORTEX_M1
- JLINK_CORE_CORTEX_M3
- JLINK_CORE_CORTEX_M3_R1P0
- JLINK_CORE_CORTEX_M3_R1P1
- JLINK_CORE_CORTEX_M3_R2P0
- JLINK_CORE_CORTEX_M0
- JLINK_CORE_CORTEX_M_V8BASEL
- JLINK_CORE_ARM7
- JLINK_CORE_ARM7TDMI
- JLINK_CORE_ARM7TDMI_R3
- JLINK_CORE_ARM7TDMI_R4
- JLINK_CORE_ARM7TDMI_S
- JLINK_CORE_ARM7TDMI_S_R3
- JLINK_CORE_ARM7TDMI_S_R4
- JLINK_CORE_CORTEX_A8
- JLINK_CORE_CORTEX_A7
- JLINK_CORE_CORTEX_A9
- JLINK_CORE_CORTEX_A12
- JLINK_CORE_CORTEX_A15
- JLINK_CORE_CORTEX_A17
- JLINK_CORE_ARM9
- JLINK_CORE_ARM9TDMI_S
- JLINK_CORE_ARM920T
- JLINK_CORE_ARM922T
- JLINK_CORE_ARM926EJ_S
- JLINK_CORE_ARM946E_S

- JLINK_CORE_ARM966E_S
- JLINK_CORE_ARM968E_S
- JLINK_CORE_ARM11
- JLINK_CORE_ARM1136
- JLINK_CORE_ARM1136J
- JLINK_CORE_ARM1136J_S
- JLINK_CORE_ARM1136JF
- JLINK_CORE_ARM1136JF_S
- JLINK_CORE_ARM1156
- JLINK_CORE_ARM1176
- JLINK_CORE_ARM1176J
- JLINK_CORE_ARM1176J_S
- JLINK_CORE_ARM1176JF
- JLINK_CORE_ARM1176JF_S
- JLINK_CORE_CORTEX_R4
- JLINK_CORE_CORTEX_R5
- JLINK_CORE_RX
- JLINK_CORE_RX62N
- JLINK_CORE_RX62T
- JLINK_CORE_RX63N
- JLINK_CORE_RX630
- JLINK_CORE_RX63T
- JLINK_CORE_RX621
- JLINK_CORE_RX62G
- JLINK_CORE_RX631
- JLINK_CORE_RX65N
- JLINK_CORE_RX21A
- JLINK_CORE_RX220
- JLINK_CORE_RX230
- JLINK_CORE_RX231
- JLINK_CORE_RX23T
- JLINK_CORE_RX24T
- JLINK_CORE_RX110
- JLINK_CORE_RX113
- JLINK_CORE_RX130
- JLINK_CORE_RX71M
- JLINK_CORE_CORTEX_M4
- JLINK_CORE_CORTEX_M7
- JLINK_CORE_CORTEX_M_V8MAINL
- JLINK_CORE_CORTEX_A5
- JLINK_CORE_POWER_PC
- JLINK_CORE_POWER_PC_N1
- JLINK_CORE_POWER_PC_N2
- JLINK_CORE_MIPS
- JLINK_CORE_MIPS_M4K
- JLINK_CORE_MIPS_MICROAPTIV
- JLINK_CORE_EFM8_UNSPEC
- JLINK_CORE_CIP51

10.5.4 <FlashBankInfo>

Description

Specifies a flash bank for the device. This allows to use the J-Link flash download functionality with IDEs, debuggers and other software that uses the J-Link DLL (e.g. J-Link Commander) for this device. The flash bank can then be programmed via the normal flash download functionality of the J-Link DLL. For more information about flash download, please refer to *Flash download* on page 257. For possible limitations etc. regarding newly added flash banks, please refer to *Add. info / Considerations / Limitations* on page 305.

Valid attributes

Parameter	Meaning
Name	String that specifies the name of the flash bank. Only used for visualisation. Can be freely chosen. This attribute is mandatory. E.g. Name="SPIFI flash"
BaseAddr	Hexadecimal value that specifies the start address of the flash bank. The J-Link DLL uses this attribute together with <code>MaxSize</code> to determine which memory write accesses performed by the debugger, shall be redirected to the flash loader instead of being written directly to the target as normal memory access. This attribute is mandatory. E.g. BaseAddr="0x08000000"
MaxSize	Hexadecimal value that specifies the max. size of the flash bank in bytes. For many flash loader types the real bank size may depend on the actual flash being connected (e.g. SPIFI flash where the loader can handle different SPIFI flashes so size may differ from hardware to hardware). Also, for some flash loaders the sectorization is extracted from the flash loader at runtime. The real size of the flash bank may be smaller than <code>MaxSize</code> but must never be bigger. The J-Link DLL uses this attribute together with <code>BaseAddr</code> to determine which memory write accesses performed by the debugger, shall be redirected to the flash loader instead of being written directly to the target as normal memory access. This attribute is mandatory. E.g. MaxSize="0x80000"
Loader	String that specifies path to the ELF file that holds the flash loader. Path can be relative or absolute. If path is relative, it is relative to the location of the JLinkDevices.xml file. This attribute is mandatory. E.g. Loader="ST/MyFlashLoader.elf" For CMSIS flash loaders the file extension is usually FLM, however any extension is accepted by the J-Link DLL.
LoaderType	Specifies the type of the loader specified by <code>Loader</code> . This attribute is mandatory. E.g. LoaderType="FLASH_ALGO_TYPE_CMSIS" For a list of valid attribute values, please refer to <i>Attribute values - LoaderType</i> on page 303.

Table 10.2: <FlashBankInfo> attribute list

Notes

- No separate closing tag. Directly closed after attributes have been specified:
<FlashBankInfo ... />
- Must not occur outside a <Device> tag

10.5.4.1 Attribute values - LoaderType

The following values are valid for the `LoaderType` attribute:

- FLASH_ALGO_TYPE_CMSIS
Describes that the used algorithm is an CMSIS algorithm. For additional information, see *Add. info / Considerations / Limitations* on page 305.

10.6 Example XML file

The following shows an example of a complete XML device description file.

```

<Database>
  <Device>
    <ChipInfo Vendor="Vendor0"
      Name="Device0"
      WorkRAMAddr="0x20000000"
      WorkRAMSize="0x4000"
      Core="JLINK_CORE_CORTEX_M0" />
    <FlashBankInfo Name="Int. Flash"
      BaseAddr="0x0"
      MaxSize="0x10000"
      Loader="Vendor0/Loader0.FLM"
      LoaderType="FLASH_ALGO_TYPE_CMSIS" />
    <FlashBankInfo Name="SPIFI Flash"
      BaseAddr="0x30000000"
      MaxSize="0x10000"
      Loader="Vendor0/Loader1.FLM"
      LoaderType="FLASH_ALGO_TYPE_CMSIS" />
  </Device>
  <Device>
    <ChipInfo Vendor="Vendor1"
      Name="Device1"
      WorkRAMAddr="0x20000000"
      WorkRAMSize="0x4000"
      Core="JLINK_CORE_CORTEX_M0" />
    <FlashBankInfo Name="Int. Flash"
      BaseAddr="0x70000000"
      MaxSize="0x10000"
      Loader="Vendor1/Loader0.FLM"
      LoaderType="FLASH_ALGO_TYPE_CMSIS" />
  </Device>
  <Device>
    <ChipInfo Vendor="ST"
      Name="STM32F746NGH6" />
    <FlashBankInfo Name="SPIFI Flash"
      BaseAddr="0x30000000"
      MaxSize="0x80000"
      Loader="ST/STM32F7xx_SPIFI.FLM"
      LoaderType="FLASH_ALGO_TYPE_CMSIS" />
  </Device>
</Database>

```

10.7 Add. info / Considerations / Limitations

Note: SEGGER does not give any guarantee for correct functionality nor provide any support for customized devices / flash banks. Using J-Link support for customized devices that have been added via a XML device description file is done at user's own risk.

In the following, some considerations / limitations when adding support for a new device or editing/extending an existing device, are given:

10.7.1 CMSIS flash algorithms

CMSIS flash algorithms are compatible to the flash algorithms used by Keil MDK / uVision to program flash. An existing FLM file can be simply referenced in a J-Link XML device description. For more information about how to create an CMSIS flash algorithm, please refer to: https://www.keil.com/pack/doc/CMSIS/Pack/html/_flash_algorithm.html.

Currently, only Cortex-M devices are supported via CMSIS algorithms. This is planned to be lifted in a future version.

10.7.2 Customized Flash Banks

Currently, customized flash banks (added via XML device description file) cannot be used in J-Flash and Flasher stand-alone mode. This limitation will be lifted in a future version of the J-Link software.

The unlimited number of breakpoints feature is not available for customized flash banks. This limitation will be lifted in a future version of the J-Link software.

Chapter 11

J-Flash SPI

This chapter describes J-Flash SPI and J-Flash SPI CL, which are separate software (executables) which allow direct programming of SPI flashes, without any additional hardware. Both, J-Flash SPI and J-Flash SPI CL are part of the J-Link software and documentation package which is available free of charge.

This chapter assumes that you already possess working knowledge of the J-Link device.

11.1 Introduction

The following chapter introduces J-Flash SPI, highlights some of its features, and lists its requirements on host and target systems.

11.1.1 What is J-Flash SPI?

J-Flash SPI is a stand-alone flash programming software for PCs running Microsoft Windows, which allows direct programming of SPI flashes, without any additional hardware. The following Microsoft Windows versions are supported:

- Microsoft Windows 2000
- Microsoft Windows XP
- Microsoft Windows XP x64
- Microsoft Windows 2003
- Microsoft Windows 2003 x64
- Microsoft Windows Vista
- Microsoft Windows Vista x64
- Microsoft Windows 7
- Microsoft Windows 7 x64
- Windows 8
- Windows 8 x64
- Windows 10
- Windows 10 x64

J-Flash SPI has an intuitive user interface and makes programming flash devices convenient. J-Flash SPI requires a J-Link or Flasher to interface to the hardware. It is able to program all kinds of SPI flashes, even if the CPU they are connected to, is not supported by J-Link / Flasher because J-Flash SPI communicates directly with the SPI flash bypassing all other components of the hardware.

11.1.2 J-Flash SPI CL (Windows, Linux, Mac)

J-Flash SPI CL is a commandline-only version of the J-Flash SPI programming tool. The command line version is included in the J-Link Software and Documentation Package for Windows, Linux and Mac (cross-platform). Except from the missing GUI, J-Flash SPI CL is identical to the normal version.

The commands, used to configure / control J-Flash SPI CL, are exactly the same as for the command line interface of the J-Flash SPI GUI version. For further information, please refer to *Command Line Interface* on page 321.

11.1.3 Features

- Directly communicates with the SPI flash via SPI protocol, no MCU in between needed.
- Programming of all kinds of SPI flashes is supported.
- Can also program SPI flashes that are connected to CPUs that are not supported by J-Link.
- Supports any kind of custom command sequences (e.g. write protection register)
- Verbose logging of all communication.
- .hex, .mot, .srec, and .bin support.
- Intuitive user interface.

11.1.4 Requirements

11.1.4.1 Host

J-Flash SPI requires a PC running one of the supported operating system (see above) with a free USB port dedicated to a J-Link. A network connection is required only if you want to use J-Flash SPI together with J-Link Remote Server.

11.1.4.2 Target

The flash device must be an SPI flash that supports standard SPI protocols.

11.2 Licensing

The following chapter provides an overview of J-Flash SPI related licensing options.

11.2.1 Introduction

A J-Link PLUS, ULTRA+, PRO or Flasher ARM/PRO is required to use J-Flash SPI. No additional license is required / available.

11.3 Getting Started

This chapter presents an introduction to J-Flash SPI. It provides an overview of the included sample projects and describes the menu structure of J-Flash SPI in detail.

11.3.1 Setup

For J-Link setup procedure required in order to work with J-Flash SPI, please refer to chapter *Setup* on page 167

11.3.1.1 What is included?

The following table shows the contents of all subdirectories of the J-Link software and documentation pack with regard to J-Flash SPI:

Directory	Contents
.	Contains the J-Flash SPI executable.
.\Doc	Contains the J-Flash SPI documentation.
.\Samples\JFlash-SPI\ProjectFiles	Contains sample projects for J-Flash SPI.

Table 11.1: J-Flash SPI directory structure

11.3.2 Using J-Flash SPI for the first time

Start J-Flash SPI from the Windows Start menu. The main window will appear, which contains a log window at the bottom and the **Project window** of a default project on the left. The application log will initially display:

- The version and time of compilation for the application.
- The version and time of compilation for the J-Link DLL.
- The location of the default project.

The Project window contains an overview of the current project settings (initially, a default project is opened).

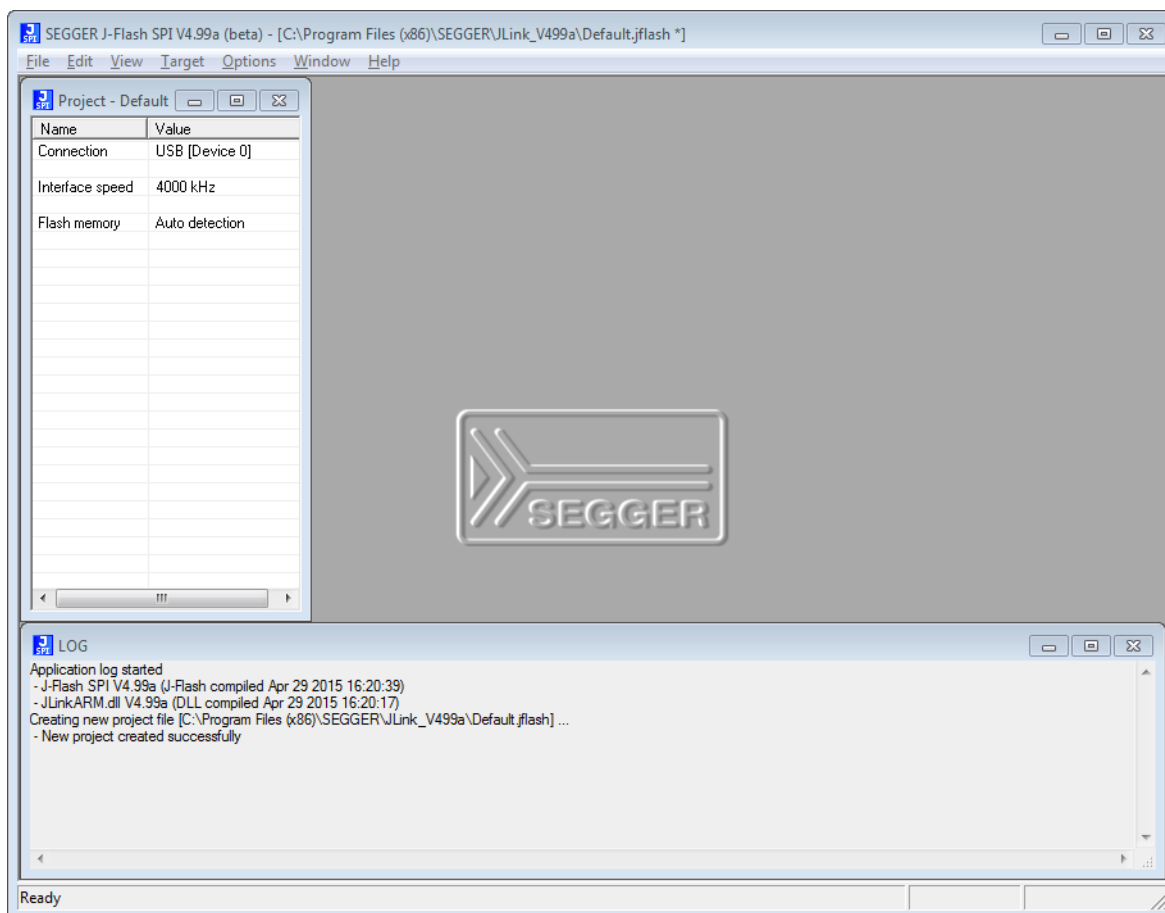

11.3.3 Menu structure

The main window of J-Flash SPI contains seven drop-down menus (**File**, **Edit**, **View**, **Target**, **Options**, **Window**, **Help**). Any option within these drop-down menus that is followed by a three period ellipsis (...), is an option that requires more information before proceeding.

File menu elements

Command	Description
Open data file...	Opens a data file that may be used to flash the target device. The data file must be an Intel HEX file, a Motorola S file, or a Binary file (.hex, .mot, .srec, or .bin).
Merge data file	Merges two data files (.hex, .mot, .srec, or .bin). All gaps will be filled with FF. Find below a short example of merging two data files named, File0.bin and File1.bin into File3.bin. File0.bin --> Addr 0x0200 - 0x02FF File1.bin --> Addr 0x1000 - 0x13FF Merge File0.bin & File1.bin 0x0200 - 0x02FF Data of File0.bin 0x0300 - 0x0FFF gap (will be filled with 0xFF if image is saved as *.bin file) 0x1000 - 0x13FF Data of File1.bin Can be saved in new data file (File3.bin).
Save data file	Saves the data file that currently has focus.
Save data file as...	Saves the data file that currently has focus using the name and location given.
New Project	Creates a new project using the default settings.
Open Project...	Opens a project file. Note that only one project file may be open at a time. Opening a project will close any other project currently open.
Save Project	Saves a project file.
Save Project as...	Saves a project file using the name and location given.
Close Project	Closes a project file.
Recent Files >	Contains a list of the most recently open data files.
Recent Projects >	Contains a list of the most recently open project files.
Exit	Exits the application.

Table 11.2: File menu elements

Edit menu elements

Command	Description
Relocate...	Relocates the start of the data file to the supplied hex offset from the current start location.
Delete range...	Deletes a range of values from the data file, starting and ending at given addresses. The End address must be greater than the Start address otherwise nothing will be done.
Eliminate blank areas...	Eliminates blank regions within the data file.

Table 11.3: Edit menu elements

View menu elements

Command	Description
Log	Opens and/or brings the log window to the active window.
Project	Opens and/or brings the project window to the active window.

Table 11.4: View menu elements

Target menu elements

Command	Description
Connect	Creates a connection through the J-Link using the configuration options set in the Project settings... of the Options drop-down menu.
Disconnect	Disconnects a current connection that has been made through the J-Link.
Test >	Two test functions are implemented: "Generates test data" generates data which can be used to test if the flash can be programmed correctly. The size of the generated data file can be defined. "Tests up/download speed" writes data of an specified size to a defined address, reads the written data back and measures the up- and download speed.
Erase sectors	Erases all selected flash sectors.
Erase chip	Erases the entire chip.
Program	Programs the chip using the currently active data file.
Program & Verify	Programs the chip using the currently active data file and then verifies that it was written successfully.
Auto	The Auto command performs a sequence of steps. It connects to the device, erases sectors and programs the chip using the currently active data file before the written data is finally verified. The range of sectors to be erased can be configured through the Flash tab of the Project settings dialog and through the Global settings dialog.
Verify	Verifies the data found on the chip with the data file.
Read back >	Reads back the data found on the chip and creates a new data file to store this information. There are three ways in which the data can be read back. The Selected sectors identified on the Flash tab of the Project Settings... found in the Options drop-down menu may be read back. The Entire chip may be read back. A specified Range... may be read back.

Table 11.5: Target menu elements

Options menu elements

Command	Description
Project settings...	Location of the project settings that are displayed in the snapshot view found in the Project window of the J-Flash SPI application. Furthermore various settings needed to locate the J-Link and pass specified commands needed for chip initialization.
Global settings...	Settings that influence the general operation of J-Flash SPI.

Table 11.6: Options menu elements

Window menu elements

Command	Description
Cascade	Arranges all open windows, one above the other, with the active window at the top.
Tile Horizontal	Tiles the windows horizontally with the active window at the top.
Tile Vertical	Tiles the windows vertically with the active window at the left.

Table 11.7: Window menu elements

Help menu elements

Command	Description
J-Link User's Guide	Shows the J-Link User's Guide in a PDF viewer such as Adobe Reader.
About...	J-Flash SPI and company information.

Table 11.8: Help menu elements

11.4 Settings

The following chapter provides an overview of the program settings. Both general and per project settings are considered.

11.4.1 Project Settings

Project settings are available from the Options menu in the main window or by using the ALT-F7 keyboard shortcut.

11.4.1.1 General Settings

This dialog is used to choose the connection to J-Link. The J-Link can either be connected over USB or via TCP/IP to the host system. Refer to the J-Link manual for more information regarding the operation of J-Link and J-Link TCP/IP Server.

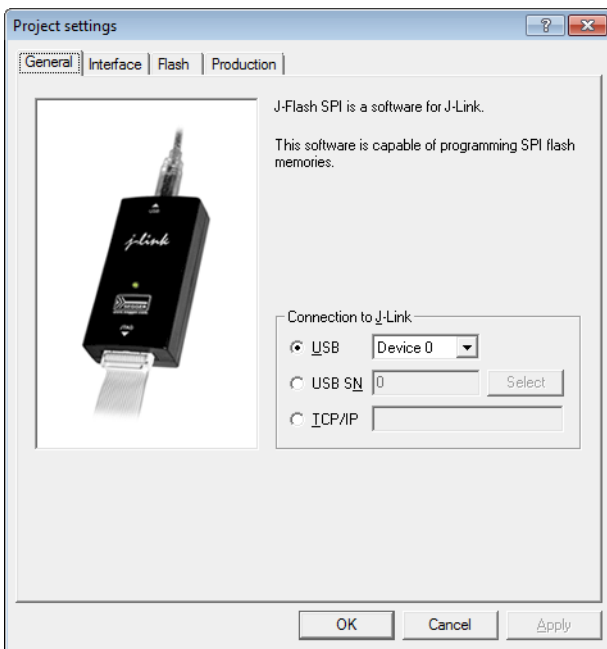

11.4.1.1.1 USB

If this option is checked, J-Flash SPI will connect to J-Link over the USB port. You may change the device number if you want to connect more than one J-Link to your PC. The default device number is 0. For more information about how to use multiple J-Links on one PC, please see also the chapter "Working with J-Link" of the J-Link User's Guide.

11.4.1.1.2 TCP/IP

If this option is selected, J-Flash SPI will connect to J-Link via J-Link TCP/IP Server. You have to specify the hostname of the remote system running the J-Link TCP/IP Server.

11.4.1.2 Setup

This dialog is used to configure the SPI interface settings like SPI communication speed and allows to add Init steps and Exit steps which can be used to execute custom command sequences.

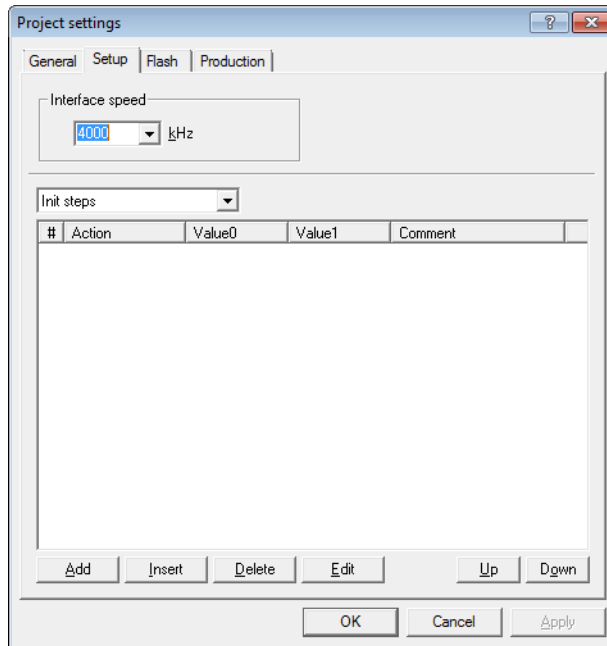

11.4.1.2.1 Interface Speed

Specifies the SPI communication speed J-Link uses to communicate with the SPI flash.

11.4.1.2.2 Init and Exit steps

Can be used to add custom command sequences like for example write protection register. For further information regarding this, please refer to *Custom Command Sequences* on page 326.

11.4.1.3 Flash Settings

This dialog is used to select and configure the parameters of the SPI flash that J-Flash SPI will connect to. Examples for flash parameters are: Sector size (Smallest erasable unit), page size (smallest programmable unit), Flash ID, etc. There is also

the option to try to auto-detect the connected flash device. The latter option will prompt J-Flash SPI to try to identify the flash by its Flash ID, looking up in an internal list of known flash devices.

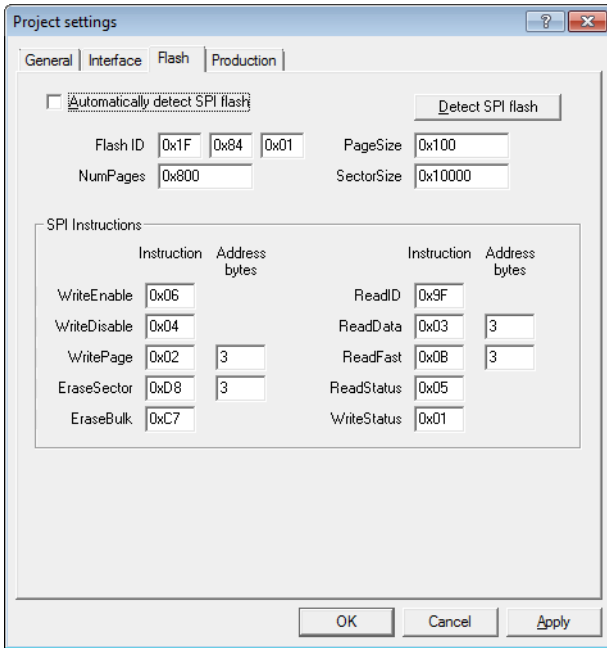

11.4.1.4 Production Settings

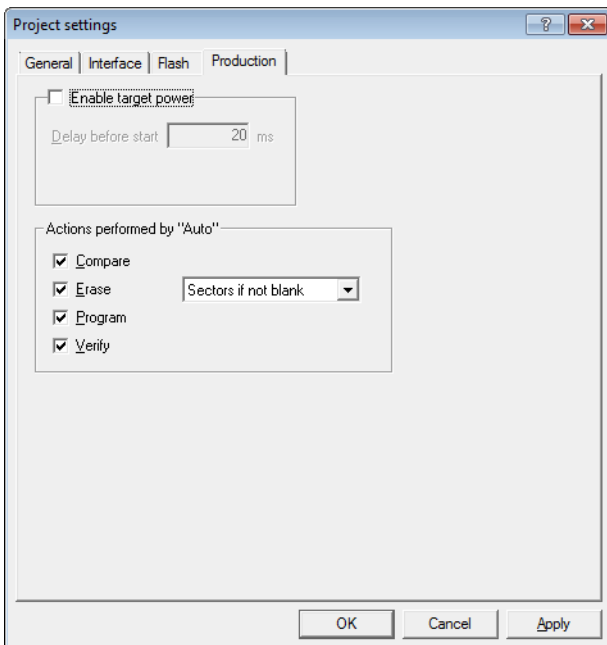

Enable target power

Enables 5V target power supply via pin 19 of the emulator. Can be used for targets which can be powered through the emulator for production. Delay before start defines the delay (in ms) after enabling the target power supply and before starting to communicate with the target.

Actions performed by "Auto"

The checked options will be performed when auto programming a target (Target -> Auto, shortcut: F7) . The default behaviour is Compare, Erase sectors if not blank, Program and Verify. Find below a table which describes the commands:

Command	Description
Compare	Performs a compare of the current flash content and the data to be programmed. Sectors which do already match will be skipped by Erase / Program operation. Note: If Erase is enabled and Erase type is "Chip", the compare will be skipped as after mass erase, the entire device is empty and needs to be re-programmed.
Erase	Performs an erase depending on the settings, selected in the drop down box: <ul style="list-style-type: none"> • Sectors: Erases all sectors which are effected by the image to be programmed. • Sectors if not blank: Erases all sectors which are both, effected by the image to be programmed and not already blank. • Chip: Erase the entire chip independent of the content.
Program	Programs the data file.
Verify	Verifies the programmed data by reading them back.

Table 11.9: Actions performed by "Auto"

11.4.2 Global Settings

Global settings are available from the Options menu in the main window.

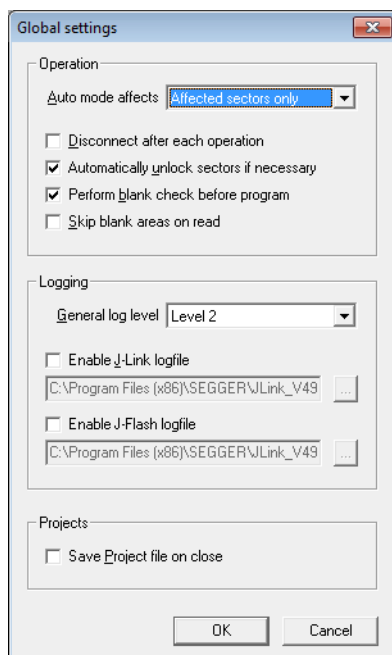

11.4.2.1 Operation

You may define the behavior of some operations such as "Auto" or "Program & Verify".

11.4.2.1.1 Disconnect after each operation

If this option is checked, connection to the target will be closed at the end of each operation.

11.4.2.1.2 Automatically unlock sectors

If this option is checked, all sectors affected by an erase or program operation will be automatically unlocked if necessary.

11.4.2.1.3 Perform blank check

If this option is checked, a blank check is performed before any program operation to examine if the affected flash sectors are completely empty. The user will be asked to erase the affected sectors if they are not empty.

11.4.2.1.4 Skip blank areas on read

If this option is checked, a blank check is performed before any read back operation to examine which flash areas need to be read back from target. This improves performance of read back operations since it minimizes the amount of data to be transferred via JTAG and USB.

11.4.2.2 Logging

You may set some logging options to customize the log output of J-Flash SPI.

11.4.2.2.1 General log level

This specifies the log level of J-Flash SPI. Increasing log levels result in more information logged in the log window.

11.4.2.2.2 Enable J-Link logfile

If this option is checked, you can specify a file name for the J-Link logfile. The J-Link logfile differs from the log window output of J-Flash SPI. It does not log J-Flash SPI operations performed. Instead of that, it logs the J-Link ARM DLL API functions called from within J-Flash SPI.

11.5 Command Line Interface

This chapter describes the J-Flash SPI command line interface. The command line allows using J-Flash SPI in batch processing mode and other advanced uses.

11.5.1 Overview

In addition to its traditional Windows graphical user interface (GUI), J-Flash SPI supports a command line mode as well. This makes it possible to use J-Flash SPI for batch processing purposes. All important options accessible from the menus are available in command line mode as well. If you provide command line options, J-Flash SPI will still start its GUI, but processing will start immediately.

The screenshot below shows the command line help dialog, which is displayed if you start J-Flash SPI in a console window with `JFlashSPI.exe -help` or `JFlashSPI.exe -?`

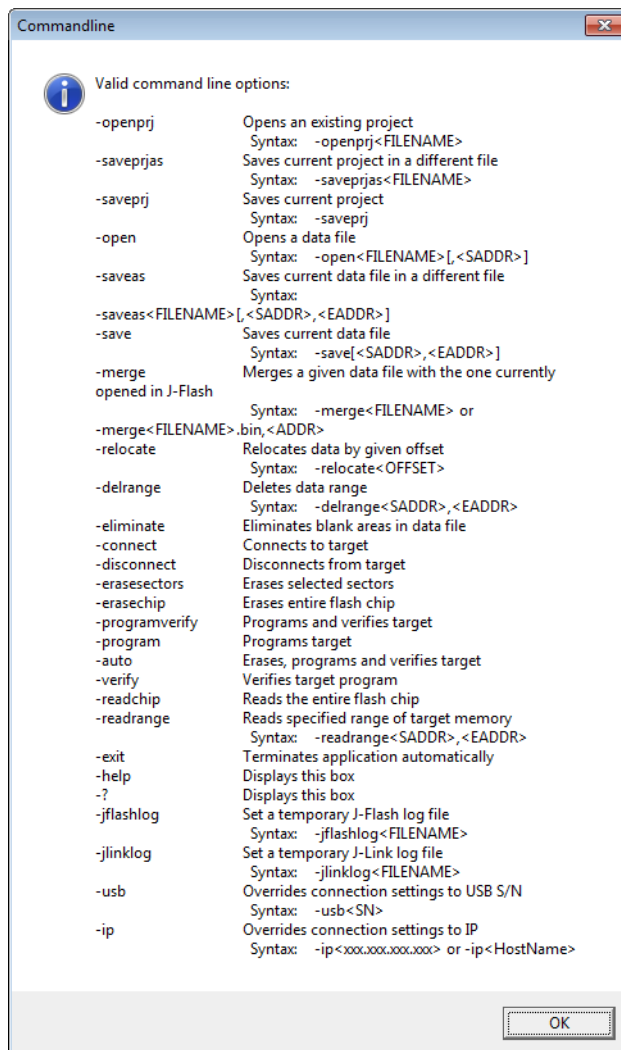

11.5.2 Command line options

This section lists and describes all available command line options. Some options accept additional parameters which are enclosed in angle brackets, e.g. <FILENAME>. If these parameters are optional they are enclosed in square brackets too, e.g. [<SADDR>]. Neither the angle nor the square brackets must be typed on the command line, they are used here only to denote (optional) parameters. Also, note that a parameter must follow immediately after the option, e.g. `JFlashSPI.exe -openprjC:\Projects\Default.jflash`.

The command line options are evaluated in the order they are passed to J-Flash, so please ensure that a project and data file has already been opened when evaluating a command line option which requires this.

It is recommended to always use `-open<FILENAME>[,<SADDR>]` to make sure the right data file is opened.

All command line options return 0 if the processing was successful. A return value unequal 0 means that an error occurred.

Option	Description
-?	Displays help dialog.
-auto	Erases, program and verify target.
-connect	Connects to target.
-delrange<SADDR>,<EADDR>	Deletes data in the given range.
-disconnect	Disconnects from target.
-eliminate	Eliminates blank areas in data file.
-erasechip	Erases the entire flash chip.
-erasesectors	Erases all sectors.
-exit	Exits application.
-help	Displays help dialog.
-merge<FILENAME> -merge<FILENAME>.bin,<ADDR>	Merges a given file with the one currently opened. Note that when passing a .bin file via this command, also the start-address where it shall be merged the file currently opened in J-Flash SPI must be given, too, since .bin files do not contain any address information.
-open<FILENAME>[,<SADDR>]	Open a data file. Please note that the <SADDR> parameter applies only if the data file is a *.bin file.
-openprj<FILENAME>	Open an existing project file. This will also automatically open the data file that has been recently used with this project.
-program	Program target.
-programverify	Program and verify target.
-readchip	Read entire flash chip.
-readrange<SADDR>,<EADDR>	Read specified range of target memory.
-save[<SADDR>,<EADDR>]	Save the current data file. Please note that the parameters <SADDR>,<EADDR> apply only if the data file is a *.bin file or *.c file.
-saveas<FILENAME>[,<SADDR>,<EADDR>]	Save the current data file into the specified file. Please note that the parameters <SADDR>,<EADDR> apply only if the data file is a *.bin file or *.c file.
-saveprj	Save the current project.
-saveprjas<FILENAME>	Save the current project in the specified file.
-verify	Verify target memory.
-usb<SN>	Overrides connection settings to USB.
-ip<xxx.xxx.xxx.xxx> -ip<HostName>	Overrides connection settings to IP.

Table 11.10: J-Flash SPI command line options

11.5.3 Batch processing

J-Flash SPI can be used for batch processing purposes. All important options are available in command line mode as well. When providing command line options, the application does not wait for manual user input. All command line operations will be performed in exactly the order they are passed. So, for example issuing a program command before a project has been opened will cause the program command to fail.

The example batchfile below will cause J-Flash SPI to perform the following operations:

1. Open project C:\Projects\Default.jflash
2. Open bin file C:\Data\data.bin and set start address to 0x100000
3. Perform "Auto" operation in J-Flash (by default this performs erase, program, verify)
4. Close J-Flash SPI

The return value will be checked and in case of an error message will be displayed. Adapt the example according to the requirements of your project.

```
@ECHO OFF

ECHO Open a project and data file, start auto processing and exit
JFlashSPI.exe -openprjC:\Projects\Default.jflash -openC:\Data\data.bin,0x100000 -
auto -exit
IF ERRORLEVEL 1 goto ERROR

goto END

:ERROR
ECHO J-Flash SPI: Error!
pause

:END
```

Starting J-Flash minimized

Adapt this example call to start J-Flash SPI minimized:

```
start /min /wait "J-Flash" "JFlashSPI.exe" -openprjC:\Projects\Default.jflash
\
-openC:\Data\data.bin,0x100000 -auto -exit
```

Note that every call of JFlashSPI.exe has to be completed with the -exit option, otherwise the execution of the batch file stops and the following commands will not be processed.

11.5.4 Programming multiple targets in parallel

In order to program multiple targets in parallel using J-Flash SPI, the following is needed:

- Multiple J-Flash SPI projects, each configured to connect to a specific J-Link / Flasher (emulator to connect to is selected by serial number).

The easiest way is to setup the appropriate project once and then make multiple copies of this project. Now modify the Connection to J-Link setting in each project, in order to let J-Flash SPI connect to the different programmers as shown in the screenshot below:

Find below a small sample which shows how to program multiple targets in parallel:

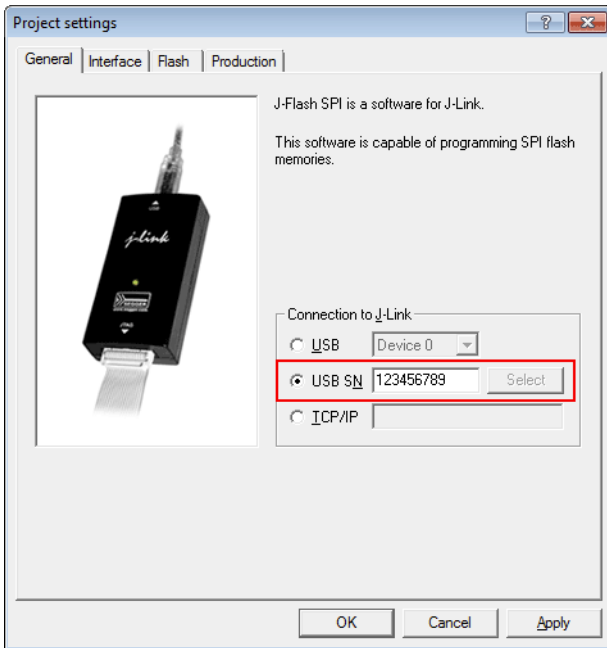

```
@ECHO OFF
```

```
ECHO Open first project which is configured to connect to the first J-Link. Open data file, start auto processing and exit
```

```
open JFlashSPI.exe -openprjC:\Projects\Project01.jflash -openC:\Data\data.bin,0x100000 -auto -exit
IF ERRORLEVEL 1 goto ERROR
```

```
ECHO Open second project which is configured to connect to the second J-Link. Open data file, start auto processing and exit
```

```
open JFlashSPI.exe -openprjC:\Projects\Project02.jflash -openC:\Data\data.bin,0x100000 -auto -exit
IF ERRORLEVEL 1 goto ERROR
```

```
ECHO Open third project which is configured to connect to the third J-Link. Open data file, start auto processing and exit
```

```
open JFlashSPI.exe -openprjC:\Projects\Project03.jflash -openC:\Data\data.bin,0x100000 -auto -exit
IF ERRORLEVEL 1 goto ERROR
```

```
goto END
```

```
:ERROR
```

```
ECHO J-Flash SPI: Error!
```

```
pause
```

```
:END
```

Note that every call of `JFlashSPI.exe` has to be completed with the `-exit` option, otherwise stops the execution of the batch file and the following commands will not be processed.

11.6 Create a new J-Flash SPI project

This chapter contains information about the required steps for the setup of a new J-Flash SPI project.

11.6.1 Creating a new J-Flash SPI project

Creating a new project for J-Flash is pretty simple. In the following, all necessary steps to create a project file are explained.

1. Select **File** -> **New Project** to create a new project with default settings.
2. Open the **Project Settings** context menu. Select **Options** -> **Project Settings** to open the **Project settings** dialog and select the type of connection to J-Link.

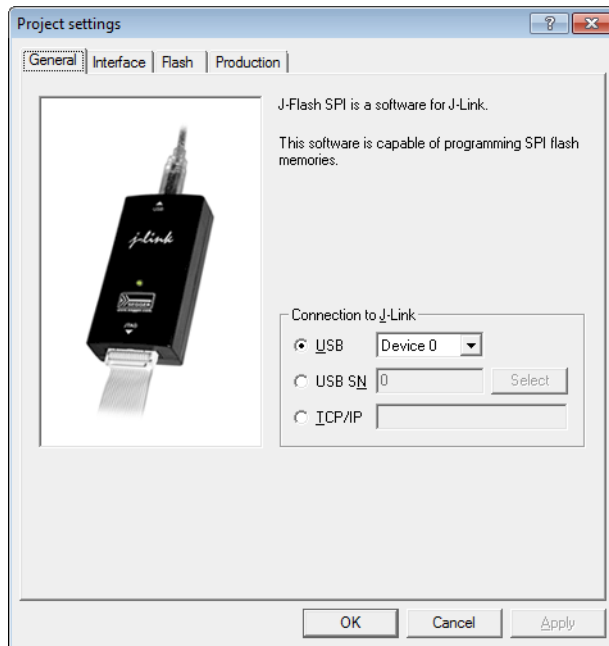

3. Define the **SPI communication speed**. The default settings work without any problem for most targets, but to achieve the last quantum of performance, manual tuning may be necessary.

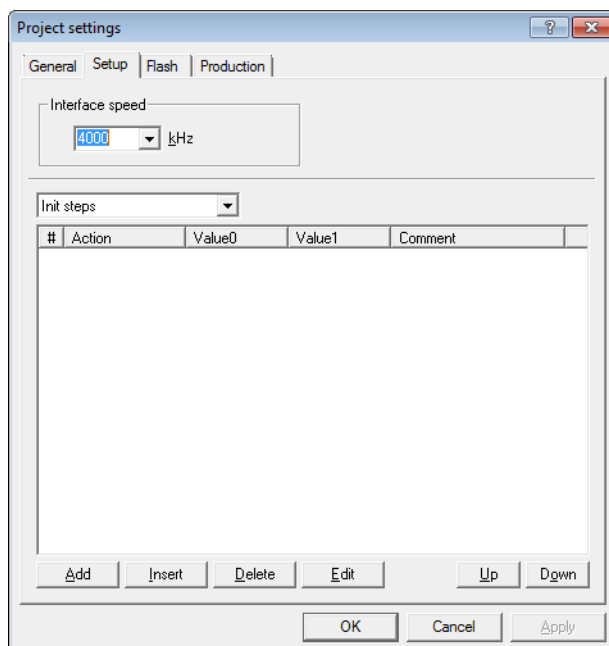

4. Open the **Flash** and either select **Automatically detect SPI flash** or manually enter the flash parameters.
5. Save the project (**File** -> **Save Project**) and test it.

11.7 Custom Command Sequences

J-Flash SPI supports sending custom command sequences, which may be different for different SPI flashes (e.g. program OTP, program security register, etc...), via the SPI interface. Due to the generic syntax, this feature can be used to implement any kind of required command sequence. The sequence is stored in the J-Flash SPI project file (*.jflash) and therefore it can be included in automated production environments without any problems and be used with the command line version of J-Flash SPI as well.

The custom command sequence can be configured in the `Setup` tab of the J-Flash project settings as part of the `Init / Exit Steps` which allow to enter custom sequences using a pre-defined list of operations. The following list shows all valid commands which can be used:

Command	Value0	Value1	Description
Delay	Delay in ms	--	Waits a given time
Activate CS	--	--	Sets the CS signal low
Deactivate CS	--	--	Sets the CS signal high
Write data	NumByte(s)	ByteStream separated by commas (hex)	Send a number of bytes via the SPI interface to the SPI. (e.g.: 9F,13,CA)
Var Read Data	OffInVarBuffer	NumByte(s) max. 16 bytes	Reads the specified number of bytes via the SPI interface into the VarBuffer which is 16 bytes in size.
Var Write Data	OffInVarBuffer	NumByte(s) max. 16 bytes	Writes the specified number of bytes via the SPI interface from the VarBuffer (filled via Var Read).
Var AND	ByteIndex	Value (hex)	Logical AND combination of the internal var buffer at the specified index with a given value.
Var OR	ByteIndex	Value (hex)	Logical OR combination of the internal var buffer at the specified index with a given value.
Var XOR	ByteIndex	Value (hex)	Logical XOR combination of the internal var buffer at the specified index with a given value.

Table 11.11: J-Flash SPI Custom Command Sequence commands

11.7.1 Init / Exit steps

The init sequence will be performed as part of the connect sequence, for example to disable security, while the exit sequence will be executed after programming, for example to enable the security in order to secure the SPI flash.

11.7.2 Example

The example below demonstrates how to use the custom command sequence feature to implement a read-modify-write security register on the Winbond W25Q128FVSIQ SPI flash using the init steps. To make sure that the output of the example is exactly the same, the sample erases the security register to have defined values.

Step #0 to Step#2: Set Write Enable

Step #3 to Step#6: Erase security register to have a defined values (0xFF)

Step #7 to Step#11: Read 16 byte security register into Var buffer

Step #12 to Step#19: Modify the data in the Var buffer

Step #20 to Step#22: Set Write Enable

Step #23 to Step#27: Program security register with values from Var buffer

Step #28 to Step#32: Read back security register to verify successful programming

#	Action	Value0	Value1	Comment
0	Activate CS	--	--	Activate CS
1	Write Data	1	06	Send command: Write Enable
2	Deactivate CS	--	--	Deactivate CS
3	Activate CS	--	--	Activate CS
4	Write Data	4	44,00,10,00	Send command: Erase Security Register 1
5	Deactivate CS	--	--	Deactivate CS
6	Delay	200 ms	--	Wait until security register 1 has been erased
7	Activate CS	--	--	Activate CS
8	Write Data	4	48,00,10,00	Send Read Security Register: 1b command + 3b addr
9	Write Data	1	FF	Send 8 dummy clocks
10	Var Read Data	0	16	Read actual security register data (16 byte) into Varbuffer[0]
11	Deactivate CS	--	--	Deactivate CS
12	Var AND	0	0x00	Set byte 0 to 0x00 using Var AND
13	Var OR	0	0x12	Set byte 0 to 0x12 using Var OR
14	Var AND	6	0x00	Set byte 6 to 0x00 using Var AND
15	Var OR	6	0x12	Set byte 6 to 0xAB using Var OR
16	Var AND	12	0x00	Set byte 12 to 0x00 using Var AND
17	Var OR	12	0x12	Set byte 12 to 0xCC using Var OR
18	Var AND	15	0x00	Set byte 15 to 0x00 using Var AND
19	Var OR	15	0x12	Set byte 15 to 0x4E using Var OR
20	Activate CS	--	--	Activate CS
21	Write Data	1	06	Send command: Write Enable
22	Deactivate CS	--	--	Deactivate CS
23	Activate CS	--	--	Activate CS
24	Write Data	4	42,00,10,00	Send command: Program Security Register 1
25	Var Write Data	0	16	Send data: Program sec reg 1_1
26	Deactivate CS	--	--	Deactivate CS
27	Delay	200 ms	--	Wait until security register 1 has been erased
28	Activate CS	--	--	Activate CS
29	Write Data	4	48,00,10,00	Send Read Security Register: 1b command + 3b addr
30	Write Data	1	FF	Send 8 dummy clocks
31	Var Read Data	0	16	Read actual security register data (16 byte) into Varbuffer[0]
32	Deactivate CS	--	--	Deactivate CS

Table 11.12: J-Flash SPI Custom Command Sequence example

11.7.3 J-Flash SPI Command Line Version

As the Init / Exit Steps are stored in the J-Flash project file, which is evaluated in the command line version of J-Flash SPI too, the custom command sequence feature can be used under Linux / MAC, as well. The project can be either created using the GUI version of J-Flash SPI or by editing the *.jflash project, manually. The expected format of the custom command sequences in the J-Flash project file is described below.

11.7.3.1 J-Flash project layout

Basically, the custom sequence is separated into different steps where each step contains the fields as in the table below. Some commands require to pass parameter to it. They are stored in Value0 and Value1 as described in the table below.

Step	Description
ExitStepX_Action = "\$Action\$"	Any action as described in the table below.
ExitStepX_Comment = "\$Comment\$"	User can specify any comment here. This field is optional and not taken into account.
ExitStepX_Value0 = "\$Value0\$"	Value depends on the action. See table below.
ExitStepX_Value1 = "\$Value1\$"	Value depends on the action. See table below.

The number of exit steps needs to be specified right behind the ExitStep sequence with the line "NumExitSteps = <NumExitSteps>" (see example below).

Actions	Parameter	Description
Activate CS	none	Set CS signal low
Deactive CS	none	Set CS signal high
Write data	Value0=NumBytes Value1[x]=ByteStream max. NumBytes is 16	Send a number of bytes via the SPI interface to the SPI. Please note, that the number of bytes has to be specified right behind Value1 in square brackets (e.g.: ExitStep4_Value1[3] = 0x44,0x00,0x10)
Delay	Value0=Delay in ms	Waits a given time

Below is a small example excerpt from a J-Flash project, which shows a example sequence to erase sector 0 of the SPI flash using the 0xD8 command. Further examples can be found in the installation directory of the J-Link software and documentation package.

```
[CPU]
//
// Set write enable
//
ExitStep0_Action = "Activate CS"
ExitStep0_Value0 = 0x00000000
ExitStep0_Value1 = 0x00000000
ExitStep1_Action = "Write data"
ExitStep1_Comment = "Set write enable"
ExitStep1_Value0 = 1
ExitStep1_Value1[1] = 0x06
ExitStep2_Action = "Deactivate CS"
ExitStep2_Comment = "Deactivate CS"
ExitStep2_Value0 = 0x00000000
ExitStep2_Value1 = 0x00000000
//
// Erase sector 0
//
ExitStep3_Action = "Activate CS"
ExitStep3_Comment = "Activate CS"
ExitStep3_Value0 = 0x00000000
ExitStep3_Value1 = 0x00000000
ExitStep4_Action = "Write data"
ExitStep4_Comment = "Set write enable"
ExitStep4_Value0 = 4
ExitStep4_Value1[4] = 0xD8,0x00,0x00,0x00
ExitStep5_Action = "Deactivate CS"
ExitStep5_Comment = "Deactivate CS"
ExitStep5_Value0 = 0x00000000
ExitStep5_Value1 = 0x00000000
//
```



```
// Wait until sector has been erased
//
ExitStep6_Action = "Delay"
ExitStep6_Comment = "Wait until sector has been erased"
ExitStep6_Value0 = 0x00000080
ExitStep6_Value1 = 0x00000000
NumExitSteps = 7
```

11.8 Device specifics

This chapter gives some additional information about specific devices.

11.8.1 SPI flashes with multiple erase commands

Some SPI flashes support multiple erase commands that allow to erase different units on the flash. For example some flashes provide a `sector erase` (erase 4 KB units) and a `block erase` (erase 16 KB or 64 KB units) command. In general, it is up to the user which command to use, as the `EraseSector` command can be overridden by the user. When manually changing the `SectorErase` command in the **Options -> Project settings... -> Flash** tab, make sure that the `SectorSize` parameter matches the command being used.

11.9 Target systems

11.9.1 Which flash devices can be programmed?

In general, all kinds of SPI flash can be programmed. Since all flash parameters are configurable, also flashes with non-standard command sets can be programmed.

11.10 Performance

The following chapter lists programming performance for various SPI flash devices.

11.10.1 Performance values

In direct programming mode (J-Link directly connects to the pins of the SPI flash), the programming speed is mainly limited by the SPI communication speed, the USB speed of J-Link (if a Full-Speed or Hi-Speed based J-Link is used) and the maximum programming speed of the flash itself.

For most SPI flash devices, in direct programming mode speeds of ≥ 50 KB/s can be achieved.

11.11 Background information

This chapter provides some background information about specific parts of the J-Flash SPI software.

11.11.1 SPI interface connection

For direct SPI flash programming, J-Link needs to be wired to the SPI flash in a specific way. For more information about the pinout for the J-Link SPI target interface, please refer to *UM08001, J-Link J-Trace User Guide*. The minimum pins that need to be connected, are: VTref, GND, SPI-CLK, MOSI, MISO. If other components on the target hardware need to be kept in reset while programming the SPI flash (e.g. a CPU etc.), nRESET also needs to be connected.

11.12 Support

The following chapter provides advises on troubleshooting for possible typical problems and information about how to contact our support.

11.12.1 Troubleshooting

11.12.1.1 Typical problems

Target system has no power

Meaning:

J-Link could not measure the target (flash) reference voltage on pin 1 of its connector.

Remedy:

The target interface of J-Link works with level shifters to be as flexible as possible. Therefore, the reference I/O voltage the flash is working with also needs to be connected to pin 1 of the J-Link connector.

Programming / Erasing failed

Meaning:

The SPI communication speed may be too high for the given signal quality.

Remedy:

Try again with a slower speed. If it still fails, check the quality of the SPI signals.

Failed to verify Flash ID

Meaning:

J-Link could not verify the ID of the connected flash.

Remedy:

Check the Flash ID entered in the flash parameters dialog, for correctness.

11.12.2 Contacting support

If you experience a J-Flash SPI related problem and advice given in the sections above does not help you to solve it, you may contact our support. In this case, please provide us with the following information:

- A detailed description of the problem.
- The relevant log file and project file. In order to generate an expressive log file, set the log level to "All messages" (see section *Global Settings* on page 319 for information about changing the log level in J-Flash SPI).
- The relevant data file as a .hex or .mot file (if possible).
- The processor and flash types used.

Once we received this information we will try our best to solve the problem for you. Our contact address is as follows:

SEGGER Microcontroller GmbH & Co. KG

In den Weiden 11

D-40721 Hilden

Germany

Tel. +49 2103-2878-0

Fax. +49 2103-2878-28

Email: support@segger.com

Internet: <http://www.segger.com>

Chapter 12

RDI

RDI (Remote Debug Interface) is a standard defined by ARM, trying to standardize a debugger / debug probe interface. It is defined only for cores that have the same CPU register set as ARM7 CPUs. This chapter describes how to use the RDI DLL which comes with the J-Link software and documentation package. The J-Link RDI DLL allows the user to use J-Link with any RDI-compliant debugger and IDE.

12.1 Introduction

Remote Debug Interface (RDI) is an Application Programming Interface (API) that defines a standard set of data structures and functions that abstract hardware for debugging purposes. J-Link RDI mainly consists of a DLL designed for ARM cores to be used with any RDI compliant debugger. The J-Link DLL feature flash download and flash breakpoints can also be used with J-Link RDI.

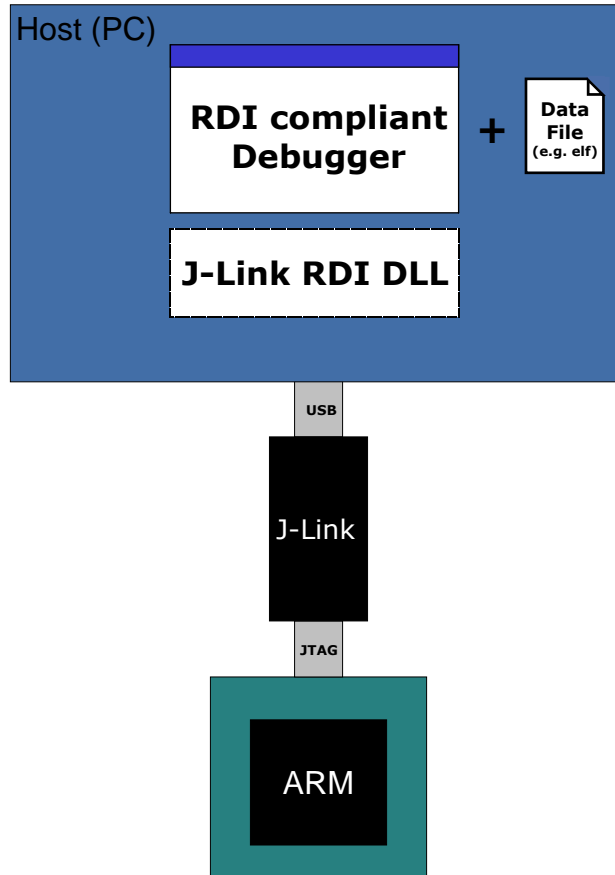

12.1.1 Features

- Can be used with every RDI compliant debugger.
- Easy to use.
- Flash download feature of J-Link DLL can be used.
- Flash breakpoints feature of J-Link DLL can be used.
- Instruction set simulation (improves debugging performance).

12.2 Licensing

In order to use the J-Link RDI software a separate license is necessary for each J-Link. For some devices J-Link comes with a device-based license and some J-Link models also come with a full license for J-Link RDI. The normal J-Link however, comes without any licenses. For more information about licensing itself and which devices have a device-based license, please refer to *Licensing* on page 67.

12.3 Setup for various debuggers

The J-Link RDI software is an ARM Remote Debug Interface (RDI) for J-Link. It makes it possible to use J-Link with any RDI compliant debugger. Basically, J-Link RDI consists of a additional DLL (`JLinkRDI.dll`) which builds the interface between the RDI API and the normal J-Link DLL. The `JLinkRDI.dll` itself is part of the J-Link software and documentation package.

12.3.1 IAR Embedded Workbench IDE

J-Link RDI can be used with IAR Embedded Workbench for ARM.

12.3.1.1 Supported software versions

J-Link RDI has been tested with IAR Embedded Workbench IDE version 4.40. There should be no problems with other versions of IAR Embedded Workbench IDE. All screenshots are taken from IAR Embedded Workbench version 4.40.

Note: Since IAR EWARM V5.30 J-Link is fully and natively supported by EWARM, so RDI is no longer needed.

12.3.1.2 Configuring to use J-Link RDI

1. Start the IAR Embedded Workbench and open the tutor example project or the desired project. This tutor project has been preconfigured to use the simulator driver. In order to run the J-Link RDI, the driver needs to be changed.

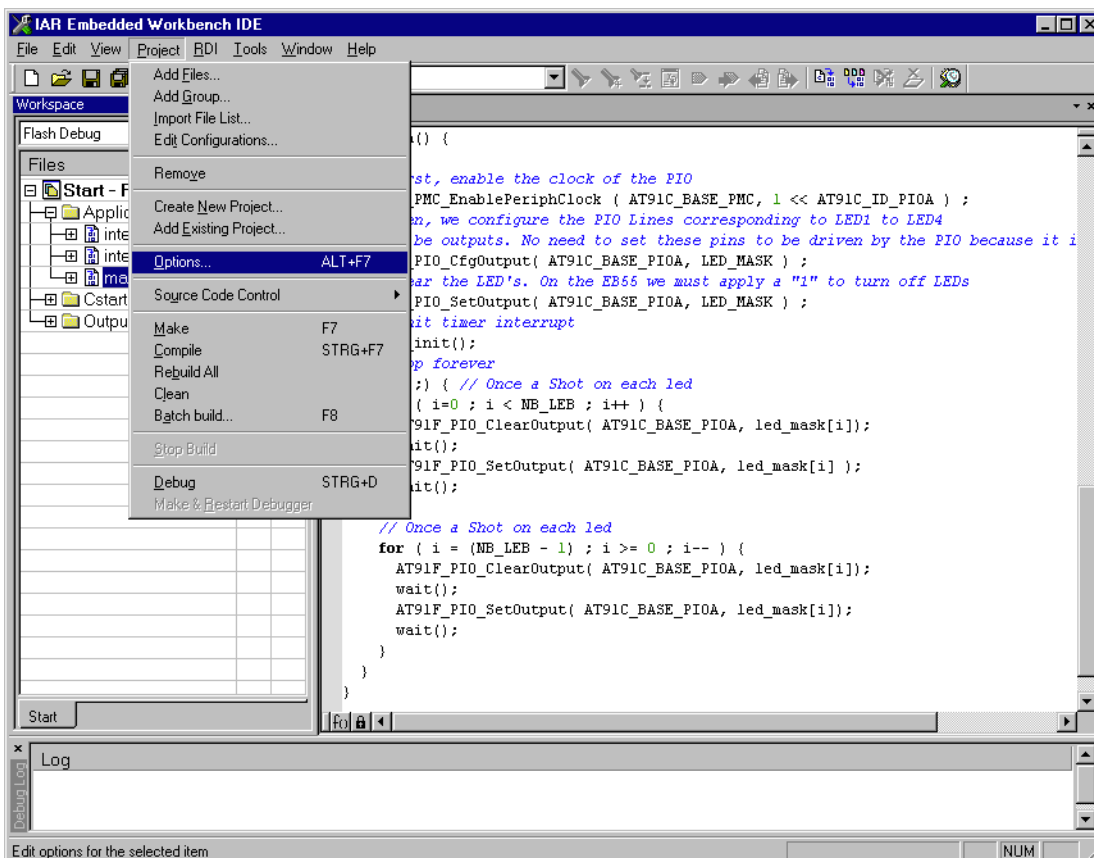

2. Choose **Project | Options** and select the **Debugger** category. Change the

Driver option to RDI.

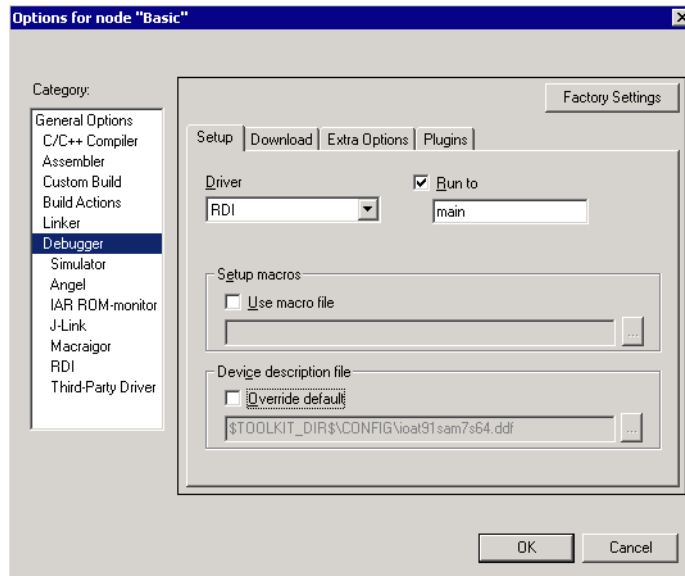

3. Go to the RDI page of the Debugger options, select the manufacturer driver (JLinkRDI.dll) and click **OK**.

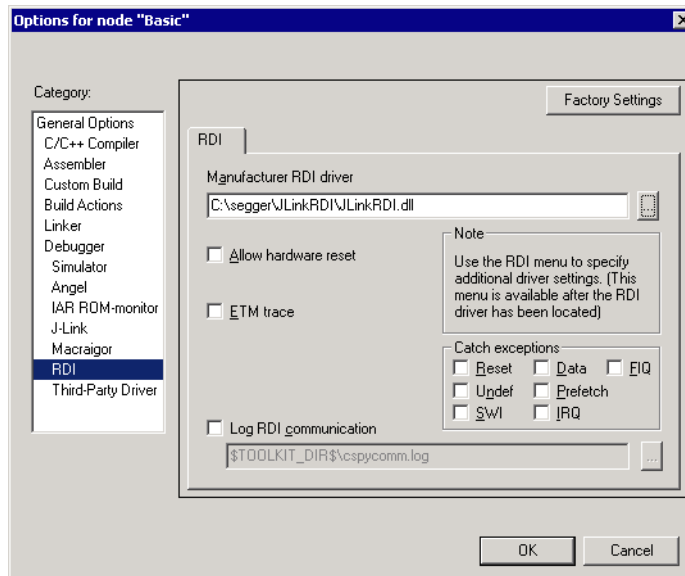

4. Now an extra menu, RDI, has been added to the menu bar. Choose **RDI | Configure** to configure the J-Link. For more information about the generic setup of J-Link RDI, please refer to *Configuration* on page 354.

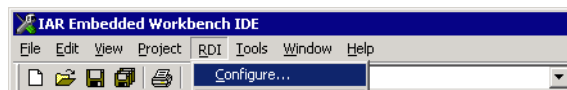

12.3.1.3 Debugging on Cortex-M3 devices

The RDI protocol has only been specified by ARM for ARM 7/9 cores. For Cortex-M there is no official extension of the RDI protocol regarding the register assignment, that has been approved by ARM. Since IAR EWARM version 5.11 it is possible to use J-Link RDI for Cortex-M devices because SEGGER and IAR have come to an agreement regarding the RDI register assignment for Cortex-M. The following table lists the register assignment for RDI and Cortex-M:

Register Index	Assigned register
0	R0
1	R1
2	R2
3	R3
4	R4
5	R5
6	R6
7	R7
8	R8
9	R9
10	R10
11	R11
12	R12
13	MSP / PSP (depending on mode)
14	R14 (LR)
16	R15 (PC)
17	XPSR
18	APSR
19	IPSR
20	EPSR
21	IAPSR
22	EAPSR
23	IEPSR
24	PRIMASK
25	FAULTMASK
26	BASEPRI
27	BASEPRI_MAX
28	CFBP (CONTROL/FAULT/BASEPRI/PRIMASK)

Table 12.1: Cortex-M register mapping for IAR + J-Link RDI

12.3.2 ARM AXD (ARM Developer Suite, ADS)

12.3.2.1 Software version

The `JLinkRDI.dll` has been tested with ARM's AXD version 1.2.0 and 1.2.1. There should be no problems with other versions of ARM's AXD. All screenshots are taken from ARM's AXD version 1.2.0.

12.3.2.2 Configuring to use J-Link RDI

1. Start the ARM debugger and select **Options | Configure Target....** This opens the **Choose Target** dialog box:

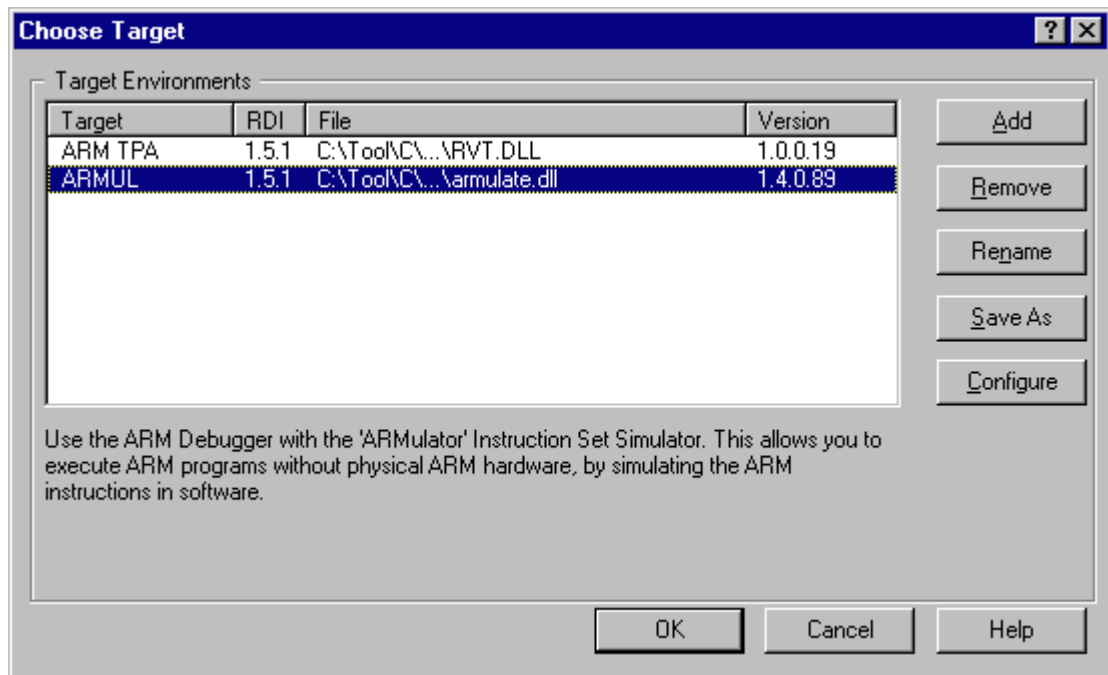

2. Press the **Add** Button to add the `JLinkRDI.dll`.

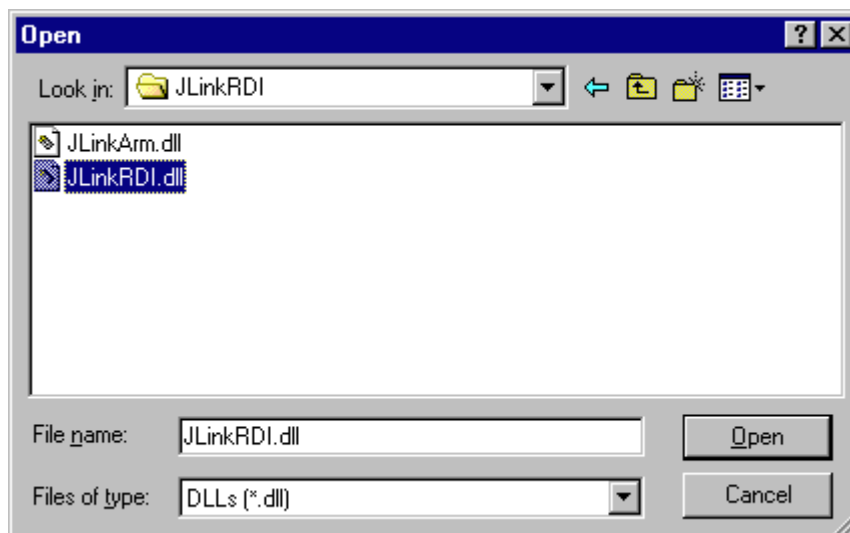

3. Now J-Link RDI is available in the **Target Environments** list.

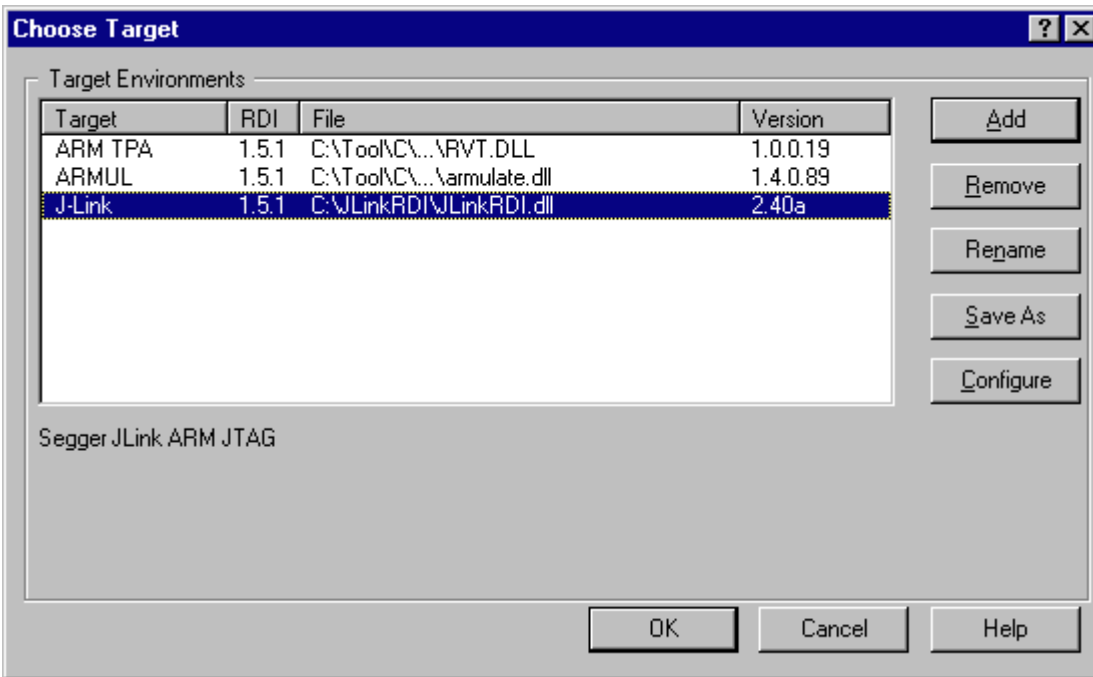

4. Select J-Link and press **OK** to connect to the target via J-Link. For more information about the generic setup of J-Link RDI, please refer to *Configuration* on page 354. After downloading an image to the target board, the debugger window looks as follows:

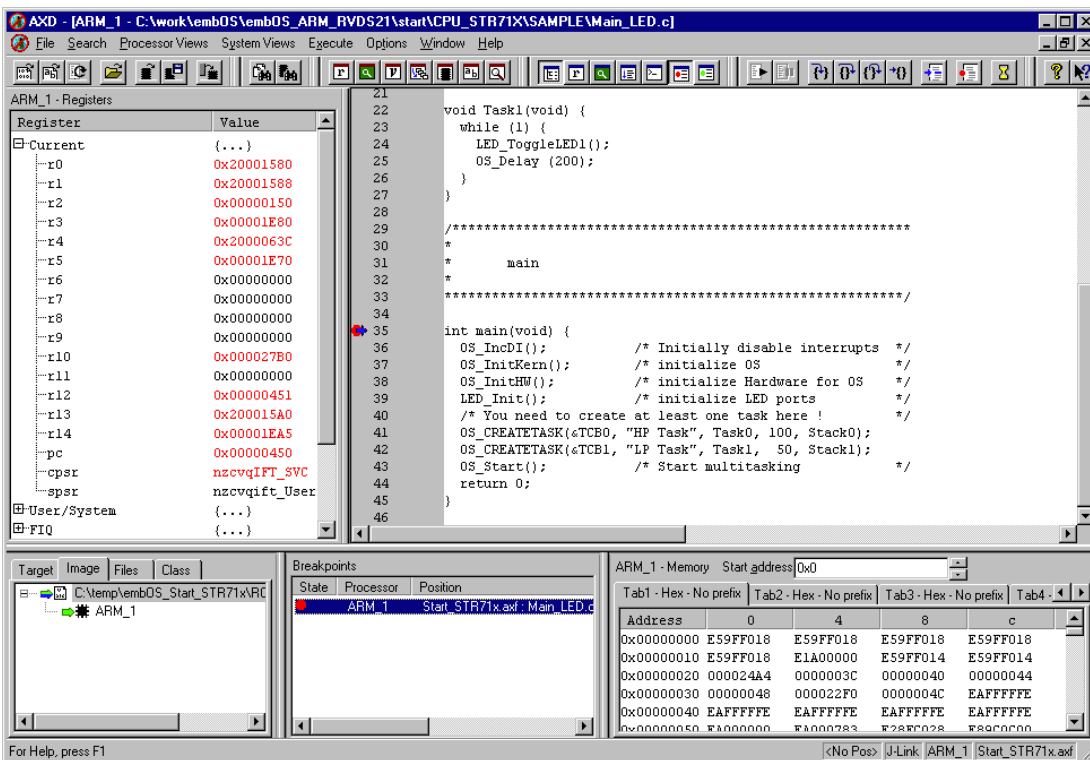

12.3.3 ARM RVDS (RealView developer suite)

12.3.3.1 Software version

J-Link RDI has been tested with ARM RVDS version 2.1 and 3.0. There should be no problems with earlier versions of RVDS (up to version v3.0.1). All screenshots are taken from ARM's RVDS version 2.1.

Note: RVDS version 3.1 does not longer support RDI protocol to communicate with the debugger.

12.3.3.2 Configuring to use J-Link RDI

1. Start the Real View debugger:

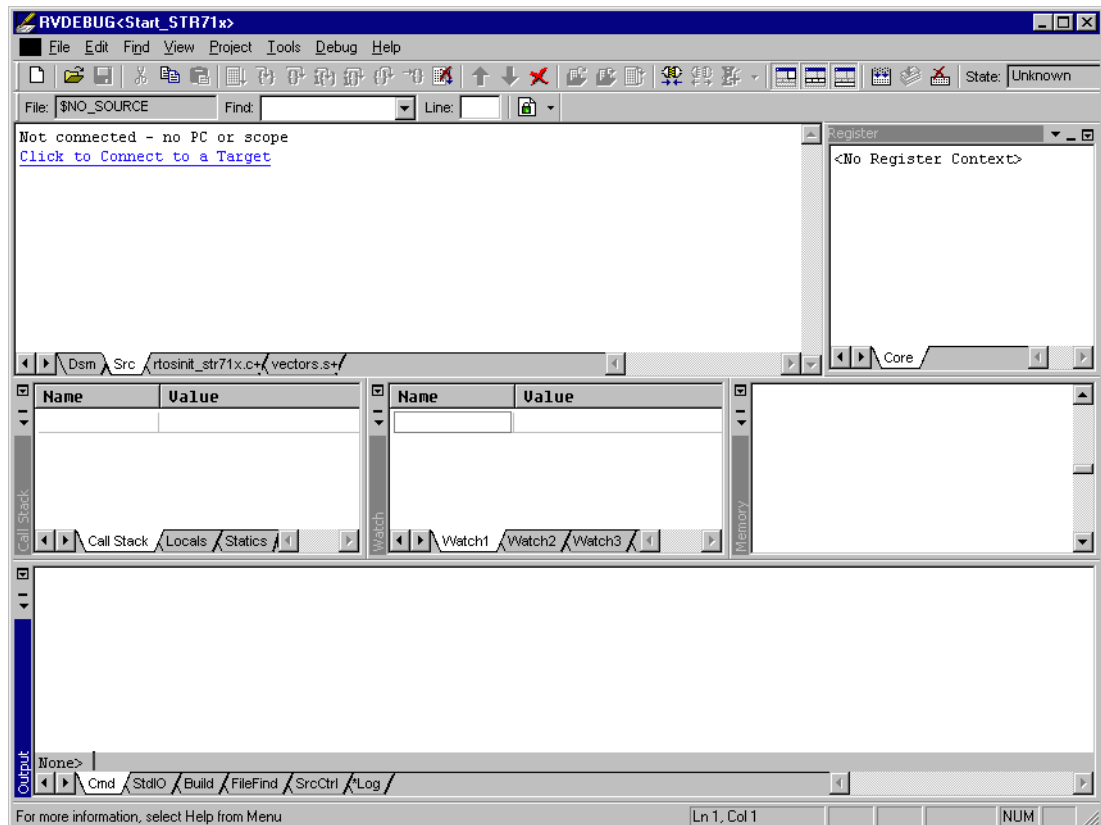

2. Select **File | Connection | Connect to Target.**

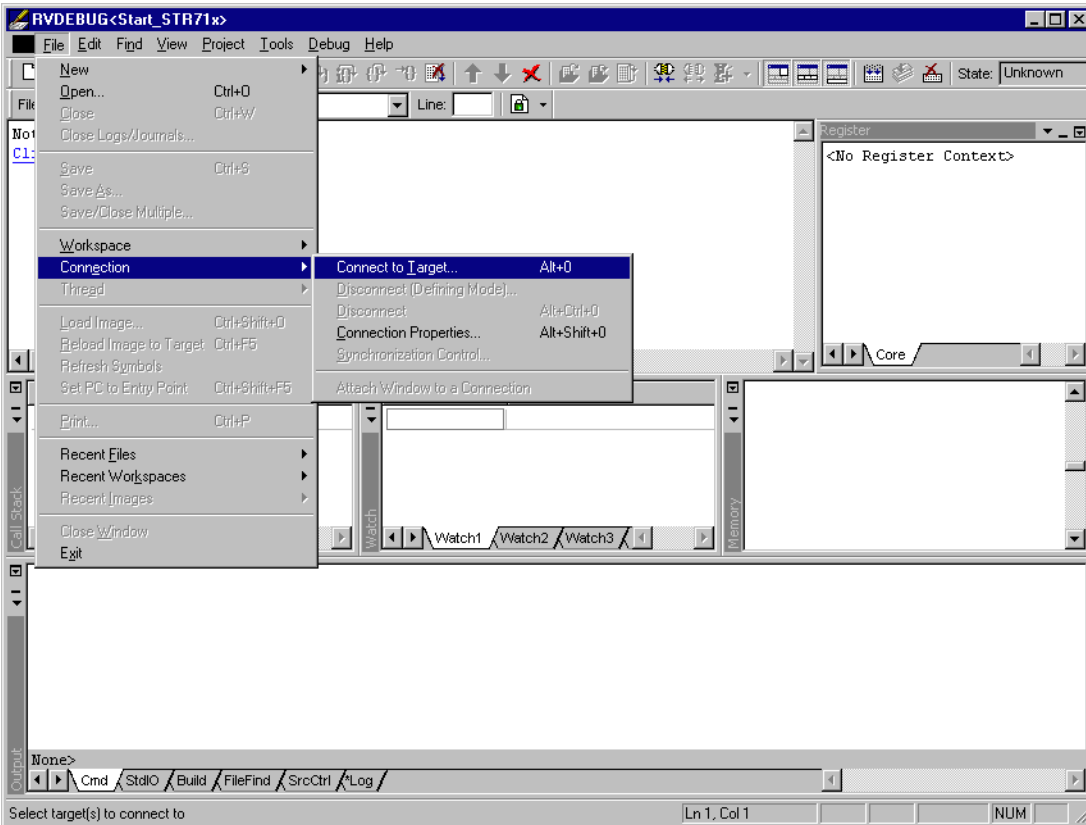

3. In the **Connection Control** dialog use the right mouse click on the first item and select **Add/Remove/Edit Devices.**

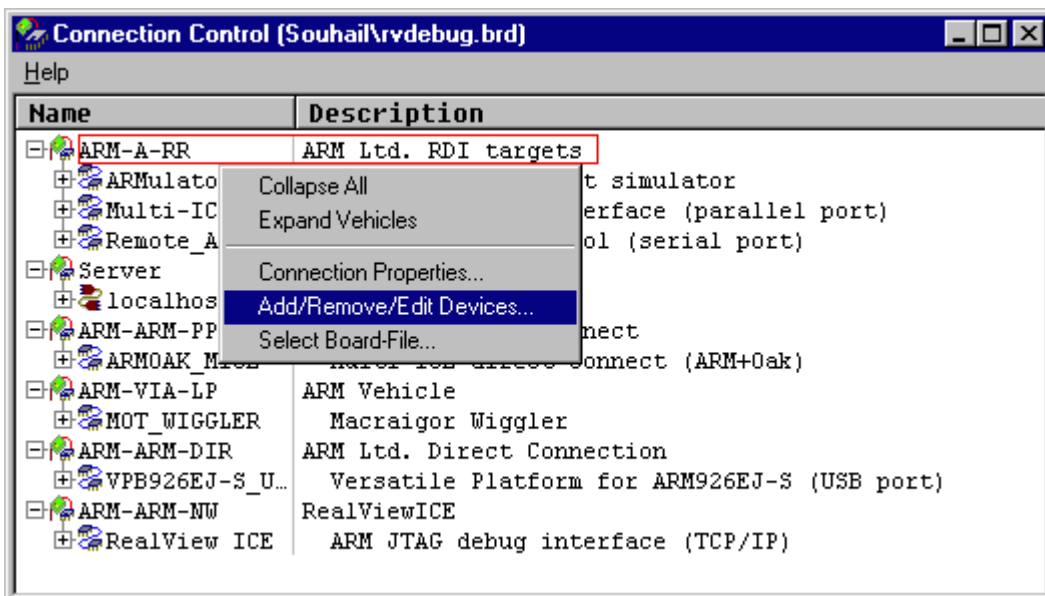

4. Now select **Add DLL** to add the `JLinkRDI.dll`. Select the installation path of the software, for example:

`C:\Program Files\SEGGER\JLinkARM_V350g\JLinkRDI.dll`

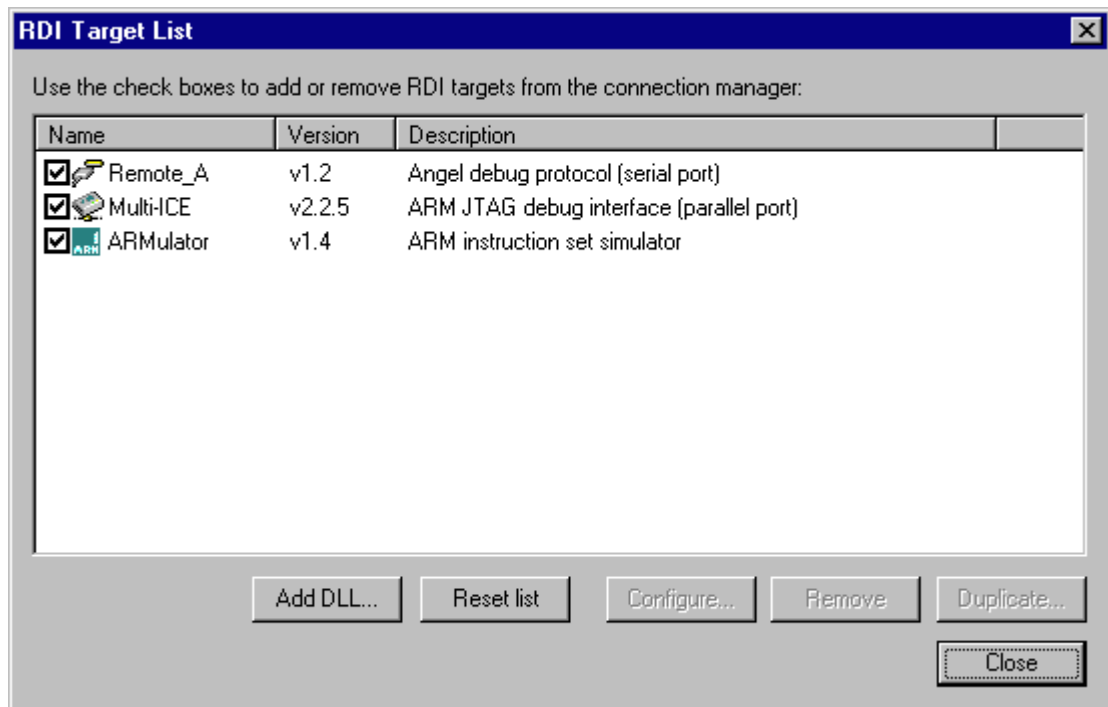

5. After adding the DLL, an additional Dialog opens and asks for description: (These values are voluntary, if you do not want change them, just click **OK**) Use the following values and click on **OK**, **Short Name:** `JLinkRDI` **Description:** `J-Link RDI Interface`.

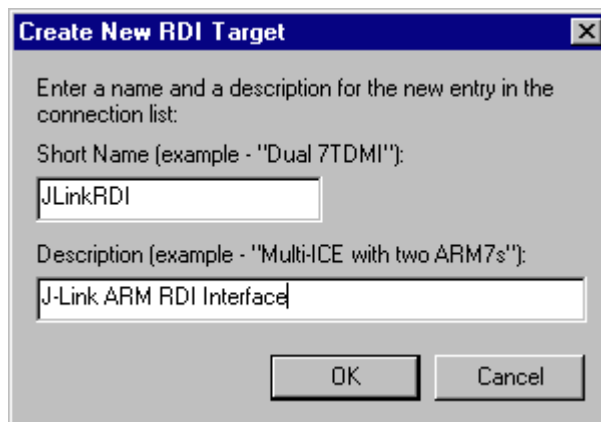

6. Back in the **RDI Target List** Dialog, select **JLink-RDI** and click **Configure**. For more information about the generic setup of J-Link RDI, please refer to *Configuration* on page 354.

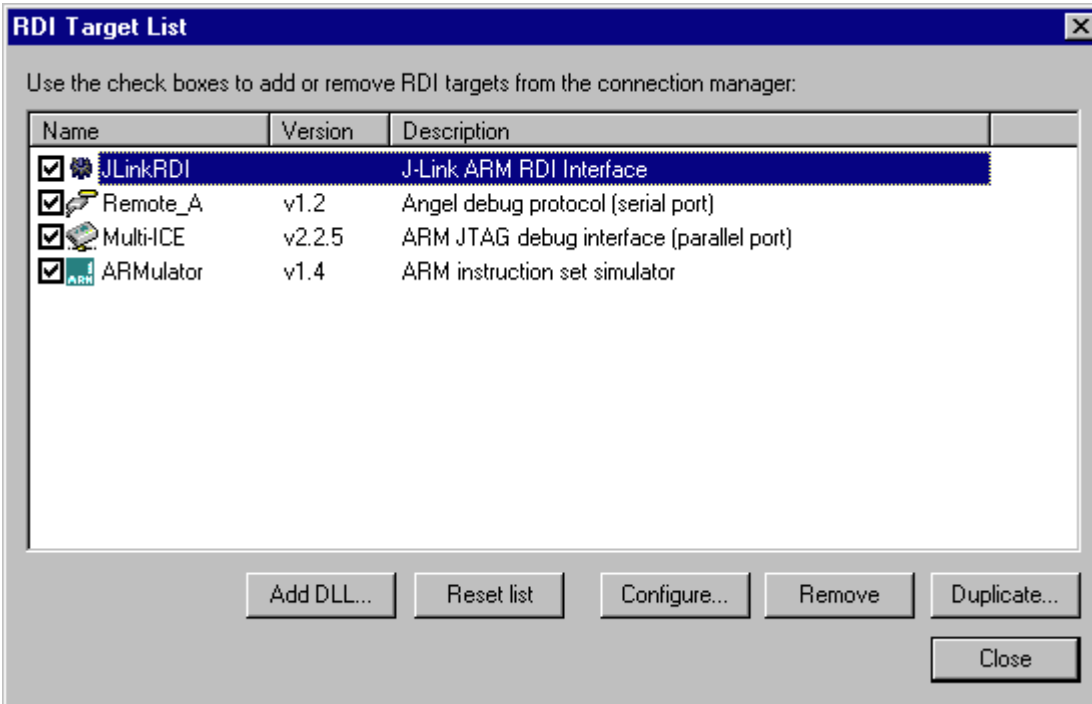

7. Click the **OK** button in the configuration dialog. Now close the **RDI Target List** dialog. Make sure your target hardware is already connected to J-Link.
8. In the **Connection control** dialog, expand the **JLink ARM RDI Interface** and select the ARM_0 Processor. Close the **Connection Control** Window.

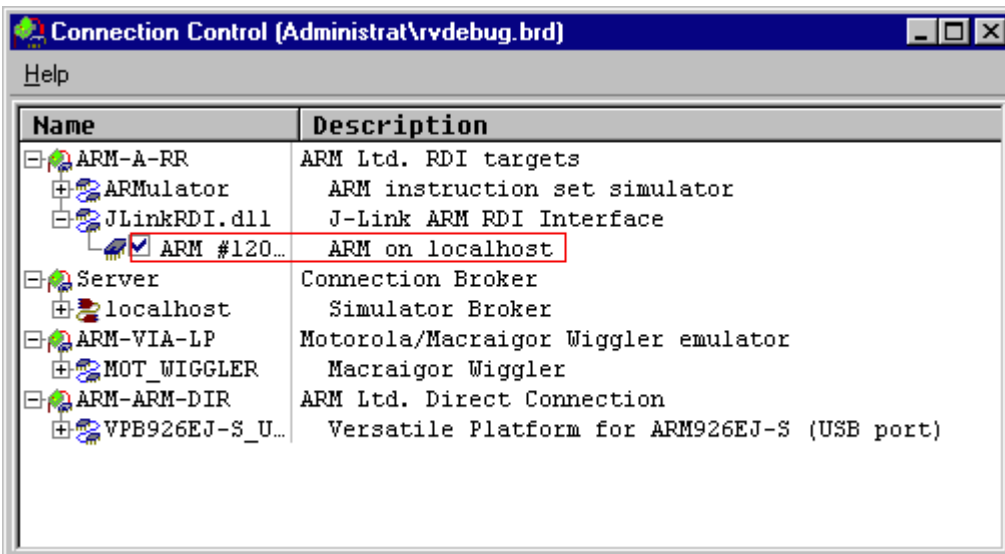

9. Now the RealView Debugger is connected to J-Link.

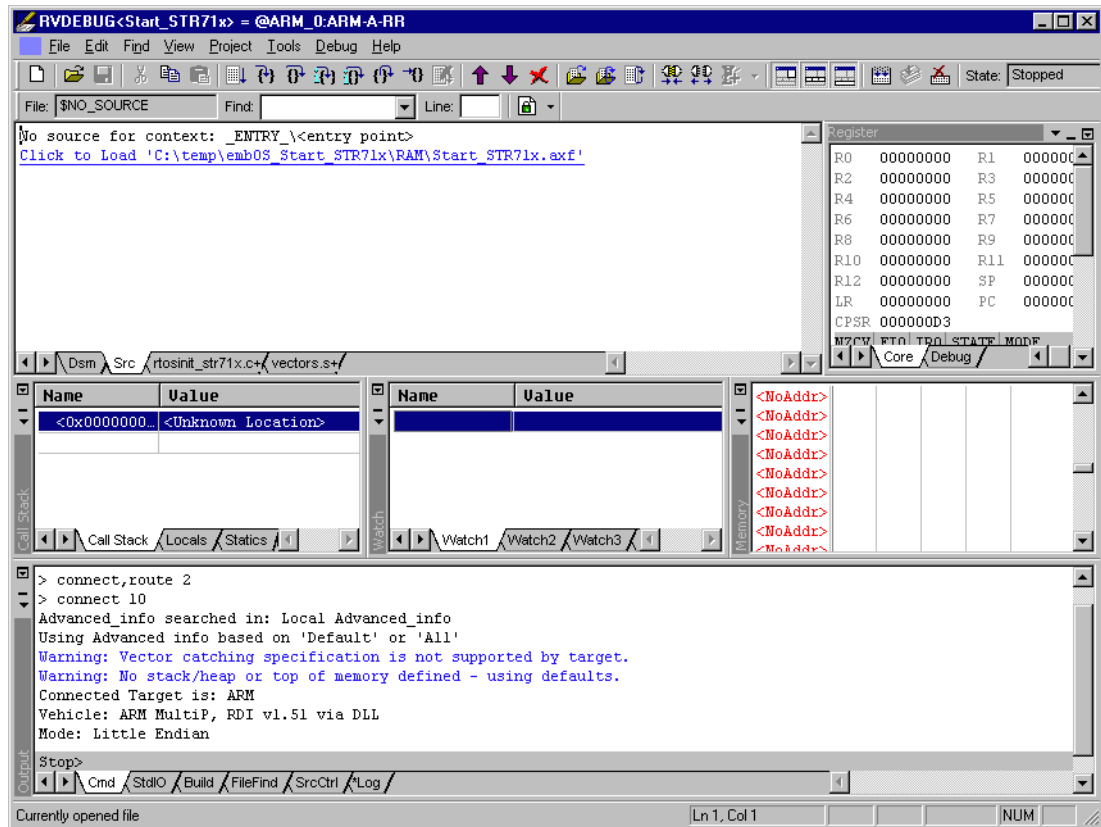

10. A project or an image is needed for debugging. After downloading, J-Link is used to debug the target.

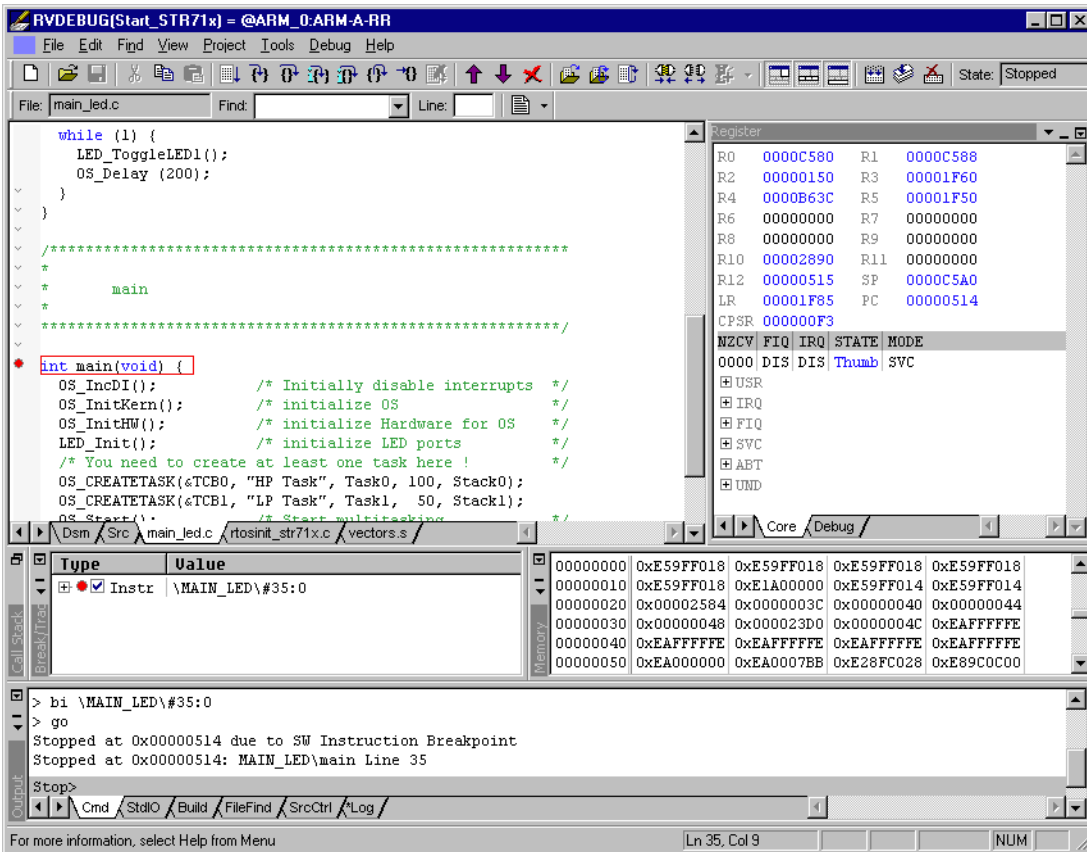

12.3.4 GHS MULTI

12.3.4.1 Software version

J-Link RDI has been tested with GHS MULTI version 4.07. There should be no problems with other versions of GHS MULTI. All screenshots are taken from GHS MULTI version 4.07.

12.3.4.2 Configuring to use J-Link RDI

1. Start Green Hills Software MULTI integrated development environment. Click **Connect | Connection Organizer** to open the **Connection Organizer**.

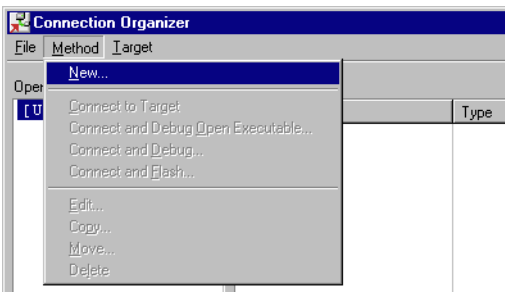

- Click **Method | New** in the **Connection Organizer** dialog.

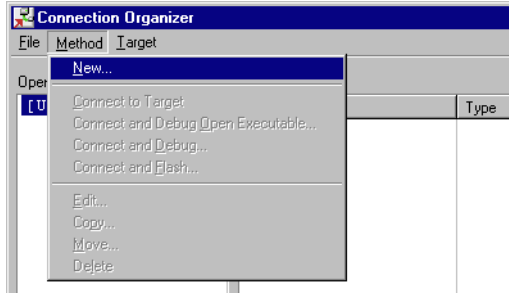

- The **Create a new Connection Method** will be opened. Enter a name for your configuration in the **Name** field and select **Custom** in the **Type** list. Confirm your choice with the **Create...** button.

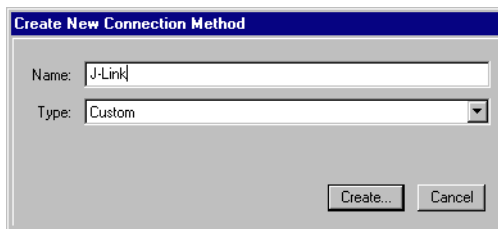

- The **Connection Editor** dialog will be opened. Enter **rdiserv** in the **Server** field and enter the following values in the **Arguments** field:

```
-config -dll <FullPathToJLinkDLLs>
```

Note that `JLinkRDI.dll` and `JLinkARM.dll` must be stored in the same directory. If the standard J-Link installation path or another path that includes spaces has been used, enclose the path in quotation marks.

Example:

```
-config -dll "C:\Program Files\SEGGER\JLinkARM_V350g\JLinkRDI.dll"
```

Refer to GHS manual "MULTI: Configuring Connections for ARM Targets", chapter "ARM Remote Debug Interface (rdiserv) Connections" for a complete list of possible arguments.

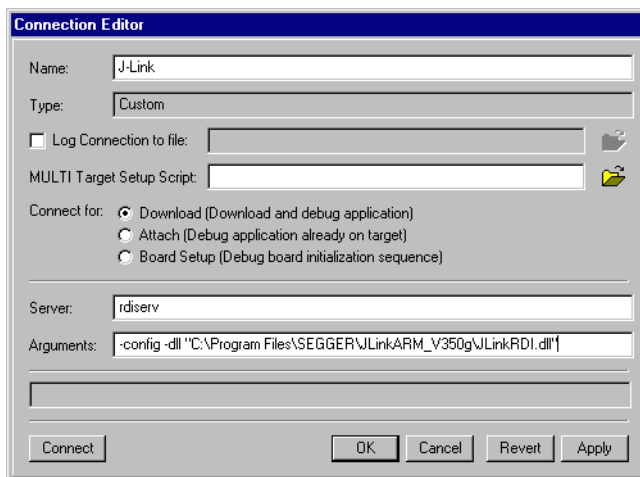

5. Confirm the choices by clicking the **Apply** button after the **Connect** button.

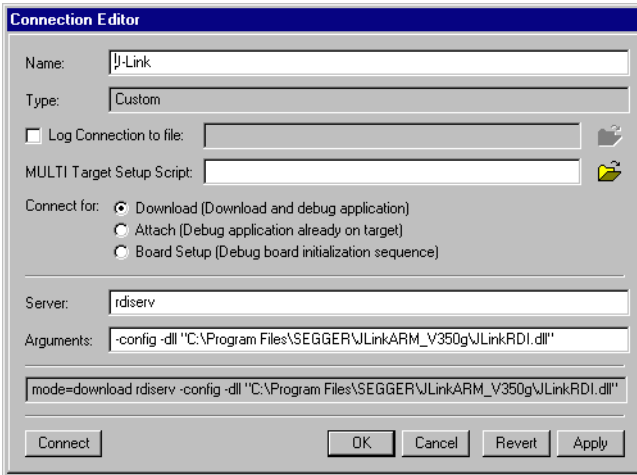

6. The **J-Link RDI Configuration** dialog will open. For more information about the generic setup of J-Link RDI, please refer to *Configuration* on page 354.
7. Click the **OK** button to connect to the target. Build the project and start the debugger. Note that at least one action (for example **step** or **run**) has to be performed in order to initiate the download of the application.

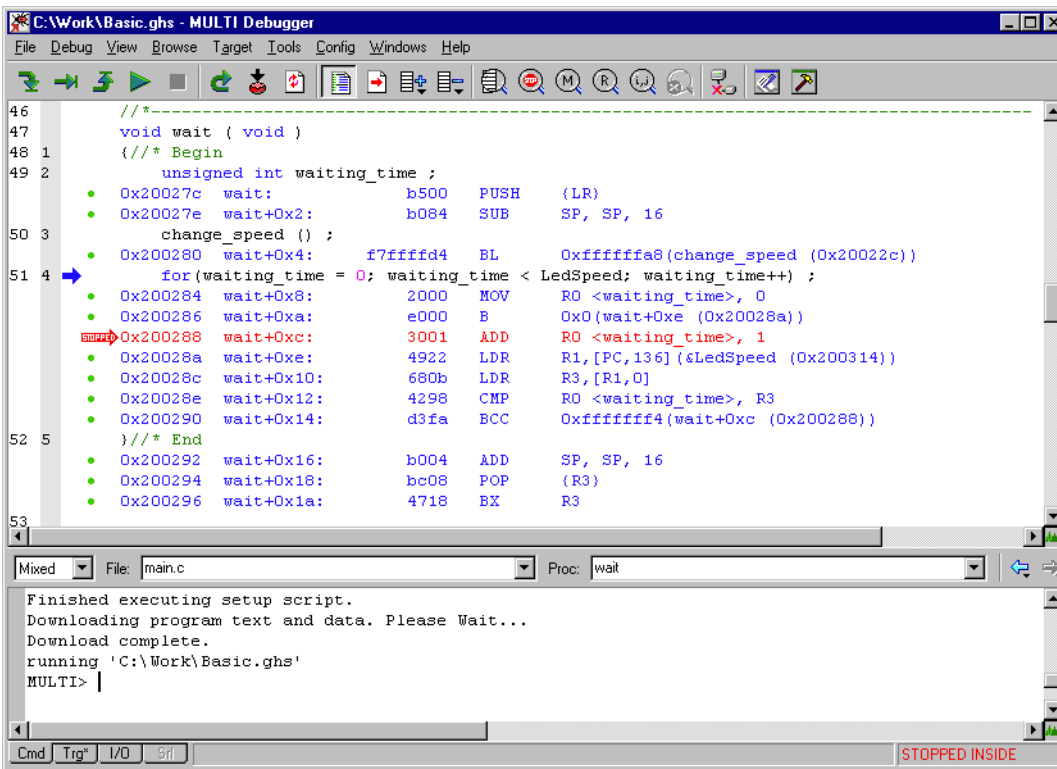

12.3.5 KEIL MDK (μ Vision IDE)

12.3.5.1 Software version

J-Link has been tested with KEIL MDK 3.34. There should be no problems with other versions of KEIL μ Vision. All screenshots are taken from MDK 3.34.

12.3.5.2 Configuring to use J-Link RDI

Start KEIL μ Vision and open the project.

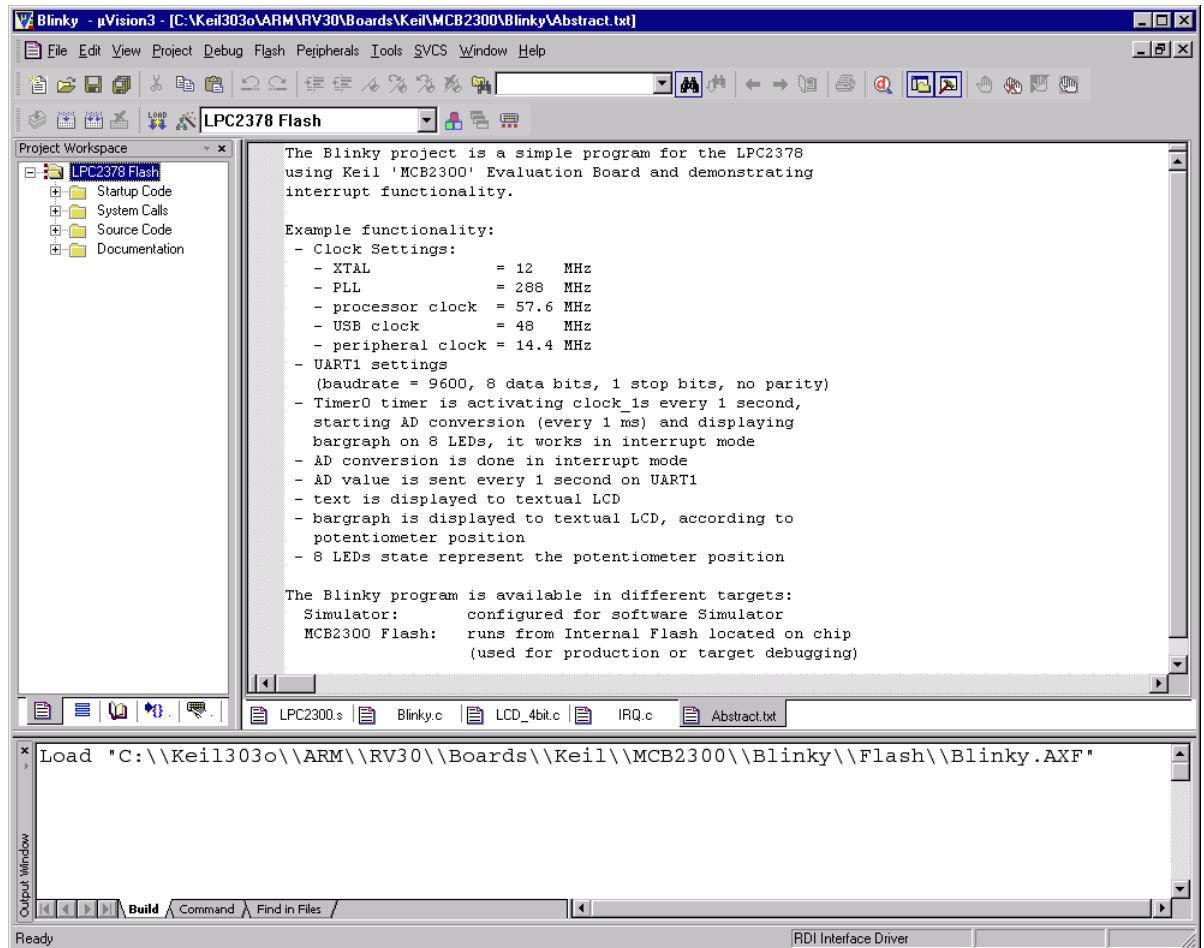

Select **Project | Options for Target '<NameOfTarget>'** to open the project options dialog and select the **Debug** tab.

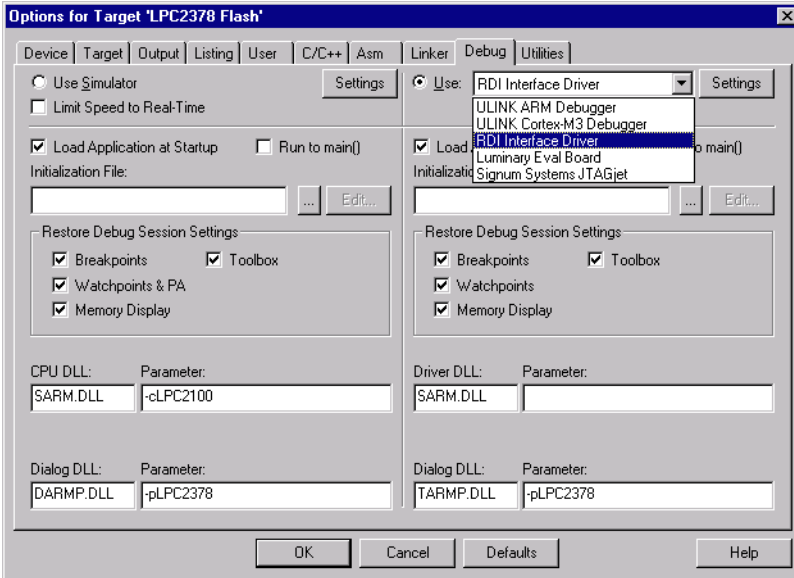

Choose **RDI Interface Driver** from the list as shown above and click the **Settings** button. Select the location of JLinkRDI.dll in **Browse for RDI Driver DLL** field, and click the **Configure RDI Driver** button.

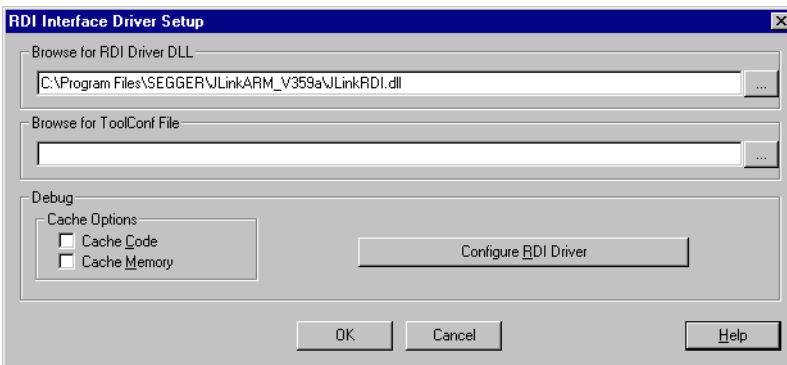

The J-Link RDI Configuration dialog will be opened. For more information about the generic setup of J-Link RDI, please refer to *Configuration* on page 354.

After finishing configuration, the project can be built (**Project | Build Target**) and the debugger can be started (**Debug | Start/Stop debug session**).

The screenshot shows the Keil uVision3 Disassembly window for a project named 'Blinky - μVision3 - [Disassembly]'. The interface includes a menu bar, a toolbar, and several windows:

- Register Window:** Shows the current state of registers R0 through R15, CPSR, and SPSR. All registers are at 0x00000000.
- Disassembly Window:** Displays assembly code for the vector table. The code starts at address 0x00000000 and includes instructions for loading reset, undefined, SWI, and other handler addresses into the PC register. It also shows DCD instructions for defining handler addresses like Reset_Handler, Undefined_Handler, SWI_Handler, etc.
- Memory Window:** Shows memory contents starting at address 0x3FFFC000. The memory contains values 00000000 and 600000DF.
- Output Window:** Shows the command 'ASSIGN BreakDisable BreakEnable BreakKill'.

The disassembly code is as follows:

```

332: Vectors          LDR    PC, Reset_Addr
0x00000000 E59FF018 LDR    PC,[PC,#0x0018]
333:                  LDR    PC, Undef_Addr
0x00000004 E59FF018 LDR    PC,[PC,#0x0018]
334:                  LDR    PC, SWI_Addr
0x00000008 E59FF018 LDR    PC,[PC,#0x0018]
335:                  LDR    PC, PAbt_Addr
0x0000000C E59FF018 LDR    PC,[PC,#0x0018]
336:                  LDR    PC, DAbt_Addr
0x00000010 E59FF018 LDR    PC,[PC,#0x0018]
337:                  NOP
338: ;                  LDR    PC, IRQ_Addr
0x00000014 B9206E50 STMLTDB R0!,{R4,R6,R9-R11,R13-R14}
339:                  LDR    PC, [PC, #-0x0120] ; Vector from UicVectAddr
0x00000018 E51FF120 LDR    PC,[PC,#-0x0120]
340:                  LDR    PC, FIQ_Addr
341:
342: Reset_Addr       DCD    Reset_Handler
343: Undef_Addr       DCD    Undefined_Handler
344: SWI_Addr         DCD    SWI_Handler
345: PAbt_Addr        DCD    PAbt_Handler
346: DAbt_Addr        DCD    DAbt_Handler
347:                  DCD    0 ; Reserved Address
348: IRQ_Addr         DCD    IRQ_Handler
349: FIQ_Addr         DCD    FIQ_Handler
  
```

12.4 Configuration

This section describes the generic setup of J-Link RDI (same for all debuggers) using the J-Link RDI configuration dialog.

12.4.1 Configuration file JLinkRDI.ini

All settings are stored in the file `JLinkRDI.ini`. This file is located in the same directory as `JLinkRDI.dll`.

12.4.2 Using different configurations

It can be desirable to use different configurations for different targets. If this is the case, a new folder needs to be created and the `JLinkARM.dll` as well as the `JLinkRDI.dll` needs to be copied into it.

Project A needs to be configured to use `JLinkRDI.dll` A in the first folder, project B needs to be configured to use the DLL in the second folder. Both projects will use separate configuration files, stored in the same directory as the DLLs they are using.

If the debugger allows using a project-relative path (such as IAR EWARM: Use for example `$PROJ_DIR$\RDI\`), it can make sense to create the directory for the DLLs and configuration file in a subdirectory of the project.

12.4.3 Using multiple J-Links simultaneously

Same procedure as using different configurations. Each debugger session will use their own instance of the `JLinkRDI.dll`.

12.4.4 Configuration dialog

The configuration dialog consists of several tabs making the configuration of J-Link RDI very easy.

12.4.4.1 General tab



Connection to J-Link

This setting allows the user to configure how the DLL should connect to the J-Link. Some J-Link models also come with an Ethernet interface which allows to use an emulator remotely via TCP/IP connection.

License (J-Link RDI License management)

1. The **License** button opens the **J-Link RDI License management** dialog. J-Link RDI requires a valid license.

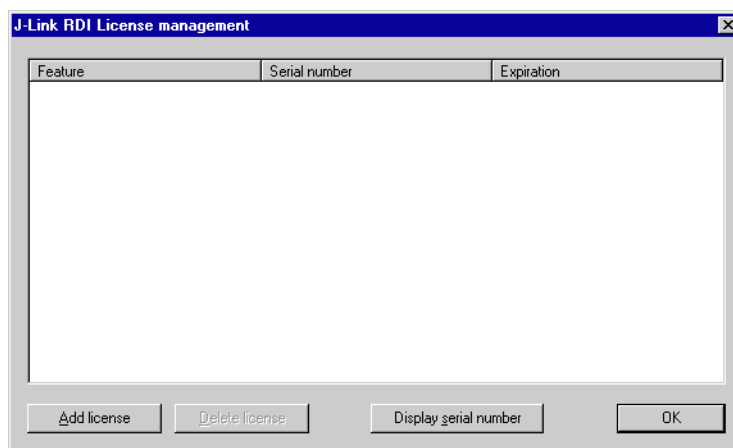

2. Click the **Add license** button and enter your license. Confirm your input by click-

ing the **OK** button.

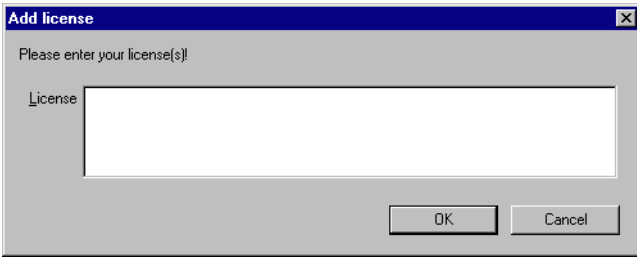

3. The J-Link RDI license is now added.

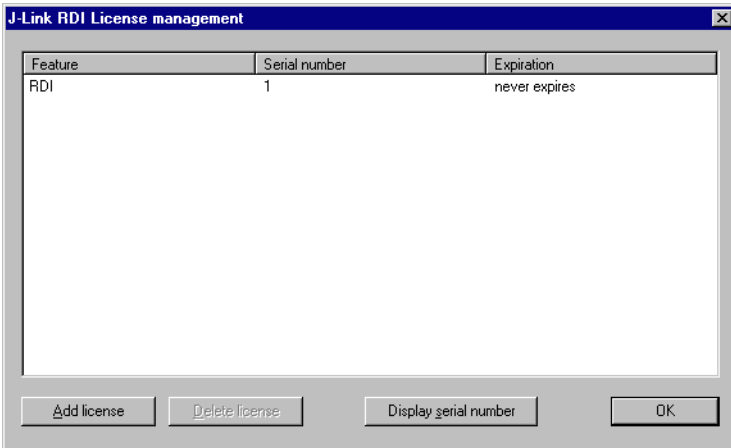

12.4.4.2 Init tab



Macro file

A macro file can be specified to load custom settings to configure J-Link RDI with advanced commands for special chips or operations. For example, a macro file can be used to initialize a target to use the PLL before the target application is downloaded, in order to speed up the download.

Comands in the macro file

Command	Description
SetJTAGSpeed(x);	Sets the JTAG speed, x = speed in kHz (0=Auto)
Delay(x);	Waits a given time, x = delay in milliseconds
Reset(x);	Resets the target, x = delay in milliseconds
Go();	Starts the ARM core
Halt();	Halts the ARM core
Read8(Addr);	Reads a 8/16/32 bit value, Addr = address to read (as hex value)
Read16(Addr);	
Read32(Addr);	
Verify8(Addr, Data);	Verifies a 8/16/32 bit value, Addr = address to verify (as hex value) Data = data to verify (as hex value)
Verify16(Addr, Data);	
Verify32(Addr, Data);	
Write8(Addr, Data);	Writes a 8/16/32 bit value, Addr = address to write (as hex value) Data = data to write (as hex value)
Write16(Addr, Data);	
Write32(Addr, Data);	
WriteVerify8(Addr, Data);	Writes and verifies a 8/16/32 bit value, Addr = address to write (as hex value) Data = data to write (as hex value)
WriteVerify16(Addr, Data);	
WriteVerify32(Addr, Data);	
WriteRegister(Reg, Data);	Writes a register
WriteJTAG_IR(Cmd);	Writes the JTAG instruction register
WriteJTAG_DR(nBits, Data);	Writes the JTAG data register

Table 12.2: Macro file commands

Example of macro file

```

/*****
*
*   Macro file for J-LINK RDI
*
*****
* File:    LPC2294.setup
* Purpose: Setup for Philips LPC2294 chip
*****
*/
SetJTAGSpeed(1000);
Reset(0);
Write32(0xE01FC040, 0x00000001); // Map User Flash into Vector area at (0-3f)
Write32(0xFFE00000, 0x20003CE3); // Setup CS0
Write32(0xE002C014, 0x0E6001E4); // Setup PINSEL2 Register
SetJTAGSpeed(2000);

```

12.4.4.3 JTAG tab

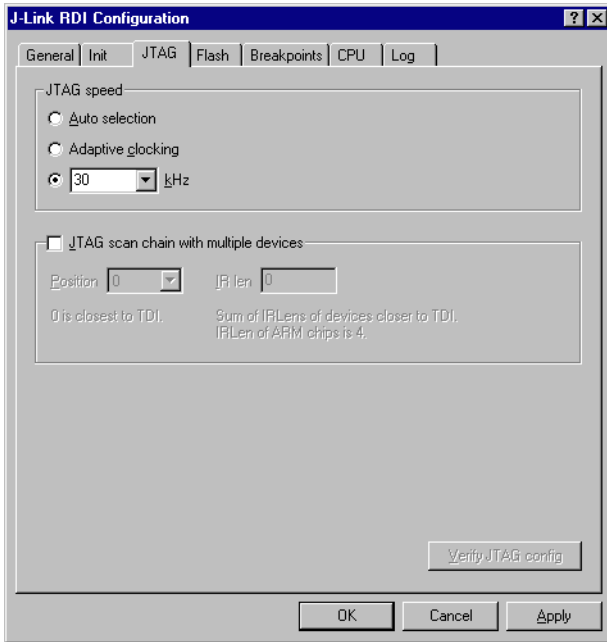

JTAG speed

This allows the selection of the JTAG speed. There are basically three types of speed settings (which are explained below):

- Fixed JTAG speed
- Automatic JTAG speed
- Adaptive clocking

For more information about the different speed settings supported by J-Link, please refer to *JTAG Speed* on page 194.

JTAG scan chain with multiple devices

The JTAG scan chain allows to specify the instruction register organization of the target system. This may be needed if there are more devices located on the target system than the ARM chip you want to access or if more than one target system is connected to one J-Link at once.

12.4.4.4 Flash tab

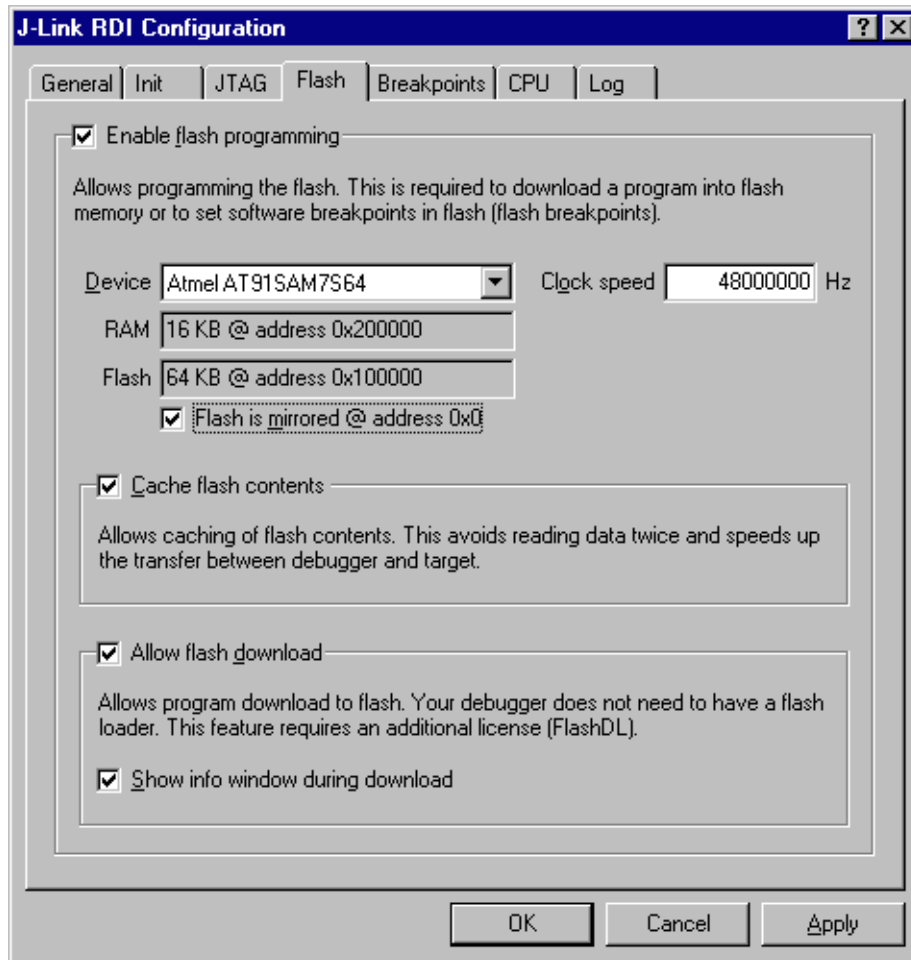

Enable flash programming

This checkbox enables flash programming. Flash programming is needed to use either flash download or flash breakpoints.

If flash programming is enabled you must select the correct flash memory and flash base address. Furthermore it is necessary for some chips to enter the correct CPU clock frequency.

Cache flash contents

If enabled, the flash content is cached by the J-Link RDI software to avoid reading data twice and to speed up the transfer between debugger and target.

Allow flash download

This allows the J-Link RDI software to download program into flash. A small piece of code will be downloaded and executed in the target RAM which then programs the flash memory. This provides flash loading abilities even for debuggers without a build-in flash loader.

An info window can be shown during download displaying the current operation. Depending on your JTAG speed you may see the info window only very short.

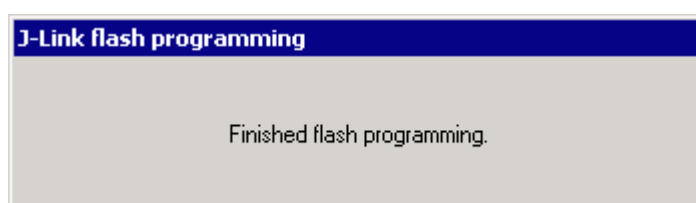

12.4.4.5 Breakpoints tab

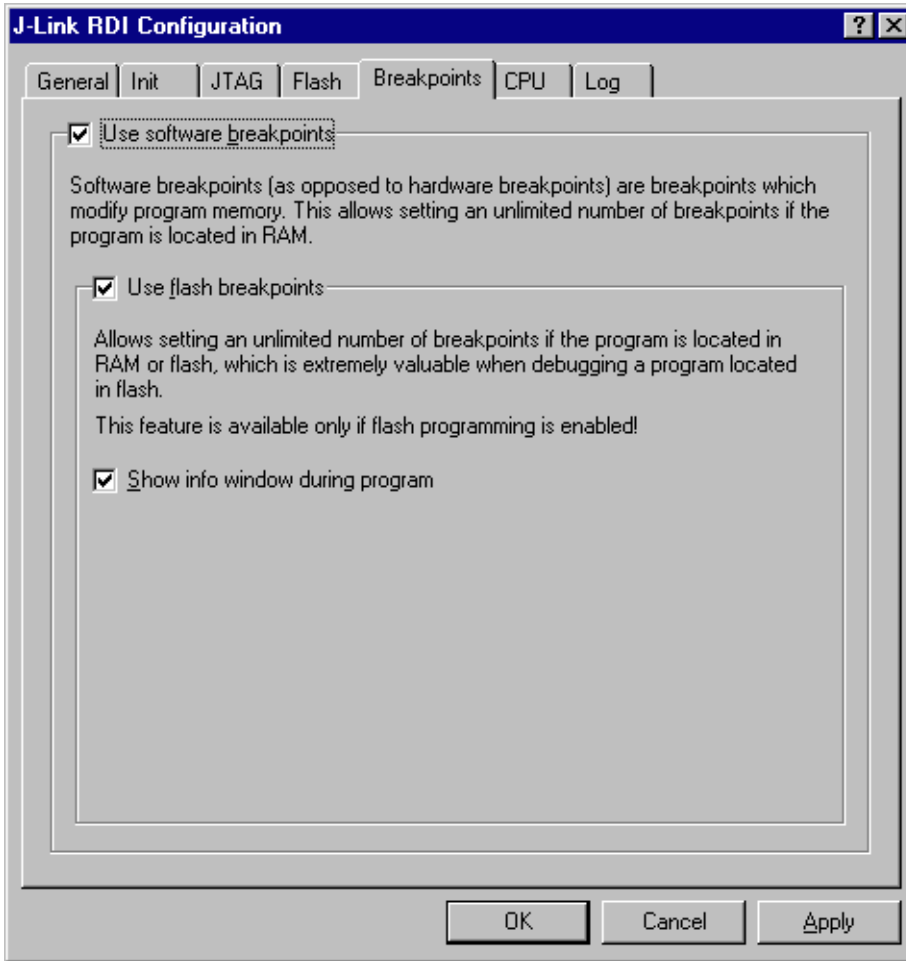

Use software breakpoints

This allows to set an unlimited number of breakpoints if the program is located in RAM by setting and resetting breakpoints according to program code.

Use flash breakpoints

This allows to set an unlimited number of breakpoints if the program is located either in RAM or in flash by setting and resetting breakpoints according to program code.

An info window can be displayed while flash breakpoints are used showing the current operation. Depending on your JTAG speed the info window may hardly to be seen.

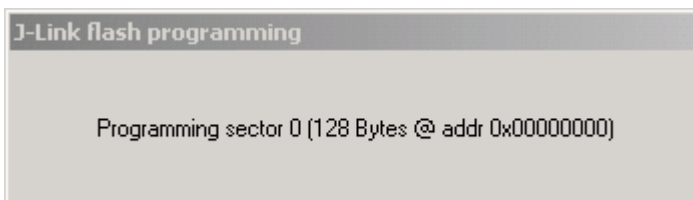

12.4.4.6 CPU tab

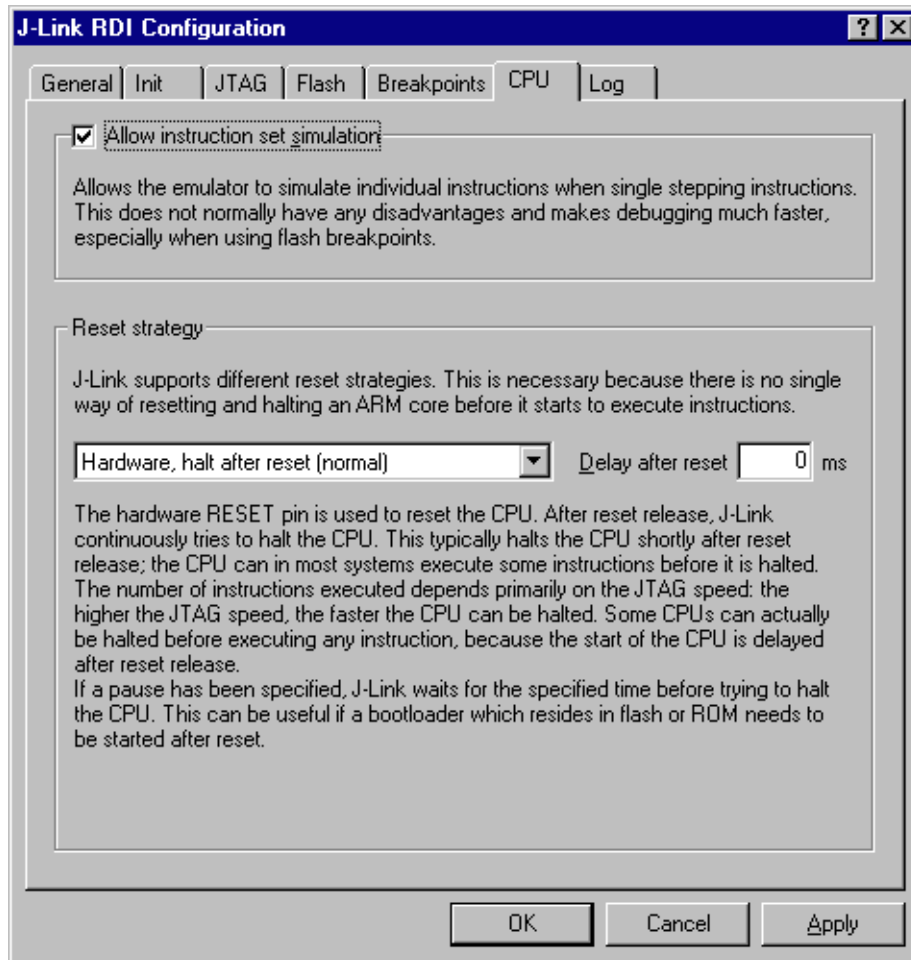

Instruction set simulation

This enables instruction set simulation which speeds up single stepping instructions especially when using flash breakpoints.

Reset strategy

This defines the way J-Link RDI should handle resets called by software.

J-Link supports different reset strategies. This is necessary because there is no single way of resetting and halting an ARM core before it starts to execute instructions.

For more information about the different reset strategies which are supported by J-Link and why different reset strategies are necessary, please refer to *Reset strategies* on page 209.

12.4.4.7 Log tab

A log file can be generated for the J-Link DLL and for the J-Link RDI DLL. This log files may be useful for debugging and evaluating. They may help you to solve a problem yourself, but is also needed by customer support help you.

Default path of the J-Link log file: `c:\JLinkARM.log`

Default path of the J-Link RDI log file: `c:\JLinkRDI.log`

Example of logfile content:

```

060:028 (0000) Logging started @ 2005-10-28 07:36
060:028 (0000) DLL Compiled: Oct  4 2005 09:14:54
060:031 (0026) ARM_SetMaxSpeed - Testing speed 3F0F0F0F 3F0F0F0F 3F0F0F0F 3F0F0F0F
3F0F0F0F 3F0F0F0F 3F0F0F0F 3F0F0F0F 3F0F0F0F 3F0F0F0F 3F0F0F0F 3F0F0F0FAuto JTAG
speed: 4000 kHz
060:059 (0000) ARM_SetEndian(ARM_ENDIAN_LITTLE)
060:060 (0000) ARM_SetEndian(ARM_ENDIAN_LITTLE)
060:060 (0000) ARM_ResetPullsRESET(ON)
060:060 (0116) ARM_Reset(): SpeedIsFixed == 0 -> JTAGSpeed = 30kHz >48> >2EF>
060:176 (0000) ARM_WriteIceReg(0x02,00000000)
060:177 (0016) ARM_WriteMem(FFFFFC20,0004) -- Data:  01 06 00 00 - Writing 0x4 bytes
@ 0xFFFFFC20 >1D7>
060:194 (0014) ARM_WriteMem(FFFFFC2C,0004) -- Data:  05 1C 19 00 - Writing 0x4 bytes
@ 0xFFFFFC2C >195>
060:208 (0015) ARM_WriteMem(FFFFFC30,0004) -- Data:  07 00 00 00 - Writing 0x4 bytes
@ 0xFFFFFC30 >195>
060:223 (0002) ARM_ReadMem (00000000,0004)JTAG speed: 4000 kHz -- Data:  0C 00 00 EA
060:225 (0001) ARM_WriteMem(00000000,0004) -- Data:  0D 00 00 EA - Writing 0x4 bytes
@ 0x00000000 >195>
060:226 (0001) ARM_ReadMem (00000000,0004) -- Data:  0C 00 00 EA
060:227 (0001) ARM_WriteMem(FFFFFFF0,0004) -- Data:  01 00 00 00 - Writing 0x4 bytes
@ 0xFFFFF000 >195>
060:228 (0001) ARM_ReadMem (FFFFF240,0004) -- Data:  40 05 09 27
060:229 (0001) ARM_ReadMem (FFFFF244,0004) -- Data:  00 00 00 00
060:230 (0001) ARM_ReadMem (FFFFF6C,0004) -- Data:  10 01 00 00
060:232 (0000) ARM_WriteMem(FFFFF124,0004) -- Data:  FF FF FF FF - Writing 0x4 bytes
@ 0xFFFFF124 >195>
060:232 (0001) ARM_ReadMem (FFFFF130,0004) -- Data:  00 00 00 00
060:233 (0001) ARM_ReadMem (FFFFF130,0004) -- Data:  00 00 00 00
060:234 (0001) ARM_ReadMem (FFFFF130,0004) -- Data:  00 00 00 00
060:236 (0000) ARM_ReadMem (FFFFF130,0004) -- Data:  00 00 00 00
060:237 (0000) ARM_ReadMem (FFFFF130,0004) -- Data:  00 00 00 00
060:238 (0001) ARM_ReadMem (FFFFF130,0004) -- Data:  00 00 00 00
060:239 (0001) ARM_ReadMem (FFFFF130,0004) -- Data:  00 00 00 00
060:240 (0001) ARM_ReadMem (FFFFF130,0004) -- Data:  00 00 00 00
060:241 (0001) ARM_WriteMem(FFFFFD44,0004) -- Data:  00 80 00 00 - Writing 0x4 bytes
@ 0xFFFFFD44 >195>
060:277 (0000) ARM_WriteMem(00000000,0178) -- Data:  0F 00 00 EA FE FF FF EA ...
060:277 (0000) ARM_WriteMem(000003C4,0020) -- Data:  01 00 00 00 02 00 00 00 ... -
Writing 0x178 bytes @ 0x00000000
060:277 (0000) ARM_WriteMem(000001CC,00F4) -- Data:  30 B5 15 48 01 68 82 68 ... -
Writing 0x20 bytes @ 0x000003C4
060:277 (0000) ARM_WriteMem(000002C0,0002) -- Data:  00 47
060:278 (0000) ARM_WriteMem(000002C4,0068) -- Data:  F0 B5 00 27 24 4C 34 4D ... -
Writing 0xF6 bytes @ 0x000001CC
060:278 (0000) ARM_WriteMem(0000032C,0002) -- Data:  00 47
060:278 (0000) ARM_WriteMem(00000330,0074) -- Data:  30 B5 00 24 A0 00 08 49 ... -
Writing 0x6A bytes @ 0x000002C4
060:278 (0000) ARM_WriteMem(000003B0,0014) -- Data:  00 00 00 00 0A 00 00 00 ... -
Writing 0x74 bytes @ 0x00000330
060:278 (0000) ARM_WriteMem(000003A4,000C) -- Data:  14 00 00 00 E4 03 00 00 ... -
Writing 0x14 bytes @ 0x000003B0
060:278 (0000) ARM_WriteMem(00000178,0054) -- Data:  12 4A 13 48 70 B4 81 B0 ... -
Writing 0xC bytes @ 0x000003A4
060:278 (0000) ARM_SetEndian(ARM_ENDIAN_LITTLE)
060:278 (0000) ARM_SetEndian(ARM_ENDIAN_LITTLE)
060:278 (0000) ARM_ResetPullsRESET(OFF)
060:278 (0009) ARM_Reset(): - Writing 0x54 bytes @ 0x00000178 >3E68>
060:287 (0001) ARM_Halt(): **** Warning: Chip has already been halted.
...

```

12.5 Semihosting

Semihosting can be used with J-Link RDI. For more information how to enable semihosting in J-Link RDI, please refer to *Enabling Semihosting in J-Link RDI + AXD* on page 464.

12.5.1 Unexpected / unhandled SWIs

When an unhandled SWI is detected by J-Link RDI, the message box below is shown.

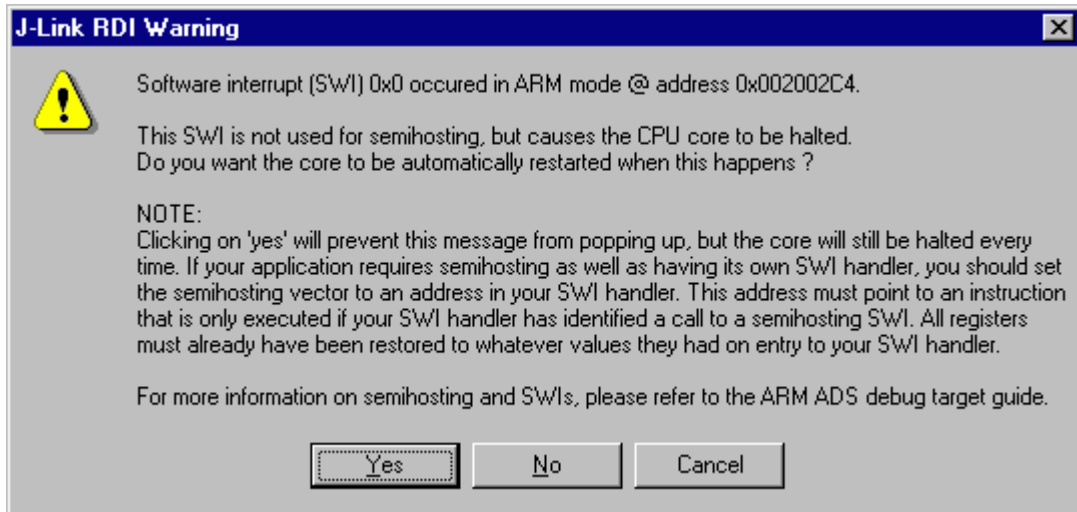

Chapter 13

RTT

SEGGER's Real Time Terminal (RTT) is a technology for interactive user I/O in embedded applications. It combines the advantages of SWO and semihosting at very high performance.

13.1 Introduction

With RTT it is possible to output information from the target microcontroller as well as sending input to the application at a very high speed without affecting the target's real time behavior.

SEGGER RTT can be used with any J-Link model and any supported target processor which allows background memory access, which are Cortex-M and RX targets.

RTT supports multiple channels in both directions, up to the host and down to the target, which can be used for different purposes and provide the most possible freedom to the user.

The default implementation uses one channel per direction, which are meant for printable terminal input and output. With the J-Link RTT Viewer this channel can be used for multiple "virtual" terminals, allowing to print to multiple windows (e.g. one for standard output, one for error output, one for debugging output) with just one target buffer. An additional up (to host) channel can for example be used to send profiling or event tracing data.

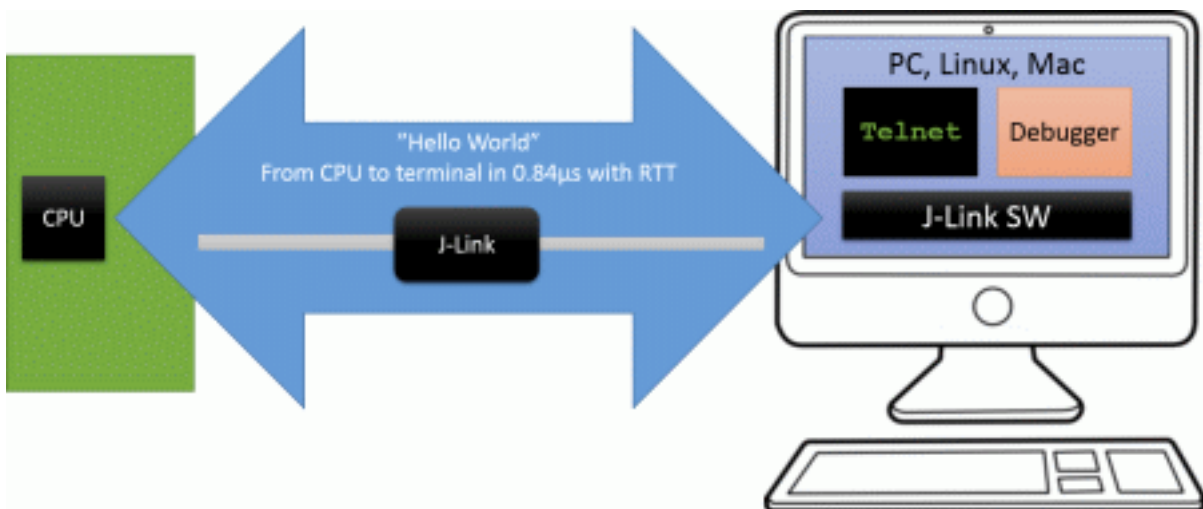

13.2 How RTT works

13.2.1 Target implementation

Real Time Terminal uses a SEGGER RTT Control Block structure in the target's memory to manage data reads and writes.

The control block contains an ID to make it findable in memory by a connected J-Link and a ring buffer structure for each available channel, describing the channel buffer and its state.

The maximum number of available channels can be configured at compile time and each buffer can be configured and added by the application at run time. Up and down buffers can be handled separately.

Each channel can be configured to be blocking or non-blocking. In blocking mode the application will wait when the buffer is full, until all memory could be written, resulting in a blocked application state but preventing data from getting lost. In non-blocking mode only data which fits into the buffer, or none at all, will be written and the rest will be discarded. This allows running in real-time, even when no debugger is connected. The developer does not have to create a special debug version and the code can stay in place in a release application.

13.2.2 Locating the Control Block

When RTT is active on the host computer, either by using RTT directly via an application like RTT Viewer or by connecting via Telnet to an application which is using J-Link, like a debugger, J-Link automatically searches for the SEGGER RTT Control Block in the target's known RAM regions. The RAM regions or the specific address of the Control Block can also be set via the host applications to speed up detection or if the block cannot be found automatically.

13.2.2.1 Manual specification of the Control Block location

While auto-detection of the RTT control block location works fine for most targets, it is always possible to manually specify either the exact location of the control block or to specify a certain address range J-Link shall search for a control block for in. This is done via the following command strings:

- *SetRTTAddr* on page 247
- *SetRTTSearchRanges* on page 247

For more information about how to use J-Link command strings in various environments, please refer to *Using command strings* on page 251

13.2.3 Internal structures

There may be any number of "Up Buffer Descriptors" (Target -> Host), as well as any number of "Down Buffer Descriptors" (Host -> Target). Each buffer size can be configured individually.

The gray areas in the buffers are the areas that contain valid data.

For Up buffers, the Write Pointer is written by the target, the Read Pointer is written by the debug probe (J-Link, Host).

When Read and Write Pointers point to the same element, the buffer is empty. This assures there is never a race condition. The image shows the simplified structure in the target.

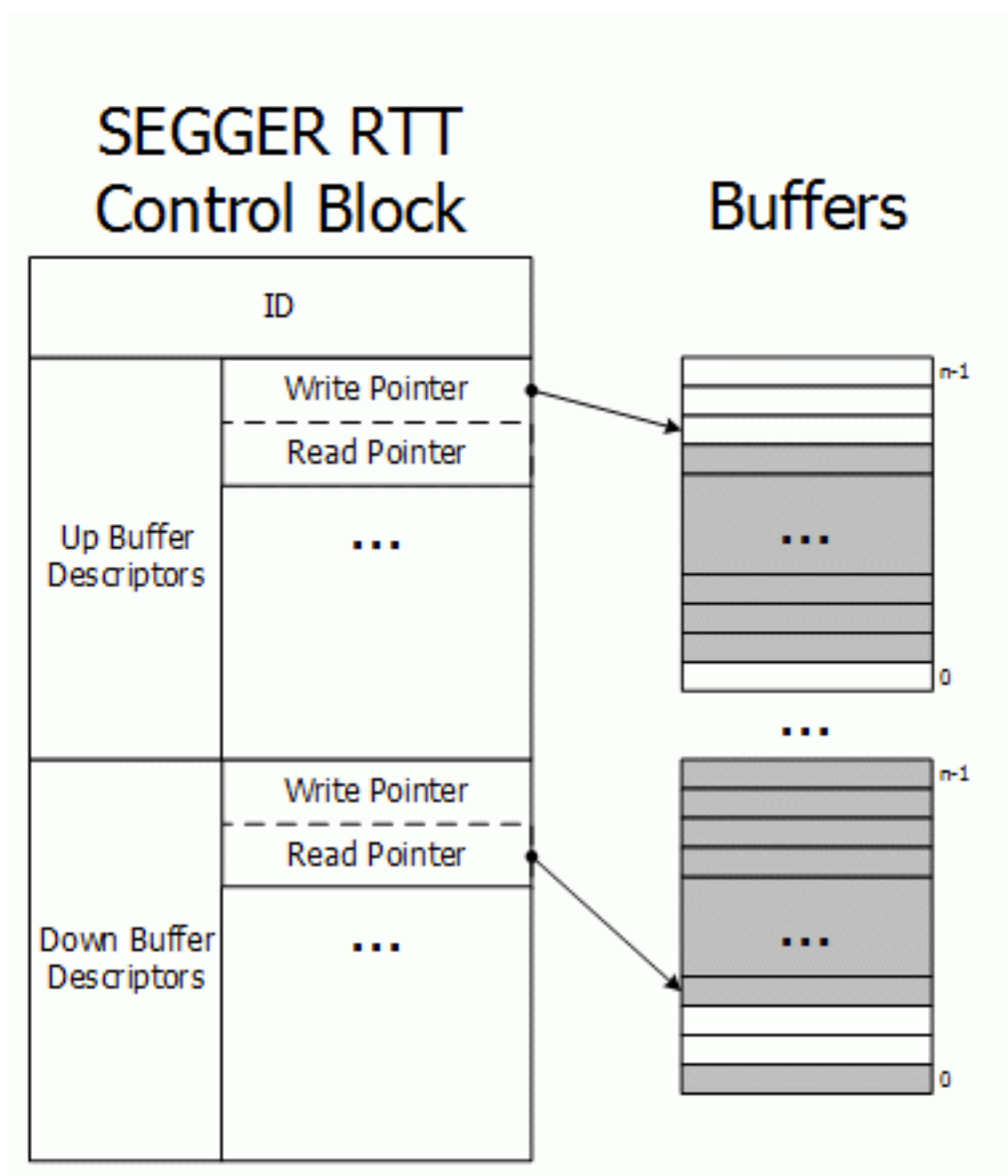

13.2.4 Requirements

SEGGER RTT does not need any additional pin or hardware, despite a J-Link connected via the standard debug port to the target. It does not require any configuration of the target or in the debugging environment and can even be used with varying target speeds.

RTT can be used in parallel to a running debug session, without intrusion, as well as without any IDE or debugger at all.

13.2.5 Performance

The performance of SEGGER RTT is significantly higher than any other technology used to output data to a host PC. An average line of text can be output in one micro-second or less. Basically only the time to do a single memcpy().

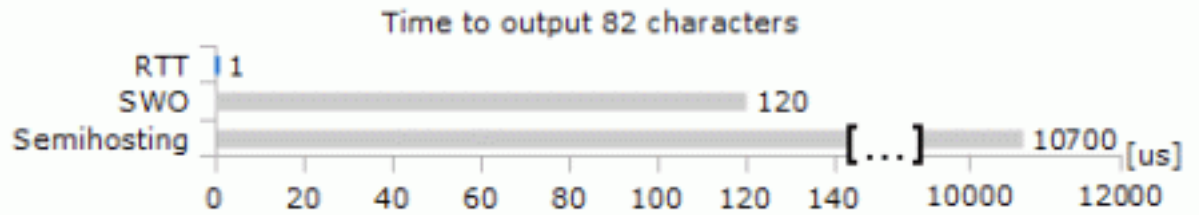

13.2.6 Memory footprint

The RTT implementation code uses ~500 Bytes of ROM and 24 Bytes ID + 24 Bytes per channel for the control block in RAM. Each channel requires some memory for the buffer. The recommended sizes are 1 kByte for up channels and 16 to 32 Bytes for down channels depending on the load of in- / output.

13.3 RTT Communication

Communication with the RTT implementation on the target can be done with different applications. The functionality can even be integrated into custom applications using the J-Link SDK.

Using RTT in the target application is made easy. The implementation code is freely available for download and can be integrated into any existing application. To communicate via RTT any J-Link can be used.

The simple way to communicate via the Terminal (Channel 0) is to create a connection to localhost:19021 with a Telnet client or similar, when a connection to J-Link (e.g. via a debug session) is active.

The J-Link Software Package comes with some more advanced applications, which demonstrates RTT functionality for different purposes.

13.3.1 RTT Viewer

The J-Link RTT Viewer is described in [J-Link RTT Viewer](#).

13.3.2 RTT Client

J-Link RTT Client acts as a Telnet client, but automatically tries to reconnect to a J-Link connection when a debug session is closed.

The J-Link RTT Client is part of the J-Link Software and Documentation Pack for Windows, Linux and OS X and can be used for simple RTT use cases.

13.3.3 RTT Logger

With J-Link RTT Logger, data from Up-Channel 1 can be read and logged to a file. This channel can for example be used to send performance analysis data to the host.

J-Link RTT Logger opens a dedicated connection to J-Link and can be used stand-alone, without running a debugger.

The application is part of the J-Link Software and Documentation Pack for Windows, Linux and OS X.

The source of J-Link RTT Logger can be used as a starting point to integrate RTT in other PC applications, like debuggers, and is part of the J-Link SDK.

13.3.4 RTT in other host applications

RTT can also be integrated in any other PC application like a debugger or a data visualizer in either of two ways.

1. The application can establish a socket connection to the RTT Telnet Server which is opened on localhost:19021 when a J-Link connection is active.
2. The application creates its own connection to J-Link and uses the J-Link RTT API which is part of the J-Link SDK to directly configure and use RTT.

13.4 Implementation

The SEGGER RTT implementation code is written in ANSI C and can be integrated into any embedded application by simply adding the available sources.

RTT can be used via a simple and easy to use API. It is even possible to override the standard printf() functions to be used with RTT. Using RTT reduces the time taken for output to a minimum and allows printing debug information to the host computer while the application is performing time critical real time tasks.

The implementation code also includes a simple version of printf() which can be used to write formatted strings via RTT. It is smaller than most standard library printf() implementations and does not require heap and only a configurable amount of stack.

The SEGGER RTT implementation is fully configurable at compile time with pre-processor defines. The number of channels, the size of the default channels can be set. Reading and writing can be made task-safe with definable Lock() and Unlock() routines.

13.4.1 API functions

The following API functions are available in the RTT Implementation. To use them SEGGER_RTT.h has to be included in the calling sources.

13.4.1.1 SEGGER_RTT_ConfigDownBuffer()

Description

Configure or add a down buffer by specifying its name, size and flags.

Prototype

```
int SEGGER_RTT_ConfigDownBuffer (unsigned BufferIndex, const char* sName,
char* pBuffer, int BufferSize, int Flags);
```

Parameters

Parameter	Meaning
BufferIndex	Index of the buffer to configure. Must be lower than SEGGER_RTT_MAX_NUM_DOWN_CHANNELS.
sName	Pointer to a 0-terminated string to be displayed as the name of the channel.
pBuffer	Pointer to a buffer used by the channel.
BufferSize	Size of the buffer in Bytes.
Flags	Flags of the channel (blocking or non-blocking).

Table 13.1: SEGGER_RTT_ConfigDownBuffer() parameter list

Return value

```
>= 0   O.K.
< 0    Error.
```

Example

```
//
// Configure down channel 1
//
SEGGER_RTT_ConfigDownChannel(1, "DataIn", &abDataIn[0], sizeof(abDataIn),
                             SEGGER_RTT_MODE_NO_BLOCK_SKIP);
```

Additional information

Once a channel is configured only the flags of the channel should be changed.

13.4.1.2 SEGGER_RTT_ConfigUpBuffer()

Description

Configure or add an up buffer by specifying its name, size and flags.

Prototype

```
int SEGGER_RTT_ConfigUpBuffer (unsigned BufferIndex, const char* sName,
char* pBuffer, int BufferSize, int Flags);
```

Parameters

Parameter	Meaning
BufferIndex	Index of the buffer to configure. Must be lower than SEGGER_RTT_MAX_NUM_UP_CHANNELS.
sName	Pointer to a 0-terminated string to be displayed as the name of the channel.
pBuffer	Pointer to a buffer used by the channel.
BufferSize	Size of the buffer in Bytes.
Flags	Flags of the channel (blocking or non-blocking).

Table 13.2: SEGGER_RTT_ConfigUpBuffer() parameter list

Return value

>= 0 O.K.
< 0 Error.

Example

```
//
// Configure up channel 1 to work in blocking mode
//
SEGGER_RTT_ConfigUpChannel(1, "DataOut", &abDataOut[0], sizeof(abDataOut),
SEGGER_RTT_MODE_BLOCK_IF_FIFO_FULL);
```

Additional information

Once a channel is configured only the flags of the channel should be changed.

13.4.1.3 SEGGER_RTT_GetKey()

Description

Reads one character from SEGGER RTT buffer 0. Host has previously stored data there.

Prototype

```
int SEGGER_RTT_GetKey (void);
```

Return value

< 0 No character available (empty buffer).
>= 0 Character which has been read (0 - 255).

Example

```
int c;
c = SEGGER_RTT_GetKey();
if (c == 'q') {
    exit();
}
```

13.4.1.4 SEGGER_RTT_HasKey()

Description

Checks if at least one character for reading is available in SEGGER RTT buffer. 0

Prototype

```
int SEGGER_RTT_HasKey (void);
```

Return value

- 0 No characters are available to be read.
- 1 At least one character is available in the buffer.

Example

```
if (SEGGER_RTT_HasKey()) {
    int c = SEGGER_RTT_GetKey();
}
```

13.4.1.5 SEGGER_RTT_Init()

Description

Initializes the RTT Control Block.

Prototype

```
void SEGGER_RTT_Init (void);
```

Additional information

Should be used in RAM targets, at start of the application.

13.4.1.6 SEGGER_RTT_printf()

Description

Send a formatted string to the host.

Prototype

```
int SEGGER_RTT_printf (unsigned BufferIndex, const char * sFormat, ...)
```

Parameters

Parameter	Meaning
<code>BufferIndex</code>	Index of the up channel to sent the string to.
<code>sFormat</code>	Pointer to format string, followed by arguments for conversion.

Table 13.3: SEGGER_RTT_printf() parameter list

Return value

- >= 0 Number of bytes which have been sent.
- < 0 Error.

Example

```
SEGGER_RTT_printf(0, "SEGGER RTT Sample. Uptime: %.10dms.", /*OS_Time*/ 890912);
// Formatted output on channel 0: SEGGER RTT Sample. Uptime: 890912ms.
```

Additional information

(1) Conversion specifications have following syntax:

- %[flags][FieldWidth][.Precision]ConversionSpecifier

(2) Supported flags:

- -: Left justify within the field width
- +: Always print sign extension for signed conversions
- 0: Pad with 0 instead of spaces. Ignored when using '-'-flag or precision

(3) Supported conversion specifiers:

- c: Print the argument as one char
- d: Print the argument as a signed integer
- u: Print the argument as an unsigned integer
- x: Print the argument as a hexadecimal integer
- s: Print the string pointed to by the argument
- p: Print the argument as an 8-digit hexadecimal integer. (Argument shall be a pointer to void.)

13.4.1.7 SEGGER_RTT_Read()

Description

Read characters from any RTT down channel which have been previously stored by the host.

Prototype

```
int SEGGER_RTT_Read (unsigned BufferIndex, char* pBuffer, unsigned
BufferIndex);
```

Parameters

Parameter	Meaning
BufferIndex	Index of the down channel to read from.
pBuffer	Pointer to a character buffer to store the read characters.
BufferSize	Number of bytes available in the buffer.

Table 13.4: SEGGER_RTT_Read() parameter list

Return value

>= 0 Number of bytes that have been read.

Example

```
char acIn[4];
int NumBytes = sizeof(acIn);
NumBytes = SEGGER_RTT_Read(0, &acIn[0], NumBytes);
if (NumBytes) {
    AnalyzeInput(acIn);
}
```

13.4.1.8 SEGGER_RTT_SetTerminal()

Description

Set the "virtual" terminal to send following data on channel 0.

Prototype

```
void SEGGER_RTT_SetTerminal(char TerminalId);
```

Parameters

Parameter	Meaning
<code>TerminalId</code>	Id of the virtual terminal (0-9).

Table 13.5: SEGGER_RTT_SetTerminal() parameter list

Example

```
//
// Send a string to terminal 1 which is used as error out.
//
SEGGER_RTT_SetTerminal(1); // Select terminal 1
SEGGER_RTT_WriteString(0, "ERROR: Buffer overflow");
SEGGER_RTT_SetTerminal(0); // Reset to standard terminal
```

Additional information

All following data which is sent via channel 0 will be printed on the set terminal until the next change.

13.4.1.9 SEGGER_RTT_TerminalOut()

Description

Send one string to a specific "virtual" terminal.

Prototype

```
int SEGGER_RTT_TerminalOut (char TerminalID, const char* s);
```

Parameters

Parameter	Meaning
<code>TerminalId</code>	Id of the virtual terminal (0-9).
<code>s</code>	Pointer to 0-terminated string to be sent.

Table 13.6: SEGGER_RTT_TerminalOut() parameter list

Return value

≥ 0 Number of bytes sent to the terminal.

Example

```
//
// Sent a string to terminal 1 without changing the standard terminal.
//
SEGGER_RTT_TerminalOut(1, "ERROR: Buffer overflow.");
```

Additional information

SEGGER_RTT_TerminalOut does not affect following data which is sent via channel 0.

13.4.1.10 SEGGER_RTT_Write()

Description

Send data to the host on an RTT channel.

Prototype

```
int SEGGER_RTT_Write (unsigned BufferIndex, const char* pBuffer, unsigned NumBytes);
```

Parameters

Parameter	Meaning
<code>BufferIndex</code>	Index of the up channel to send data to.
<code>pBuffer</code>	Pointer to data to be sent.
<code>NumBytes</code>	Number of bytes to send.

Table 13.7: SEGGER_RTT_Write() parameter list

Return value

≥ 0 Number of bytes which have been sent.

Additional information

With `SEGGER_RTT_Write()` all kinds of data, not only printable one can be sent.

13.4.1.11 SEGGER_RTT_WaitKey()

Description

Waits until at least one character is available in SEGGER RTT buffer 0. Once a character is available, it is read and returned.

Prototype

```
int SEGGER_RTT_WaitKey (void);
```

Return value

≥ 0 Character which has been read (0 - 255).

Example

```
int c = 0;
do {
    c = SEGGER_RTT_WaitKey();
} while (c != 'c');
```

13.4.1.12 SEGGER_RTT_WriteString()

Description

Write a 0-terminated string to an up channel via RTT.

Prototype

```
int SEGGER_RTT_WriteString (unsigned BufferIndex, const char* s);
```

Parameters

Parameter	Meaning
<code>BufferIndex</code>	Index of the up channel to send string to.
<code>s</code>	Pointer to 0-terminated string to be sent.

Table 13.8: SEGGER_RTT_WriteString() parameter list

Return value

≥ 0 Number of bytes which have been sent.

Example

```
SEGGER_RTT_WriteString(0, "Hello World from your target.\n");
```

13.4.2 Configuration defines

13.4.2.1 RTT configuration

SEGGER_RTT_MAX_NUM_DOWN_BUFFERS

Maximum number of down (to target) channels.

SEGGER_RTT_MAX_NUM_UP_BUFFERS

Maximum number of up (to host) channels.

BUFFER_SIZE_DOWN

Size of the buffer for default down channel 0.

BUFFER_SIZE_UP

Size of the buffer for default up channel 0.

SEGGER_RTT_PRINT_BUFFER_SIZE

Size of the buffer for SEGGER_RTT_printf to bulk-send chars.

SEGGER_RTT_LOCK()

Locking routine to prevent interrupts and task switches from within an RTT operation.

SEGGER_RTT_UNLOCK()

Unlocking routine to allow interrupts and task switches after an RTT operation.

SEGGER_RTT_IN_RAM

Indicate the whole application is in RAM to prevent falsely identifying the RTT Control Block in the init segment by defining as 1.

13.4.2.2 Channel buffer configuration

SEGGER_RTT_MODE_BLOCK_IF_FIFO_FULL

SEGGER_RTT_NO_BLOCK_SKIP

SEGGER_RTT_NO_BLOCK_TRIM

13.4.2.3 Color control sequences

RTT_CTRL_RESET

Reset the text color and background color.

RTT_CTRL_TEXT_*

Set the text color to one of the following colors.

- BLACK
- RED
- GREEN
- YELLOW
- BLUE
- MAGENTA
- CYAN
- WHITE (light grey)
- BRIGHT_BLACK (dark grey)
- BRIGHT_RED

- BRIGHT_GREEN
- BRIGHT_YELLOW
- BRIGHT_BLUE
- BRIGHT_MAGENTA
- BRIGHT_CYAN
- BRIGHT_WHITE

RTT_CTRL_BG_*

Set the background color to one of the following colors.

- BLACK
- RED
- GREEN
- YELLOW
- BLUE
- MAGENTA
- CYAN
- WHITE (light grey)
- BRIGHT_BLACK (dark grey)
- BRIGHT_RED
- BRIGHT_GREEN
- BRIGHT_YELLOW
- BRIGHT_BLUE
- BRIGHT_MAGENTA
- BRIGHT_CYAN
- BRIGHT_WHITE

13.5 ARM Cortex - Background memory access

On ARM Cortex targets, background memory access necessary for RTT is performed via a so-called AHB-AP which is similar to a DMA but exclusively accessible by the debug probe. While on Cortex-M targets there is always an AHB-AP present, on Cortex-A and Cortex-R targets this is an optional component. CortexA/R targets may implement multiple APs (some even not an AHB-AP at all), so in order to use RTT on Cortex-A/R targets, the index of the AP which is the AHB-AP that shall be used for RTT background memory access, needs to be manually specified. This is done via the following J-Link Command string: *CORESIGHT_SetIndexAHBAPToUse* on page 235. For more information about how to use J-Link command strings in various environments, please refer to *Using command strings* on page 251.

13.6 Example code

```

/*****
*          SEGGER MICROCONTROLLER GmbH & Co KG          *
*          Solutions for real time microcontroller applications *
*****
*
*          (c) 2014 SEGGER Microcontroller GmbH & Co KG    *
*
*          www.segger.com      Support: support@segger.com  *
*****

-----
File      : RTT.c
Purpose  : Simple implementation for output via RTT.
           It can be used with any IDE.
-----
END-OF-HEADER -----
*/

#include "SEGGER_RTT.h"

static void _Delay(int period) {
    int i = 100000*period;
    do { ; } while (i--);
}

int main(void) {
    int Cnt = 0;

    SEGGER_RTT_WriteString(0, "Hello World from SEGGER!\n");
    do {
        SEGGER_RTT_printf("%sCounter: %s%d\n",
            RTT_CTRL_TEXT_BRIGHT_WHITE,
            RTT_CTRL_TEXT_BRIGHT_GREEN,
            Cnt);
        if (Cnt > 100) {
            SEGGER_RTT_TerminalOut(1, RTT_CTRL_TEXT_BRIGHT_RED"Counter overflow!");
            Cnt = 0;
        }
        _Delay(100);
        Cnt++;
    } while (1);
    return 0;
}

/***** End of file *****/

```

13.7 FAQ

- Q: How does J-Link find the RTT buffer?
 A: There are two ways: If the debugger (IDE) knows the address of the SEGGER RTT Control Block, it can pass it to J-Link. This is for example done by J-Link Debugger. If another application that is not SEGGER RTT aware is used, then J-Link searches for the ID in the known target RAM during execution of the application in the background. This process normally takes just fractions of a second and does not delay program execution.
- Q: I am debugging a RAM-only application. J-Link finds an RTT buffer, but I get no output. What can I do?
 A: In case the init section of an application is stored in RAM, J-Link might falsely identify the block in the init section instead of the actual one in the data section. To prevent this, set the define `SEGGER_RTT_IN_RAM` to 1. Now J-Link will find the correct RTT buffer, but only after calling the first `SEGGER_RTT` function in the application. A call to `SEGGER_RTT_Init()` at the beginning of the application is recommended.
- Q: Can this also be used on targets that do not have the SWO pin?
 A: Yes, the debug interface is used. This can be JTAG or SWD (2pins only!) on most Cortex-M devices, or even the FINE interface on some Renesas devices, just like the Infineon SPD interface (single pin!).
- Q: Can this also be used on Cortex-M0 and M0+?
 A: Yes.
- Q: Some terminal output (printf) Solutions "crash" program execution when executed outside of the debug environment, because they use a Software breakpoint that triggers a hardfault without debugger or halt because SWO is not initialized. That makes it impossible to run a Debug-build in stand-alone mode. What about SEGGER-RTT?
 A: SEGGER-RTT uses non-blocking mode per default, which means it does not halt program execution if no debugger is present and J-Link is not even connected. The application program will continue to work.
- Q: I do not see any output, although the use of RTT in my application is correct. What can I do?
 A: In some cases J-Link cannot locate the RTT buffer in the known RAM region. In this case the possible region or the exact address can be set manually via a J-Link exec command:
- Set ranges to be searched for RTT buffer: `SetRTTSearchRanges <RangeStart [Hex]> <RangeSize >[, <Range1Start [Hex]> <Range1Size>, ...]` (e.g. "`SetRTTSearchRanges 0x10000000 0x1000, 0x20000000 0x1000`")
 - Set address of the RTT buffer: `SetRTTAddr <RTTBufferAddress [Hex]>` (e.g. "`SetRTTAddr 0x20000000`")
 - Set address of the RTT buffer via J-Link Control Panel -> RTTerminal
- Note:** J-Link exec commands can be executed in most applications, for example in J-Link Commander via "`exec <Command>`", in J-Link GDB Server via "`monitor exec <Command>`" or in IAR EW via "`__jlinkExecCommand("<Command>");`" from a macro file.

Chapter 14

Device specifics

This chapter describes for which devices some special handling is necessary to use them with J-Link.

14.1 Analog Devices

J-Link has been tested with the following MCUs from Analog Devices:

- AD7160
- ADuC7020x62
- ADuC7021x32
- ADuC7021x62
- ADuC7022x32
- ADuC7022x62
- ADuC7024x62
- ADuC7025x32
- ADuC7025x62
- ADuC7026x62
- ADuC7027x62
- ADuC7028x62
- ADuC7030
- ADuC7031
- ADuC7032
- ADuC7033
- ADuC7034
- ADuC7036
- ADuC7038
- ADuC7039
- ADuC7060
- ADuC7061
- ADuC7062
- ADuC7128
- ADuC7129
- ADuC7229x126
- ADuCRF02
- ADuCRF101

14.1.1 ADuC7xxx

14.1.1.1 Software reset

A special reset strategy has been implemented for Analog Devices ADuC7xxx MCUs. This special reset strategy is a software reset. "Software reset" means basically RESET pin is used to perform the reset, the reset is initiated by writing special function registers via software.

The software reset for Analog Devices ADuC7xxxx executes the following sequence:

- The CPU is halted
- A software reset sequence is downloaded to RAM.
- A breakpoint at address 0 is set
- The software reset sequence is executed.

It is recommended to use this reset strategy. This sequence performs a reset of CPU and peripherals and halts the CPU before executing instructions of the user program. It is the recommended reset sequence for Analog Devices ADuC7xxx MCUs and works with these devices only.

This information is applicable to the following devices:

- Analog ADuC7020x62
- Analog ADuC7021x32
- Analog ADuC7021x62
- Analog ADuC7022x32
- Analog ADuC7022x62
- Analog ADuC7024x62
- Analog ADuC7025x32
- Analog ADuC7025x62

- Analog ADuC7026x62
- Analog ADuC7027x62
- Analog ADuC7030
- Analog ADuC7031
- Analog ADuC7032
- Analog ADuC7033
- Analog ADuC7128
- Analog ADuC7129
- Analog ADuC7229x126

14.2 ATMEL

J-Link has been tested with the following ATMEL devices:

- AT91SAM3A2C
- AT91SAM3A4C
- AT91SAM3A8C
- AT91SAM3N1A
- AT91SAM3N1B
- AT91SAM3N1C
- AT91SAM3N2A
- AT91SAM3N2B
- AT91SAM3N2C
- AT91SAM3N4A
- AT91SAM3N4B
- AT91SAM3N4C
- AT91SAM3S1A
- AT91SAM3S1B
- AT91SAM3S1C
- AT91SAM3S2A
- AT91SAM3S2B
- AT91SAM3S2C
- AT91SAM3S4A
- AT91SAM3S4B
- AT91SAM3S4C
- AT91SAM3U1C
- AT91SAM3U2C
- AT91SAM3U4C
- AT91SAM3U1E
- AT91SAM3U2E
- AT91SAM3U4E
- AT91SAM3X2C
- AT91SAM3X2E
- AT91SAM3X2G
- AT91SAM3X2H
- AT91SAM3X4C
- AT91SAM3X4E
- AT91SAM3X4G
- AT91SAM3X4H
- AT91SAM3X8C
- AT91SAM3X8E
- AT91SAM3X8G
- AT91SAM3X8H
- AT91SAM7A3
- AT91SAM7L64
- AT91SAM7L128
- AT91SAM7S16
- AT91SAM7S161
- AT91SAM7S32
- AT91SAM7S321
- AT91SAM7S64
- AT91SAM7S128
- AT91SAM7S256
- AT91SAM7S512
- AT91SAM7SE32
- AT91SAM7SE256
- AT91SAM7SE512
- AT91SAM7X128
- AT91SAM7X256
- AT91SAM7X512
- AT91SAM7XC128
- AT91SAM7XC256

- AT91SAM7XC512
- AT91SAM9XE128
- AT91SAM9XE256

14.2.1 AT91SAM7

14.2.1.1 Reset strategy

The reset pin of the device is per default disabled. This means that the reset strategies which rely on the reset pin (low pulse on reset) do not work per default. For this reason a special reset strategy has been made available.

It is recommended to use this reset strategy. This special reset strategy resets the peripherals by writing to the RSTC_CR register. Resetting the peripherals puts all peripherals in the defined reset state. This includes memory mapping register, which means that after reset flash is mapped to address 0. It is also possible to achieve the same effect by writing 0x4 to the RSTC_CR register located at address 0xfffffd00.

This information is applicable to the following devices:

- AT91SAM7S (all devices)
- AT91SAM7SE (all devices)
- AT91SAM7X (all devices)
- AT91SAM7XC (all devices)
- AT91SAM7A (all devices)

14.2.1.2 Memory mapping

Either flash or RAM can be mapped to address 0. After reset flash is mapped to address 0. In order to `majlink_supported_devices.html` RAM to address 0, a 1 can be written to the RSTC_CR register. Unfortunately, this remap register is a toggle register, which switches between RAM and flash every time bit zero is written.

In order to achieve a defined mapping, there are two options:

1. Use the software reset described above.
2. Test if RAM is located at 0 using multiple read/write operations and testing the results.

Clearly 1. is the easiest solution and is recommended.

This information is applicable to the following devices:

- AT91SAM7S (all devices)
- AT91SAM7SE (all devices)
- AT91SAM7X (all devices)
- AT91SAM7XC (all devices)
- AT91SAM7A (all devices)

14.2.1.3 Recommended init sequence

In order to work with an ATMEL AT91SAM7 device, it has to be initialized. The following paragraph describes the steps of an init sequence. An example for different software tools, such as J-Link GDB Server, IAR Workbench and RDI, is given.

- Set JTAG speed to 30kHz.
- Reset target.
- Perform peripheral reset.
- Disable watchdog.
- Initialize PLL.
- Use full JTAG speed.

Samples

GDB Sample

```
# connect to the J-Link gdb server
target remote localhost:2331
monitor flash device = AT91SAM7S256
monitor flash download = 1
monitor flash breakpoints = 1
# Set JTAG speed to 30 kHz
monitor endian little
monitor speed 30
# Reset the target
monitor reset 8
monitor sleep 10
# Perform peripheral reset
monitor long 0xFFFFFD00 = 0xA5000004
monitor sleep 10
# Disable watchdog
monitor long 0xFFFFD44 = 0x00008000
monitor sleep 10
# Initialize PLL
monitor long 0xFFFFC20 = 0x00000601
monitor sleep 10
monitor long 0xFFFFC2C = 0x00480a0e
monitor sleep 10
monitor long 0xFFFFC30 = 0x00000007
monitor sleep 10
monitor long 0xFFFFF60 = 0x00480100
monitor sleep 100
monitor speed 12000
break main
load
continue
```

IAR Sample

```
/*
 *
 *      _Init()
 */
_Init() {
    __emulatorSpeed(30000);                // Set JTAG speed to 30 kHz
    __writeMemory32(0xA5000004, 0xFFFFFD00, "Memory"); // Perform peripheral reset
    __sleep(20000);
    __writeMemory32(0x00008000, 0xFFFFD44, "Memory"); // Disable Watchdog
    __sleep(20000);
    __writeMemory32(0x00000601, 0xFFFFC20, "Memory"); // PLL
    __sleep(20000);
    __writeMemory32(0x10191c05, 0xFFFFC2C, "Memory"); // PLL
    __sleep(20000);
    __writeMemory32(0x00000007, 0xFFFFC30, "Memory"); // PLL
    __sleep(20000);
    __writeMemory32(0x002f0100, 0xFFFFF60, "Memory"); // Set 1 wait state for
    __sleep(20000); // flash (2 cycles)
    __emulatorSpeed(12000000); // Use full JTAG speed
}

/*
 *
 *      execUserReset()
 */
execUserReset() {
    __message "execUserReset()";
    _Init();
}

/*
 *
 *      execUserPreload()
 */
execUserPreload() {
    __message "execUserPreload()";
    _Init();
}
```

RDI Sample

```

SetJTAGSpeed(30); // Set JTAG speed to 30 kHz
Reset(0, 0);
Write32(0xFFFFD00, 0xA5000004); // Perform peripheral reset
Write32(0xFFFFD44, 0x00008000); // Disable watchdog
Write32(0xFFFFC20, 0x00000601); // Set PLL
Delay(200);
Write32(0xFFFFC2C, 0x00191C05); // Set PLL and divider
Delay(200);
Write32(0xFFFFC30, 0x00000007); // Select master clock and processor clock
Write32(0xFFFFF60, 0x00320300); // Set flash wait states
SetJTAGSpeed(12000);

```

14.2.2 AT91SAM9

14.2.2.1 JTAG settings

We recommend using adaptive clocking.

This information is applicable to the following devices:

- AT91RM9200
- AT91SAM9260
- AT91SAM9261
- AT91SAM9262
- AT91SAM9263

14.3 DSPGroup

J-Link has been tested with the following DSPGroup devices:

- DA56KLF

Currently, there are no specifics for these devices.

14.4 Ember

For more information, please refer to *Silicon Labs* on page 407.

14.5 Energy Micro

For more information, please refer to *Silicon Labs* on page 407.

14.6 Freescale

J-Link has been tested with the following Freescale devices:

- MAC7101
- MAC7106
- MAC7111
- MAC7112
- MAC7116
- MAC7121
- MAC7122
- MAC7126
- MAC7131
- MAC7136
- MAC7141
- MAC7142
- MK10DN512
- MK10DX128
- MK10DX256
- MK20DN512
- MK20DX128
- MK20DX256
- MK30DN512
- MK30DX128
- MK30DX256
- MK40N512
- MK40X128
- MK40X256
- MK50DN512
- MK50DX256
- MK50DN512
- MK50DX256
- MK51DX256
- MK51DN512
- MK51DX256
- MK51DN512
- MK51DN256
- MK51DN512
- MK52DN512
- MK53DN512
- MK53DX256
- MK60N256
- MK60N512
- MK60X256

14.6.1 Kinetis family

14.6.1.1 Unlocking

If your device has been locked by setting the MCU security status to "secure", and mass erase via debug interface is not disabled, J-Link is able to unlock your Kinetis K40/K60 device. The device can be unlocked by using the "unlock" command in J-Link Commander.

For more information regarding the MCU security status of the Kinetis devices, please refer to the user manual of your device.

14.6.1.2 Tracing

The first silicon of the Kinetis devices did not match the data setup and hold times which are necessary for ETM-Trace. On these devices, a low drive strength should be configured for the trace clock pin in order to match the timing requirements.

On later silicons, this has been corrected. This bug applies to all devices with mask 0M33Z from the 100MHz series.

The J-Link software and documentation package comes with a sample project for the Kinetis K40 and K60 devices which is pre-configured for the TWR-40 and TWR-60 eval boards and ETM / ETB Trace. This sample project can be found at `\Samples\JLink\Projects`.

14.6.1.3 Data flash support

Some devices of the Kinetis family have an additional area called FlexNVM, which can be configured as data flash. The size of the FlexNVM to be used as data flash is configurable and needs to be configured first, before this area can be used as data flash.

The sample below shows how to configure the FlexNVM area to be used as data flash out of the target application.

For J-Flash there are also projects that are preconfigured to setup the data flash size of a Kinetis device. The projects can be found at `$JLINK_INST_DIR\Samples\JFlash\ProjectFiles`. One of these sample projects is the `MK40DX256xxx10_ConfigureDataFlash.jflash`.

For more information about how configuration of the data flash works, please refer to the appropriate user manual of the device.

Configure FlexNVM area as data flash

The following sample configures the data flash size of Kinetis device. It is created for a MK40DX256xxx10 device. The sequence is almost the same for all Kinetis devices only the lines which configure size of the data flash may be modified. In this sample the data flash is set to max size. EEPROM size is set to 0 bytes.

```
#define FSTAT    (*(volatile unsigned char*)(0x40020000 + 0x00))
#define FCCOB0   (*(volatile unsigned char*)(0x40020000 + 0x07))
#define FCCOB1   (*(volatile unsigned char*)(0x40020000 + 0x06))
#define FCCOB2   (*(volatile unsigned char*)(0x40020000 + 0x05))
#define FCCOB3   (*(volatile unsigned char*)(0x40020000 + 0x04))
#define FCCOB4   (*(volatile unsigned char*)(0x40020000 + 0x0B))
#define FCCOB5   (*(volatile unsigned char*)(0x40020000 + 0x0A))
#define FCCOB6   (*(volatile unsigned char*)(0x40020000 + 0x09))
#define FCCOB7   (*(volatile unsigned char*)(0x40020000 + 0x08))
#define FCCOB8   (*(volatile unsigned char*)(0x40020000 + 0x0F))

void ConfigureDataFlash(void);

*****
*
*       ConfigureDataFlash
*
* Notes
* Needs to be located in RAM since it performs flash operations
* which make instruction fetching from flash temporarily not possible.
*/
void ConfigureDataFlash(void) {
    unsigned char v;

    //
    // Read out current configuration first
    //
    FSTAT = 0x70;           // Clear error flags in status register
    FCCOB0 = 0x03;         // Read resource
    FCCOB1 = 0x80;         // Read from data flash IFR area with offset 0xFC (0x8000FC)
    FCCOB2 = 0x00;
    FCCOB3 = 0xFC;
    FCCOB8 = 0x00;         // Select IFR area to be read
    FSTAT = 0x80;         // Start command execution
    while((FSTAT & 0x80) == 0); // Wait until flash controller has finished
    //
}
```

```
// Check current data flash & EEPROM config
//
v = FCCOB6;                // IFR offset 0xFD
if (v != 0xFF) {          // EEPROM data set size already configured?
    return;
}
v = FCCOB7;                // IFR offset 0xFC
if (v != 0xFF) {          // FlexNVM partition code already configured?
    return;
}
//
// Configure EEPROM size and data flash size
// via the program partition command
//
FCCOB0 = 0x80;            // Program partition
FCCOB4 = 0x3F;            // EEPROM data size code: 0 KB EEPROM
FCCOB5 = 0x00;            // FlexNVM partition code: 256 KB data flash
FSTAT = 0x80;            // Start command execution
while((FSTAT & 0x80) == 0); // Wait until flash controller has finished
}
```

14.7 Fujitsu

J-Link has been tested with the following Fujitsu devices:

- MB9AF102N
- MB9AF102R
- MB9AF104N
- MB9AF104R
- MB9BF104N
- MB9BF104R
- MB9BF105N
- MB9BF105R
- MB9BF106N
- MB9BF106R
- MB9BF304N
- MB9BF304R
- MB9BF305N
- MB9BF305R
- MB9BF306N
- MB9BF306R
- MB9BF404N
- MB9BF404R
- MB9BF405N
- MB9BF405R
- MB9BF406N
- MB9BF406R
- MB9BF504N
- MB9BF504R
- MB9BF505N
- MB9BF505R
- MB9BF506N
- MB9BF506R

Currently, there are no specifics for these devices.

14.8 Itron

J-Link has been tested with the following Itron devices:

- TRIFECTA

Currently, there are no specifics for these devices.

14.9 Infineon

J-Link has been tested with the following Infineon devices:

- UMF1110
- UMF1120
- UMF5110
- UMF5120
- XMC1100-T016F00xx
- XMC1100-T038F00xx
- XMC1100-T038F0xxx
- XMC1201-T028F0xxx
- XMC1201-T038F0xxx
- XMC1202-T016X00xx
- XMC1202-T028X00xx
- XMC1202-T038X00xx
- XMC1203-T016X0xxx
- XMC1301-T016F00xx
- XMC1302-T038X0xxx
- XMC4100-128
- XMC4104-128
- XMC4104-64
- XMC4200-256
- XMC4400-256
- XMC4400-512
- XMC4402-256
- XMC4500-1024
- XMC4500-768
- XMC4502
- XMC4504

Currently, there are no specifics for these devices.

14.10 Luminary Micro

J-Link has been tested with the following Luminary Micro devices:

- LM3S101
- LM3S102
- LM3S301
- LM3S310
- LM3S315
- LM3S316
- LM3S317
- LM3S328
- LM3S601
- LM3S610
- LM3S611
- LM3S612
- LM3S613
- LM3S615
- LM3S617
- LM3S618
- LM3S628
- LM3S801
- LM3S811
- LM3S812
- LM3S815
- LM3S817
- LM3S818
- LM3S828
- LM3S2110
- LM3S2139
- LM3S2410
- LM3S2412
- LM3S2432
- LM3S2533
- LM3S2620
- LM3S2637
- LM3S2651
- LM3S2730
- LM3S2739
- LM3S2939
- LM3S2948
- LM3S2950
- LM3S2965
- LM3S6100
- LM3S6110
- LM3S6420
- LM3S6422
- LM3S6432
- LM3S6610
- LM3S6633
- LM3S6637
- LM3S6730
- LM3S6938
- LM3S6952
- LM3S6965

14.10.1 Unlocking LM3Sxxx devices

If your device has been "locked" accidentally (e.g. by bad application code in flash which mis-configures the PLL) and J-Link can not identify it anymore, there is a special unlock sequence which erases the flash memory of the device, even if it cannot be identified. This unlock sequence can be sent to the target, by using the "unlock" command in J-Link Commander.

14.11 NXP

J-Link has been tested with the following NXP devices:

- LPC1111
- LPC1113
- LPC1311
- LPC1313
- LPC1342
- LPC1343
- LPC1751
- LPC1751
- LPC1752
- LPC1754
- LPC1756
- LPC1758
- LPC1764
- LPC1765
- LPC1766
- LPC1768
- LPC2101
- LPC2102
- LPC2103
- LPC2104
- LPC2105
- LPC2106
- LPC2109
- LPC2114
- LPC2119
- LPC2124
- LPC2129
- LPC2131
- LPC2132
- LPC2134
- LPC2136
- LPC2138
- LPC2141
- LPC2142
- LPC2144
- LPC2146
- LPC2148
- LPC2194
- LPC2212
- LPC2214
- LPC2292
- LPC2294
- LPC2364
- LPC2366
- LPC2368
- LPC2378
- LPC2468
- LPC2478
- LPC2880
- LPC2888
- LPC2917
- LPC2919
- LPC2927
- LPC2929
- PCF87750
- SJA2010
- SJA2510

14.11.1 LPC ARM7-based devices

14.11.1.1 Fast GPIO bug

The values of the fast GPIO registers cannot be read directly via JTAG from a debugger. The direct access to the registers corrupts the returned values. This means that the values in the fast GPIO registers normally cannot be checked or changed by a debugger.

Solution / Workaround

J-Link supports command strings which can be used to read a memory area indirectly. Indirect reading means that a small code snippet will be written into RAM of the target device, which reads and transfers the data of the specified memory area to the debugger. Indirect reading solves the fast GPIO problem, because only direct register access corrupts the register contents.

Define a 256 byte aligned area in RAM of the LPC target device with the J-Link command `map ram` and define afterwards the memory area which should be read indirectly with the command `map indirectread` to use the indirectly reading feature of J-Link. Note that the data in the defined RAM area is saved and will be restored after using the RAM area.

This information is applicable to the following devices:

- LPC2101
- LPC2102
- LPC2103
- LPC213x/01
- LPC214x (all devices)
- LPC23xx (all devices)
- LPC24xx (all devices)

Example

J-Link command line options can be used for example with the C-SPY debugger of the IAR Embedded Workbench. Open the **Project options** dialog and select **Debugger**. Select **Use command line options** in the **Extra Options** tab and enter in the textfield `--jlink_exec_command "map ram 0x40000000-0x40003fff; map indirectread 0x3fffc000-0x3fffcfff; map exclude 0x3fffd000-0x3ffffff;"` as shown in the screenshot below.

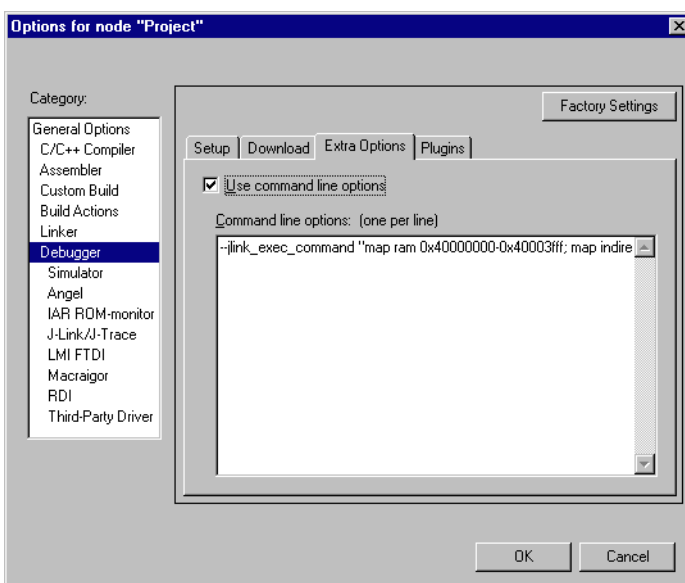

With these additional commands the values of the fast GPIO registers in the C-SPY debugger are correct and can be used for debugging. For more information about J-Link command line options refer to subchapter *Command strings* on page 233.

14.11.1.2RDI

J-Link comes with a device-based RDI license for NXP LPC21xx-LPC24xx devices. This means the J-Link RDI software can be used with LPC21xx-LPC24xx devices free of charge. For more information about device-based licenses, please refer to *License types* on page 69.

14.11.2 Reset (Cortex-M3 based devices)

For Cortex-M3 based NXP LPC devices the reset itself does not differ from the one for other Cortex-M3 based devices: After the device has been reset, the core is halted before any instruction is performed. For the Cortex-M3 based LPC devices this means the CPU is halted before the bootloader which is mapped at address 0 after reset.

The user should write the memmap register after reset, to ensure that user flash is mapped at address 0. Moreover, the user have to correct the Stack pointer (R13) and the PC (R15) manually, after reset in order to debug the application.

14.11.3 LPC288x flash programming

In order to use the LPC288x devices in combination with the J-Link flash download feature, the application you are trying to debug, should be linked to the original flash @ addr 0x10400000. Otherwise it is user's responsibility to ensure that flash is re-mapped to 0x0 in order to debug the application from addr 0x0.

14.11.4 LPC43xx:

All devices of the LPC43xx are dual core devices (One Cortex-M4 core and one Cortex-M0 core). For these devices, a J-Link script file is needed (exact file depends on if the Cortex-M4 or the Cortex-M0 shall be debugged) in order to guarantee proper functionality.

Script file can be found at `$JLINK_INST_DIR$\Samples\JLink\Scripts`

For more information about how to use J-Link script files, please refer to *Executing J-Link script files* on page 230.

14.12 OKI

J-Link has been tested with the following OKI devices:

- ML67Q4002
- ML67Q4003
- ML67Q4050
- ML67Q4051
- ML67Q4060
- ML67Q4061

Currently, there are no specifics for these devices.

14.13 Renesas

J-Link has been tested with the following Renesas devices:

- R5F56104
- R5F56106
- R5F56107
- R5F56108
- R5F56216
- R5F56217
- R5F56218
- R5F562N7
- R5F562N8
- R5F562T6
- R5F562T7
- R5F562TA

Currently, there are no specifics for these devices.

14.14 Samsung

J-Link has been tested with the following Samsung devices:

- S3FN60D

14.14.1 S3FN60D

On the S3FN60D the watchdog may be running after reset (depends on the content of the smart option bytes at addr. 0xC0). The watchdog keeps counting even if the CPU is in debug mode (e.g. halted). So, please do not use the watchdog when debugging to avoid unexpected behavior of the target application. A special reset strategy has been implemented for this device which disables the watchdog right after a reset has been performed. We recommend to use this reset strategy when debugging a Samsung S3FN60D device.

14.15 Silicon Labs

J-Link has been tested with the following Silicon Labs devices:

- EFM32G200F16
- EFM32G200F32
- EFM32G200F64
- EFM32G210F128
- EFM32G230F32
- EFM32G230F64
- EFM32G230F128
- EFM32G280F32
- EFM32G280F64
- EFM32G280F128
- EFM32G290F32
- EFM32G290F64
- EFM32G290F128
- EFM32G840F32
- EFM32G840F64
- EFM32G840F128
- EFM32G880F32
- EFM32G880F64
- EFM32G880F128
- EFM32G890F32
- EFM32G890F64
- EFM32G890F128
- EFM32TG108F4
- EFM32TG108F8
- EFM32TG108F16
- EFM32TG108F32
- EFM32TG110F4
- EFM32TG110F8
- EFM32TG110F16
- EFM32TG110F32
- EFM32TG210F8
- EFM32TG210F16
- EFM32TG210F32
- EFM32TG230F8
- EFM32TG230F16
- EFM32TG230F32
- EFM32TG840F8
- EFM32TG840F16
- EFM32TG840F32
- EM351
- EM357

14.15.1 EFM32 series devices

14.15.1.1 SWO

Usually, the SWO output frequency of a device is directly dependent on the CPU speed. The SWO speed is calculated as: $\langle \text{CPUFreq} \rangle / n$. On the EFM32 series this is not the case:

The SWO related units (ITM, TPIU, ...) are chip-internally wired to a fixed 14 MHz clock (AUXHFRCO).

This will cause the auto-detection of J-Link to not work by default for these devices, if the CPU is running at a different speed than AUXHFRCO. All utilities that use SWO speed auto-detection, like the J-Link SWOViewer, need to be told that the CPU is running at 14 MHz, to make SWO speed auto-detection work, no matter what speed the CPU is really running at.

14.16 ST Microelectronics

J-Link has been tested with the following ST Microelectronics devices:

- STR710FZ1
- STR710FZ2
- STR711FR0
- STR711FR1
- STR711FR2
- STR712FR0
- STR712FR1
- STR712FR2
- STR715FR0
- STR730FZ1
- STR730FZ2
- STR731FV0
- STR731FV1
- STR731FV2
- STR735FZ1
- STR735FZ2
- STR736FV0
- STR736FV1
- STR736FV2
- STR750FV0
- STR750FV1
- STR750FV2
- STR751FR0
- STR751FR1
- STR751FR2
- STR752FR0
- STR752FR1
- STR752FR2
- STR755FR0
- STR755FR1
- STR755FR2
- STR755FV0
- STR755FV1
- STR755FV2
- STR911FM32
- STR911FM44
- STR911FW32
- STR911FW44
- STR912FM32
- STR912FM44
- STR912FW32
- STR912FW44
- STM32F101C6
- STM32F101C8
- STM32F101R6
- STM32F101R8
- STM32F101RB
- STM32F101V8
- STM32F101VB
- STM32F103C6
- STM32F103C8
- STM32F103R6
- STM32F103R8
- STM32F103RB
- STM32F103V8
- STM32F103VB

14.16.1 STR91x

14.16.1.1 JTAG settings

These devices are ARM966E-S based. We recommend to use adaptive clocking for these devices.

14.16.1.2 Unlocking

The devices have 3 TAP controllers built-in. When starting `J-Link.exe`, it reports 3 JTAG devices. A special tool, J-Link STR9 Commander (`JLinkSTR91x.exe`) is available to directly access the flash controller of the device. This tool can be used to erase the flash of the controller even if a program is in flash which causes the ARM core to stall. For more information about the J-Link STR9 Commander, please refer to *J-Link STR91x Commander (Command line tool)* on page 161.

When starting the STR91x commander, a command sequence will be performed which brings MCU into Turbo Mode.

"While enabling the Turbo Mode, a dedicated test mode signal is set and controls the GPIOs in output. The IOs are maintained in this state until a next JTAG instruction is sent." (ST Microelectronics)

Enabling Turbo Mode is necessary to guarantee proper function of all commands in the STR91x Commander.

14.16.1.3 Switching the boot bank

The bootbank of the STR91x devices can be switched by using the J-Link STR9 Commander which is part of the J-Link software and documentation package. For more information about the J-Link STR9 Commander, please refer to *J-Link STR91x Commander (Command line tool)* on page 161.

14.16.2 STM32F10xxx

These devices are Cortex-M3 based.
All devices of this family are supported by J-Link.

14.16.2.1 ETM init

The following sequence can be used to prepare STM32F10xxx devices for 4-bit ETM tracing:

```
int v;
//
// DBGMCU_CR, enable trace I/O and configure pins for 4-bit trace.
//
v = *((volatile int *) (0xE0042004));
v &= ~(7 << 5); // Preserve all bits except the trace pin configuration
v |= (7 << 5); // Enable trace I/O and configure pins for 4-bit trace
*((volatile int *) (0xE0042004)) = v;
```

14.16.2.2 Option byte programming

J-Flash supports programming of the option bytes for STM32 devices. In order to program the option bytes simply choose the appropriate Device, which allows option byte programming, in the CPU settings tab (e.g. **STM32F103ZE (allow opt. bytes)**). J-Flash will allow programming a virtual 16-byte sector at address

0x06000000 which represents the 8 option bytes and their complements. You do not have to care about the option bytes' complements since they are computed automatically. The following table describes the structure of the option bytes sector:

Address	[31:24]	[23:16]	[15:8]	[7:0]
0x06000000	complement	Option byte 1	complement	Option byte 0
0x06000004	complement	Option byte 3	complement	Option byte 2
0x06000008	complement	Option byte 5	complement	Option byte 4
0x0600000C	complement	Option byte 7	complement	Option byte 6

Table 14.1: Option bytes sector description

Note: Writing a value of 0xFF inside option byte 0 will read-protect the STM32. In order to keep the device unprotected you have to write the key value 0xA5 into option byte 0.

Note: The address 0x06000000 is a virtual address only. The option bytes are originally located at address 0x1FFF800. The remap from 0x06000000 to 0x1FFF800 is done automatically by J-Flash.

Example

To program the option bytes 2 and 3 with the values 0xAA and 0xBB, but leave the device unprotected your option byte sector (at addr 0x06000000) should look like as follows:

Address	[31:24]	[23:16]	[15:8]	[7:0]
0x06000000	0x00	0xFF	0x5A	0xA5
0x06000004	0x44	0xBB	0x55	0xAA
0x06000008	0x00	0xFF	0x00	0xFF
0x0600000C	0x00	0xFF	0x00	0xFF

Table 14.2: Option bytes programming example

For a detailed description of each option byte, please refer to *ST programming manual PM0042, section "Option byte description"*.

14.16.2.3 Securing/unsecuring the device

The user area internal flash of the STM32 devices can be protected (secured) against read by untrusted code. The J-Flash software allows securing a STM32F10x device. For more information about J-Flash, please refer to *UM08003, J-Flash User Guide*. In order to unsecure a read-protected STM32F10x device, SEGGER offers two software components:

- J-Flash
- J-Link STM32 Commander (command line utility)

For more information about J-Flash, please refer to *UM08003, J-Flash User Guide*. For more information about the J-Link STM32 Commander, please refer to *J-Link STM32 Unlock (Command line tool)* on page 162.

Note: Unsecuring a secured device will cause a mass-erase of the internal flash memory.

14.16.2.4 Hardware watchdog

The hardware watchdog of a STM32F10x device can be enabled by programming the option bytes. If the hardware watchdog is enabled the device is reset periodically if the watchdog timer is not refreshed and reaches 0. If the hardware watchdog is enabled by an application which is located in flash and which does not refresh the watchdog timer, the device can not be debugged anymore.

Disabling the hardware watchdog

In order to disable the hardware watchdog the option bytes have to be re-programmed. SEGGER offers a free command line tool which reprograms the option bytes in order to disable the hardware watchdog. For more information about the STM32 commander, please refer to *J-Link STM32 Unlock (Command line tool)* on page 162.

14.16.2.5 Debugging with software watchdog enabled

If the device shall be debugged with one of the software watchdogs (independent watchdog / window watchdog) enabled, there is an additional init step necessary to make the watchdog counter stop when the CPU is halted by the debugger. This is configured in the DBGMCU_CR register. The following sequence can be used to enable debugging with software watchdogs enabled:

```
//
// Configure both watchdog timers to be halted if the CPU is halted by the debugger
//
*((volatile int *) (0xE0042004)) |= (1 << 8) | (1 << 9);
```

14.16.3 STM32F2xxx

These devices are Cortex-M3 based.
All devices of this family are supported by J-Link.

14.16.3.1 ETM init

The following sequence can be used to prepare STM32F2xxx devices for 4-bit ETM tracing:

```
int v;
//
// Enable GPIOE clock
//
*((volatile int *) (0x40023830)) = 0x00000010;
//
// Assign trace pins to alternate function in order
// to make them usable as trace pins
// PE2: Trace clock
// PE3: TRACE_D0
// PE4: TRACE_D1
// PE5: TRACE_D2
// PE6: TRACE_D3
//
*((volatile int *) (0x40021000)) = 0x00002AA0;
//
// DBGMCU_CR, enable trace I/O and configure pins for 4-bit trace.
//
v = *((volatile int *) (0xE0042004));
v &= ~(7 << 5); // Preserve all bits except the trace pin configuration
v |= (7 << 5); // Enable trace I/O and configure pins for 4-bit trace
*((volatile int *) (0xE0042004)) = v;
```

14.16.3.2 Debugging with software watchdog enabled

If the device shall be debugged with one of the software watchdogs (independent watchdog / window watchdog) enabled, there is an additional init step necessary to make the watchdog counter stop when the CPU is halted by the debugger. This is configured in the DBGMCU_APB1_FZ register. The following sequence can be used to enable debugging with software watchdogs enabled:

```
//
// Configure both watchdog timers to be halted if the CPU is halted by the debugger
//
*((volatile int *) (0xE0042008)) |= (1 << 11) | (1 << 12);
```

14.16.4 STM32F4xxx

These devices are Cortex-M4 based.
All devices of this family are supported by J-Link.

14.16.4.1 ETM init

The following sequence can be used to prepare STM32F4xxx devices for 4-bit ETM tracing:

```
int v;
//
// Enable GPIOE clock
//
*((volatile int *) (0x40023830)) = 0x00000010;
//
// Assign trace pins to alternate function in order
// to make them usable as trace pins
// PE2: Trace clock
// PE3: TRACE_D0
// PE4: TRACE_D1
// PE5: TRACE_D2
// PE6: TRACE_D3
//
*((volatile int *) (0x40021000)) = 0x00002AA0;
//
// DBGMCU_CR, enable trace I/O and configure pins for 4-bit trace.
//
v = *((volatile int *) (0xE0042004));
v &= ~(7 << 5); // Preserve all bits except the trace pin configuration
v |= (7 << 5); // Enable trace I/O and configure pins for 4-bit trace
*((volatile int *) (0xE0042004)) = v;
```

14.16.4.2 Debugging with software watchdog enabled

If the device shall be debugged with one of the software watchdogs (independent watchdog / window watchdog) enabled, there is an additional init step necessary to make the watchdog counter stop when the CPU is halted by the debugger. This is configured in the DBGMCU_APB1_FZ register. The following sequence can be used to enable debugging with software watchdogs enabled:

```
//
// Configure both watchdog timers to be halted if the CPU is halted by the debugger
//
*((volatile int *) (0xE0042008)) |= (1 << 11) | (1 << 12);
```

14.17 Texas Instruments

J-Link has been tested with the following Texas Instruments devices:

- AM3352
- AM3354
- AM3356
- AM3357
- AM3358
- AM3359
- OMAP3530
- OMAP3550
- OMAP4430
- OMAP-L138
- TMS470M
- TMS470R1A64
- TMS470R1A128
- TMS470R1A256
- TMS470R1A288
- TMS470R1A384
- TMS470R1B512
- TMS470R1B768
- TMS470R1B1M
- TMS470R1VF288
- TMS470R1VF688
- TMS470R1VF689

14.17.1 AM335x

The AM335x series devices need some special handling which requires the correct device is selected in the J-Link DLL. When used out of a debugger, this is usually done automatically (see *Software reset* on page 384). For J-Link Commander & J-Link GDBServer this needs to be done manually.

14.17.1.1 Selecting the device in the IDE

When using J-Link in an IDE, there is usually a way to directly select the device in the IDE, since it usually also needs this information for peripheral register view etc. The selected device is then usually automatically passed to the J-Link DLL.

The screenshot below is an example for a device selection inside emIDE (<http://www.emide.org>).

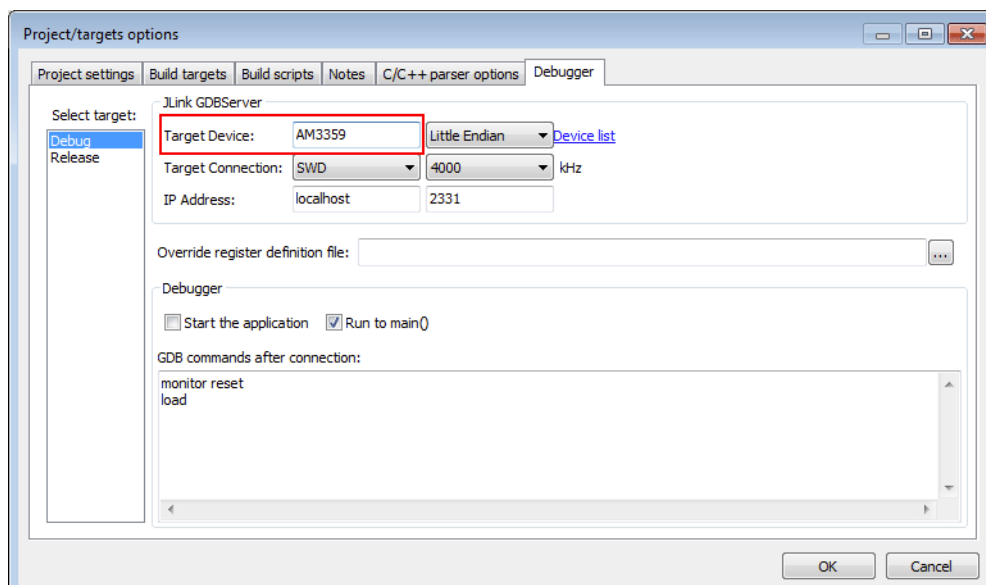

14.17.1.2 Selecting the device when using GDBServer

When using the J-Link GDBServer, the device needs to be known **before** GDB connects to the GDBServer since GDBServer connects to the device as soon as it is started. So selecting the device via monitor command is too late. In order to select the device before GDBServer connects to it, simply start it with the following command line:

```
-device <DeviceName>
Example: JLinkGDBServer -device AM3359
```

14.17.1.3 Selecting the device when using J-Link Commander

For J-Link Commander, type:

```
device <DeviceName>
```

Then J-Link Commander will perform a reconnect with the device name selected before.

14.17.1.4 Known values for <DeviceName>

For a list of all supported devices, please refer to http://www.segger.com/jlink_supported_devices.html

14.17.1.5 Required J-Link hardware version

The special handling for the AM335x cannot be supported by some older hardware versions of J-Link, so the device cannot be used with these versions.

The following hardware versions come with AM335x support:

- J-Link V8 or later
- J-Link PRO V3 or later
- J-Link ULTRA V4 or later
- Flasher ARM V4 or later

14.17.2 AM35xx / AM37xx

Script is not needed. Refer to AM335x special handling. Same needs to be done for AM35xx / AM37xx.

14.17.3 OMAP4430

Script is not needed. Refer to AM335x special handling. Same needs to be done for AM35xx / AM37xx.

14.17.4 OMAP-L138

Needs a J-Link script file to guarantee proper functionality.

J-Link script file can be found at `$JLINK_INST_DIR$\Samples\JLink\Scripts`.

For more information about how to use J-Link script files, please refer to *Executing J-Link script files* on page 230.

14.17.5 TMS470M

Needs a J-Link script file to guarantee proper functionality.

J-Link script file can be found at `$JLINK_INST_DIR$\Samples\JLink\Scripts`

For more information about how to use J-Link script files, please refer to *Executing J-Link script files* on page 230.

14.17.6 OMAP3530

Needs a J-Link script file to guarantee proper functionality.

J-Link script file can be found at `$JLINK_INST_DIR$\Samples\JLink\Scripts`

For more information about how to use J-Link script files, please refer to *Executing J-Link script files* on page 230.

14.17.7 OMAP3550

Needs a J-Link script file to guarantee proper functionality.

J-Link script file can be found at `$JLINK_INST_DIR$\Samples\JLink\Scripts`

For more information about how to use J-Link script files, please refer to *Executing J-Link script files* on page 230.

14.18 Toshiba

J-Link has been tested with the following Toshiba devices:

- TMPM321F10FG
- TMPM322F10FG
- TMPM323F10FG
- TMPM324F10FG
- TMPM330FDFG
- TMPM330FWFG
- TMPM330FYFG
- TMPM332FWUG
- TMPM333FDFG
- TMPM333FWFG
- TMPM333FYFG
- TMPM341FDXBG
- TMPM341FYXBG
- TMPM360F20FG
- TMPM361F10FG
- TMPM362F10FG
- TMPM363F10FG
- TMPM364F10FG
- TMPM366FDFG
- TMPM366FWFG
- TMPM366FYFG
- TMPM370FYDFG
- TMPM370FYFG
- TMPM372FWUG
- TMPM373FWDUG
- TMPM374FWUG
- TMPM380FWDFG
- TMPM380FWFG
- TMPM380FYDFG
- TMPM380FYFG
- TMPM382FSFG
- TMPM382FWFG
- TMPM395FWXBG

Currently, there are no specifics for these devices.

Chapter 15

Target interfaces and adapters

This chapter gives an overview about J-Link / J-Trace specific hardware details, such as the pinouts and available adapters.

15.1 20-pin J-Link connector

15.1.1 Pinout for JTAG

J-Link and J-Trace have a JTAG connector compatible to ARM's Multi-ICE. The JTAG connector is a 20 way Insulation Displacement Connector (IDC) keyed box header (2.54mm male) that mates with IDC sockets mounted on a ribbon cable.

*On later J-Link products like the J-link ULTRA, these pins are reserved for firmware extension purposes. They can be left open or connected to GND in normal debug environment. They are not essential for JTAG/SWD in general.

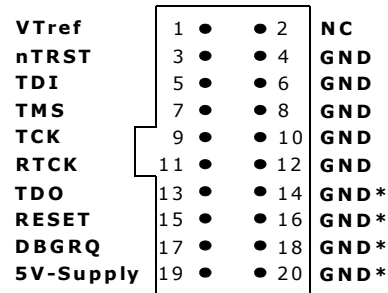

The following table lists the J-Link / J-Trace JTAG pinout.

PIN	SIGNAL	TYPE	Description
1	VTref	Input	This is the target reference voltage. It is used to check if the target has power, to create the logic-level reference for the input comparators and to control the output logic levels to the target. It is normally fed from Vdd of the target board and must not have a series resistor.
2	Not connected	NC	This pin is not connected in J-Link.
3	nTRST	Output	JTAG Reset. Output from J-Link to the Reset signal of the target JTAG port. Typically connected to nTRST of the target CPU. This pin is normally pulled HIGH on the target to avoid unintentional resets when there is no connection.
5	TDI	Output	JTAG data input of target CPU. It is recommended that this pin is pulled to a defined state on the target board. Typically connected to TDI of the target CPU.
7	TMS	Output	JTAG mode set input of target CPU. This pin should be pulled up on the target. Typically connected to TMS of the target CPU.
9	TCK	Output	JTAG clock signal to target CPU. It is recommended that this pin is pulled to a defined state of the target board. Typically connected to TCK of the target CPU.
11	RTCK	Input	Return test clock signal from the target. Some targets must synchronize the JTAG inputs to internal clocks. To assist in meeting this requirement, you can use a returned, and retimed, TCK to dynamically control the TCK rate. J-Link supports adaptive clocking, which waits for TCK changes to be echoed correctly before making further changes. Connect to RTCK if available, otherwise to GND.
13	TDO	Input	JTAG data output from target CPU. Typically connected to TDO of the target CPU.

Table 15.1: J-Link / J-Trace pinout

PIN	SIGNAL	TYPE	Description
15	RESET	I/O	Target CPU reset signal. Typically connected to the RESET pin of the target CPU, which is typically called "nRST", "nRESET" or "RESET".
17	DBGQRQ	NC	This pin is not connected in J-Link. It is reserved for compatibility with other equipment to be used as a debug request signal to the target system. Typically connected to DBGQRQ if available, otherwise left open.
19	5V-Supply	Output	This pin can be used to supply power to the target hardware. Older J-Links may not be able to supply power on this pin. For more information about how to enable/disable the power supply, please refer to <i>Target power supply</i> on page 420.

Table 15.1: J-Link / J-Trace pinout

Pins 4, 6, 8, 10, 12, 14, 16, 18, 20 are GND pins connected to GND in J-Link. They should also be connected to GND in the target system.

15.1.1.1 Target board design

We strongly advise following the recommendations given by the chip manufacturer. These recommendations are normally in line with the recommendations given in the table *Pinout for JTAG* on page 418. In case of doubt you should follow the recommendations given by the semiconductor manufacturer.

You may take any female header following the specifications of DIN 41651. For example:

Harting	part-no. 09185206803
Molex	part-no. 90635-1202
Tyco Electronics	part-no. 2-215882-0

Typical target connection for JTAG

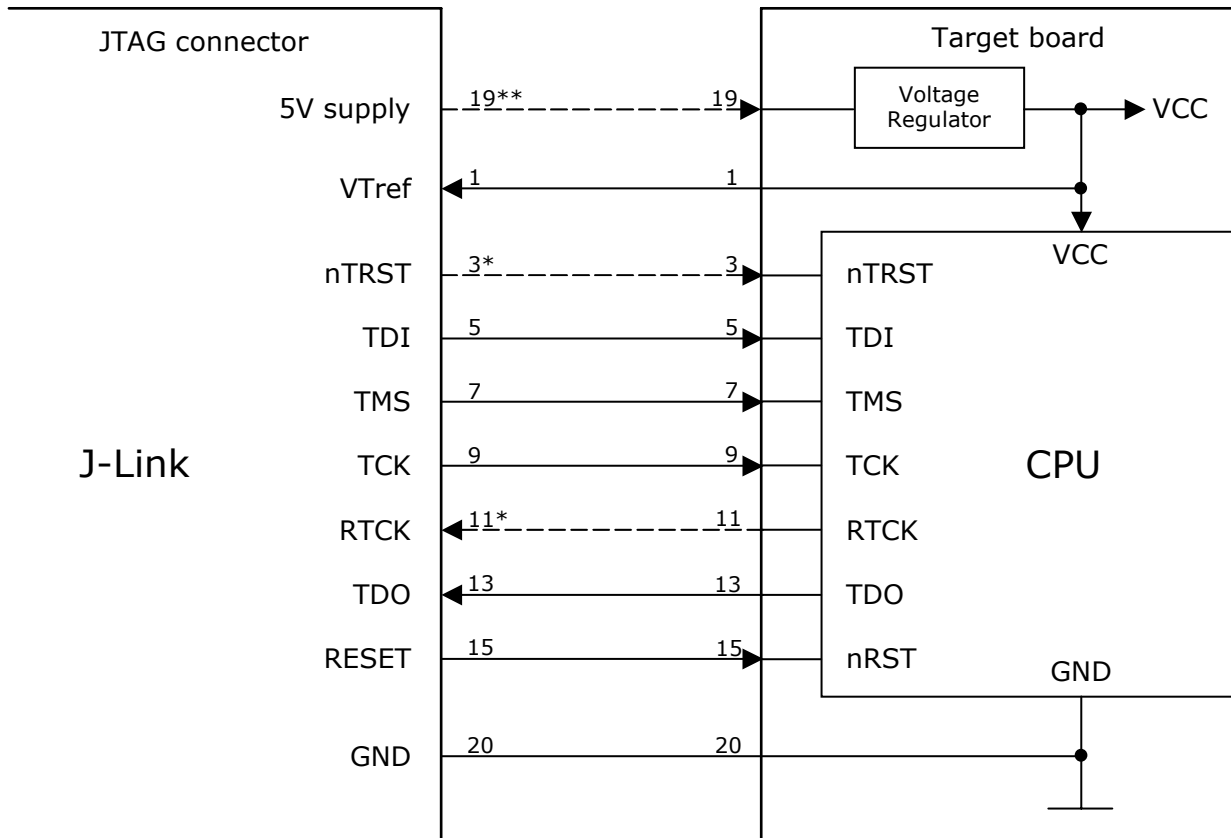

* NTRST and RTCK may not be available on some CPUs.

** Optional to supply the target board from J-Link.

15.1.1.2 Pull-up/pull-down resistors

Unless otherwise specified by developer's manual, pull-ups/pull-downs are recommended to 100 kOhms.

15.1.1.3 Target power supply

Pin 19 of the connector can be used to supply power to the target hardware. Supply voltage is 5V, max. current is 300mA. The output current is monitored and protected against overload and short-circuit. Power can be controlled via the J-Link commander. The following commands are available to control power:

Command	Explanation
<code>power on</code>	Switch target power on
<code>power off</code>	Switch target power off
<code>power on perm</code>	Set target power supply default to "on"
<code>power off perm</code>	Set target power supply default to "off"

Table 15.2: Command List

15.1.2 Pinout for SWD

The J-Link and J-Trace JTAG connector is also compatible to ARM's Serial Wire Debug (SWD).

*On later J-Link products like the J-link ULTRA, these pins are reserved for firmware extension purposes. They can be left open or connected to GND in normal debug environment. They are not essential for JTAG/SWD in general.

The following table lists the J-Link / J-Trace SWD pinout.

VTref	1 ●	● 2	NC
Not used	3 ●	● 4	GND
Not used	5 ●	● 6	GND
SWDIO	7 ●	● 8	GND
SWCLK	9 ●	● 10	GND
Not used	11 ●	● 12	GND
SWO	13 ●	● 14	GND*
RESET	15 ●	● 16	GND*
Not used	17 ●	● 18	GND*
5V-Supply	19 ●	● 20	GND*

PIN	SIGNAL	TYPE	Description
1	VTref	Input	This is the target reference voltage. It is used to check if the target has power, to create the logic-level reference for the input comparators and to control the output logic levels to the target. It is normally fed from Vdd of the target board and must not have a series resistor.
2	Not connected	NC	This pin is not connected in J-Link.
3	Not Used	NC	This pin is not used by J-Link. If the device may also be accessed via JTAG, this pin may be connected to nTRST, otherwise leave open.
5	Not used	NC	This pin is not used by J-Link. If the device may also be accessed via JTAG, this pin may be connected to TDI, otherwise leave open.
7	SWDIO	I/O	Single bi-directional data pin. A pull-up resistor is required. ARM recommends 100 kOhms.
9	SWCLK	Output	Clock signal to target CPU. It is recommended that this pin is pulled to a defined state on the target board. Typically connected to TCK of target CPU.
11	Not used	NC	This pin is not used by J-Link when operating in SWD mode. If the device may also be accessed via JTAG, this pin may be connected to RTCK, otherwise leave open.
13	SWO	Input	Serial Wire Output trace port. (Optional, not required for SWD communication.)
15	RESET	I/O	Target CPU reset signal. Typically connected to the RESET pin of the target CPU, which is typically called "nRST", "nRESET" or "RESET".
17	Not used	NC	This pin is not connected in J-Link.
19	5V-Supply	Output	This pin can be used to supply power to the target hardware. Older J-Links may not be able to supply power on this pin. For more information about how to enable/disable the power supply, please refer to <i>Target power supply</i> on page 422.

Table 15.3: J-Link / J-Trace SWD pinout

Pins 4, 6, 8, 10, 12, 14, 16, 18, 20 are GND pins connected to GND in J-Link. They should also be connected to GND in the target system.

15.1.2.1 Target board design

We strongly advise following the recommendations given by the chip manufacturer. These recommendations are normally in line with the recommendations given in the table *Pinout for SWD* on page 421. In case of doubt you should follow the recommendations given by the semiconductor manufacturer.

Typical target connection for SWD

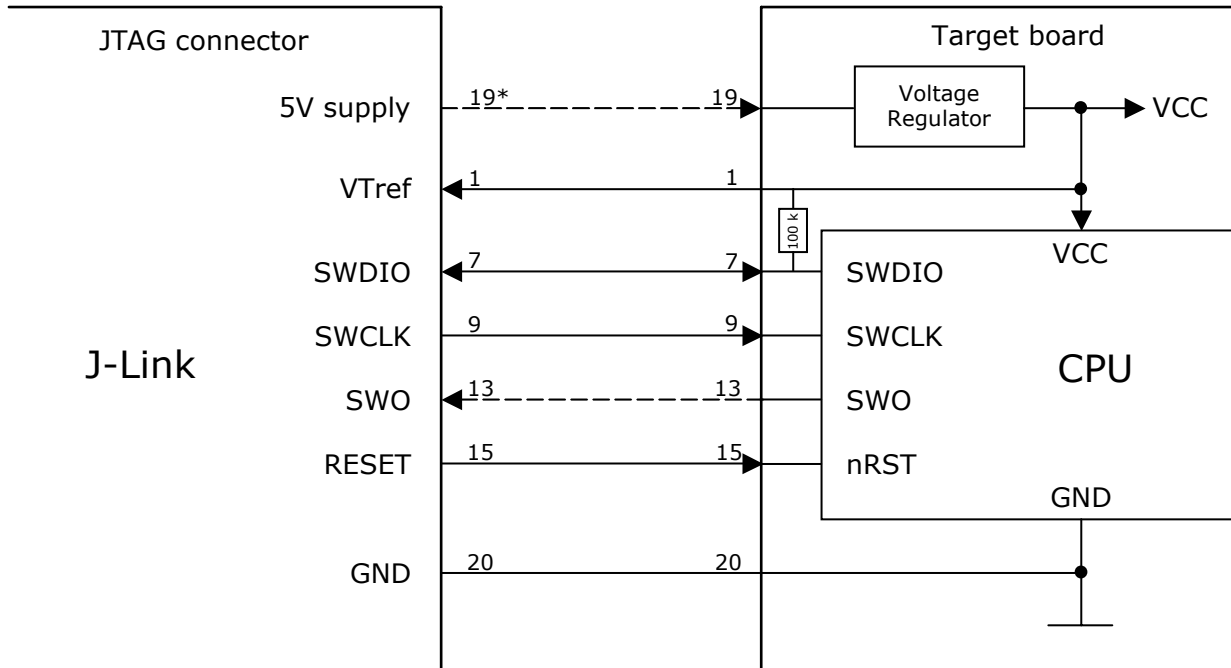

* Optional to supply the target board from J-Link.

15.1.2.2 Pull-up/pull-down resistors

A pull-up resistor is required on SWDIO on the target board. ARM recommends 100 kOhms.

In case of doubt you should follow the recommendations given by the semiconductor manufacturer.

15.1.2.3 Target power supply

Pin 19 of the connector can be used to supply power to the target hardware. Supply voltage is 5V, max. current is 300mA. The output current is monitored and protected against overload and short-circuit.

Power can be controlled via the J-Link commander. The following commands are available to control power:

Command	Explanation
<code>power on</code>	Switch target power on
<code>power off</code>	Switch target power off
<code>power on perm</code>	Set target power supply default to "on"
<code>power off perm</code>	Set target power supply default to "off"

Table 15.4: Command List

15.1.3 Pinout for SWD + Virtual COM Port (VCOM)

The J-Link and J-Trace JTAG connector is also compatible to ARM's Serial Wire Debug (SWD).

*On later J-Link products like the J-link ULTRA, these pins are reserved for firmware extension purposes. They can be left open or connected to GND in normal debug environment. They are not essential for JTAG/SWD in general.

The following table lists the J-Link / J-Trace SWD pinout.

VTref	1 ● ● 2	NC
Not used	3 ● ● 4	GND
J-Link Tx	5 ● ● 6	GND
SWDIO	7 ● ● 8	GND
SWCLK	9 ● ● 10	GND
Not used	11 ● ● 12	GND
SWO	13 ● ● 14	GND*
RESET	15 ● ● 16	GND*
J-Link Rx	17 ● ● 18	GND*
5V-Supply	19 ● ● 20	GND*

PIN	SIGNAL	TYPE	Description
1	VTref	Input	This is the target reference voltage. It is used to check if the target has power, to create the logic-level reference for the input comparators and to control the output logic levels to the target. It is normally fed from Vdd of the target board and must not have a series resistor.
2	Not connected	NC	This pin is not connected in J-Link.
3	Not Used	NC	This pin is not used by J-Link. If the device may also be accessed via JTAG, this pin may be connected to nTRST, otherwise leave open.
5	J-Link Tx	Output	This pin is used as VCOM Tx (out on J-Link side) in case VCOM functionality of J-Link is enabled. For further information about VCOM, please refer to <i>Virtual COM Port (VCOM)</i> on page 255.
7	SWDIO	I/O	Single bi-directional data pin. A pull-up resistor is required. ARM recommends 100 kOhms.
9	SWCLK	Output	Clock signal to target CPU. It is recommended that this pin is pulled to a defined state on the target board. Typically connected to TCK of target CPU.
11	Not used	NC	This pin is not used by J-Link when operating in SWD mode. If the device may also be accessed via JTAG, this pin may be connected to RTCK, otherwise leave open.
13	SWO	Input	Serial Wire Output trace port. (Optional, not required for SWD communication.)
15	RESET	I/O	Target CPU reset signal. Typically connected to the RESET pin of the target CPU, which is typically called "nRST", "nRESET" or "RESET".
17	J-Link Rx	input	This pin is used as VCOM Rx (in on J-Link side) in case VCOM functionality of J-Link is enabled. For further information, please refer to <i>Virtual COM Port (VCOM)</i> on page 255.
19	5V-Supply	Output	This pin can be used to supply power to the target hardware. Older J-Links may not be able to supply power on this pin. For more information about how to enable/disable the power supply, please refer to <i>Target power supply</i> on page 422.

Table 15.5: J-Link / J-Trace SWD pinout

Pins 4, 6, 8, 10, 12, 14, 16, 18, 20 are GND pins connected to GND in J-Link. They should also be connected to GND in the target system.

15.1.4 Pinout for SPI

*On later J-Link products like the J-link ULTRA, these pins are reserved for firmware extension purposes. They can be left open or connected to GND in normal debug environment.

VTref	1 ●	● 2	NC
NC	3 ●	● 4	GND
DI	5 ●	● 6	GND
nCS	7 ●	● 8	GND
CLK	9 ●	● 10	GND
NC	11 ●	● 12	GND
DO	13 ●	● 14	GND*
nRESET	15 ●	● 16	GND*
NC	17 ●	● 18	GND*
5V-Supply	19 ●	● 20	GND*

The following table lists the pinout for the SPI interface on J-Link.

PIN	SIGNAL	TYPE	Description
1	VTref	Input	This is the target reference voltage. It is used to check if the target has power, to create the logic-level reference for the input comparators and to control the output logic levels to the target. It is normally fed from Vdd of the target board and must not have a series resistor.
2	Not connected	NC	Leave open on target side
3	Not connected	NC	Leave open on target side
5	DI	Output	Data-input of target SPI. Output of J-Link, used to transmit data to the target SPI.
7	nCS	Output	Chip-select of target SPI (active LOW).
9	CLK	Output	SPI clock signal.
11	Not connected	NC	Leave open on target side
13	DO	Input	Data-out of target SPI. Input of J-Link, used to receive data from the target SPI.
15	RESET	I/O	Target CPU reset signal. Typically connected to the RESET pin of the target CPU, which is typically called "nRST", "nRESET" or "RESET".
17	Not connected	NC	Leave open on target side
19	5V-Supply	Output	This pin can be used to supply power to the target hardware. Older J-Links may not be able to supply power on this pin. For more information about how to enable/disable the power supply, please refer to <i>Target power supply</i> on page 420.

Table 15.6: J-Link / J-Trace pinout

Pins 4, 6, 8, 10, 12 are GND pins connected to GND in J-Link. They should also be connected to GND in the target system.

15.2 38-pin Mictor JTAG and Trace connector

J-Trace provides a JTAG+Trace connector. This connector is a 38-pin mictor plug. It connects to the target via a 1-1 cable.

The connector on the target board should be "TYCO type 5767054-1" or a compatible receptacle. J-Trace supports 4, 8, and 16-bit data port widths with the high density target connector described below.

Target board trace connector

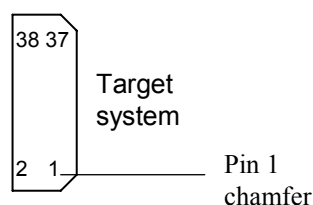

J-Trace can capture the state of signals PIPESTAT[2:0], TRACESYNC and TRACEPKT[n:0] at each rising edge of each TRACECLK or on each alternate rising or falling edge.

15.2.1 Connecting the target board

J-Trace connects to the target board via a 38-pin trace cable. This cable has a receptacle on the one side, and a plug on the other side. Alternatively J-Trace can be connected with a 20-pin JTAG cable.

Warning: Never connect trace cable and JTAG cable at the same time because this may harm your J-Trace and/or your target.

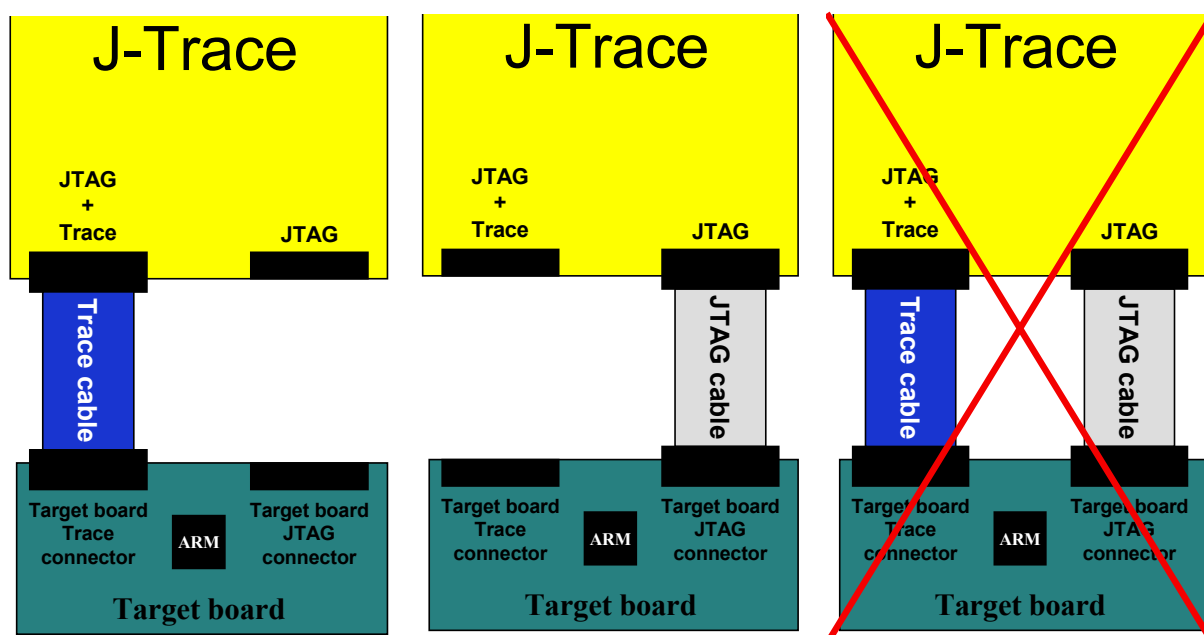

15.2.2 Pinout

The following table lists the JTAG+Trace connector pinout. It is compatible to the "Trace Port Physical Interface" described in [ETM], 8.2.2 "Single target connector pinout".

PIN	SIGNAL	Description
1	NC	Not connected.
2	NC	Not connected.
3	NC	Not connected.
4	NC	Not connected.
5	GND	Signal ground.
6	TRACECLK	Clocks trace data on rising edge or both edges.
7	DBGREQ	Debug request.
8	DBGACK	Debug acknowledge from the test chip, high when in debug state.
9	RESET	Open-collector output from the run control to the target system reset.
10	EXTTRIG	Optional external trigger signal to the Embedded trace Macrocell (ETM). Not used. Leave open on target system.
11	TDO	Test data output from target JTAG port.
12	VTRef	Signal level reference. It is normally fed from Vdd of the target board and must not have a series resistor.
13	RTCK	Return test clock from the target JTAG port.
14	VSupply	Supply voltage. It is normally fed from Vdd of the target board and must not have a series resistor.
15	TCK	Test clock to the run control unit from the JTAG port.
16	Trace signal 12	Trace signal. For more information, please refer to <i>Assignment of trace information pins between ETM architecture versions</i> on page 428.
17	TMS	Test mode select from run control to the JTAG port.
18	Trace signal 11	Trace signal. For more information, please refer to <i>Assignment of trace information pins between ETM architecture versions</i> on page 428.
19	TDI	Test data input from run control to the JTAG port.
20	Trace signal 10	Trace signal. For more information, please refer to <i>Assignment of trace information pins between ETM architecture versions</i> on page 428.
21	nTRST	Active-low JTAG reset.

Table 15.7: JTAG+Trace connector pinout

PIN	SIGNAL	Description
22	Trace signal 9	Trace signals. For more information, please refer to <i>Assignment of trace information pins between ETM architecture versions</i> on page 428.
23	Trace signal 20	
24	Trace signal 8	
25	Trace signal 19	
26	Trace signal 7	
27	Trace signal 18	
28	Trace signal 6	
29	Trace signal 17	
30	Trace signal 5	
31	Trace signal 16	
32	Trace signal 4	
33	Trace signal 15	
34	Trace signal 3	
35	Trace signal 14	
36	Trace signal 2	
37	Trace signal 13	
38	Trace signal 1	

Table 15.7: JTAG+Trace connector pinout

15.2.3 Assignment of trace information pins between ETM architecture versions

The following table show different names for the trace signals depending on the ETM architecture version.

Trace signal	ETMv1	ETMv2	ETMv3
Trace signal 1	PIPESTAT[0]	PIPESTAT[0]	TRACEDATA[0]
Trace signal 2	PIPESTAT[1]	PIPESTAT[1]	TRACECTL
Trace signal 3	PIPESTAT[2]	PIPESTAT[2]	Logic 1
Trace signal 4	TRACESYNC	PIPESTAT[3]	Logic 0
Trace signal 5	TRACEPKT[0]	TRACEPKT[0]	Logic 0
Trace signal 6	TRACEPKT[1]	TRACEPKT[1]	TRACEDATA[1]
Trace signal 7	TRACEPKT[2]	TRACEPKT[2]	TRACEDATA[2]
Trace signal 8	TRACEPKT[3]	TRACEPKT[3]	TRACEDATA[3]
Trace signal 9	TRACEPKT[4]	TRACEPKT[4]	TRACEDATA[4]
Trace signal 10	TRACEPKT[5]	TRACEPKT[5]	TRACEDATA[5]
Trace signal 11	TRACEPKT[6]	TRACEPKT[6]	TRACEDATA[6]
Trace signal 12	TRACEPKT[7]	TRACEPKT[7]	TRACEDATA[7]
Trace signal 13	TRACEPKT[8]	TRACEPKT[8]	TRACEDATA[8]
Trace signal 14	TRACEPKT[9]	TRACEPKT[9]	TRACEDATA[9]
Trace signal 15	TRACEPKT[10]	TRACEPKT[10]	TRACEDATA[10]
Trace signal 16	TRACEPKT[11]	TRACEPKT[11]	TRACEDATA[11]
Trace signal 17	TRACEPKT[12]	TRACEPKT[12]	TRACEDATA[12]
Trace signal 18	TRACEPKT[13]	TRACEPKT[13]	TRACEDATA[13]
Trace signal 19	TRACEPKT[14]	TRACEPKT[14]	TRACEDATA[14]
Trace signal 20	TRACEPKT[15]	TRACEPKT[15]	TRACEDATA[15]

Table 15.8: Assignment of trace information pins between ETM architecture versions

15.2.4 Trace signals

Data transfer is synchronized by TRACECLK.

15.2.4.1 Signal levels

The maximum capacitance presented by J-Trace at the trace port connector, including the connector and interfacing logic, is less than 6pF. The trace port lines have a matched impedance of 50.

The J-Trace unit will operate with a target board that has a supply voltage range of 3.0V-3.6V.

15.2.4.2 Clock frequency

For capturing trace port signals synchronous to TRACECLK, J-Trace supports a TRACECLK frequency of up to 200MHz. The following table shows the TRACECLK frequencies and the setup and hold timing of the trace signals with respect to TRACECLK.

Parameter	Min.	Max.	Explanation
Tperiod	5ns	1000ns	Clock period
Fmax	1MHz	200MHz	Maximum trace frequency
Tch	2.5ns	-	High pulse width
Tcl	2.5ns	-	Low pulse width
Tsh	2.5ns	-	Data setup high

Table 15.9: Clock frequency

Parameter	Min.	Max.	Explanation
Thh	1.5ns	-	Data hold high
Tsl	2.5ns	-	Data setup low
Thl	1.5ns	-	Data hold low

Table 15.9: Clock frequency

The diagram below shows the TRACECLK frequencies and the setup and hold timing of the trace signals with respect to TRACECLK.

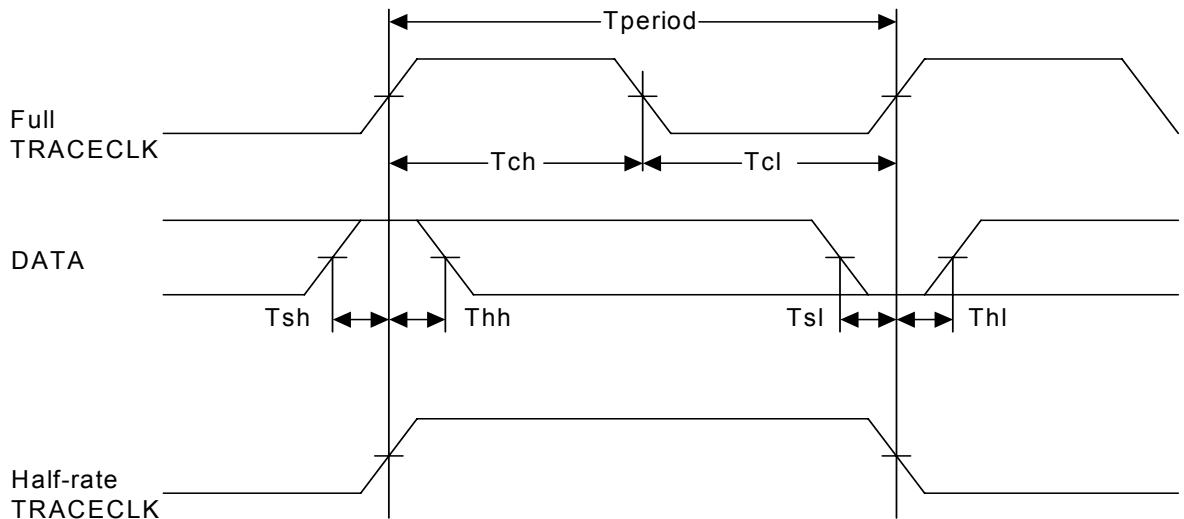

Note: J-Trace supports half-rate clocking mode. Data is output on each edge of the TRACECLK signal and $\text{TRACECLK (max)} \leq 100\text{MHz}$. For half-rate clocking, the setup and hold times at the JTAG+Trace connector must be observed.

15.3 19-pin JTAG/SWD and Trace connector

J-Trace provides a JTAG/SWD+Trace connector. This connector is a 19-pin connector. It connects to the target via an 1-1 cable.

VTref	1 ● ● 2	SWDIO/TMS
GND	3 ● ● 4	SWCLK/TCK
GND	5 ● ● 6	SWO/TDO
---	7 ● ● 8	TDI
NC	9 ● ● 10	nRESET
5V-Supply	11 ● ● 12	TRACECLK
5V-Supply	13 ● ● 14	TRACEDATA[0]
GND	15 ● ● 16	TRACEDATA[1]
GND	17 ● ● 18	TRACEDATA[2]
GND	19 ● ● 20	TRACEDATA[3]

The following table lists the J-Link / J-Trace SWD pinout.

PIN	SIGNAL	TYPE	Description
1	VTref	Input	This is the target reference voltage. It is used to check if the target has power, to create the logic-level reference for the input comparators and to control the output logic levels to the target. It is normally fed from Vdd of the target board and must not have a series resistor.
2	SWDIO/ TMS	I/O / output	SWDIO: (Single) bi-directional data pin. JTAG mode set input of target CPU. This pin should be pulled up on the target. Typically connected to TMS of the target CPU.
4	SWCLK/TCK	Output	SWCLK: Clock signal to target CPU. It is recommended that this pin is pulled to a defined state of the target board. Typically connected to TCK of target CPU. JTAG clock signal to target CPU.
6	SWO/TDO	Input	JTAG data output from target CPU. Typically connected to TDO of the target CPU. When using SWD, this pin is used as Serial Wire Output trace port. (Optional, not required for SWD communication)
---	---	---	This pin (normally pin 7) is not existent on the 19-pin JTAG/SWD and Trace connector.
8	TDI	Output	JTAG data input of target CPU. It is recommended that this pin is pulled to a defined state on the target board. Typically connected to TDI of the target CPU. For CPUs which do not provide TDI (SWD-only devices), this pin is not used. J-Link will ignore the signal on this pin when using SWD.
9	NC	NC	Not connected inside J-Link. Leave open on target hardware.
10	nRESET	I/O	Target CPU reset signal. Typically connected to the RESET pin of the target CPU, which is typically called "nRST", "nRESET" or "RESET".
11	5V-Supply	Output	This pin can be used to supply power to the target hardware. For more information about how to enable/disable the power supply, please refer to <i>Target power supply</i> on page 431.
12	TRACECLK	Input	Input trace clock. Trace clock = 1/2 CPU clock.
13	5V-Supply	Output	This pin can be used to supply power to the target hardware. For more information about how to enable/disable the power supply, please refer to <i>Target power supply</i> on page 431.
14	TRACE- DATA[0]	Input	Input Trace data pin 0.

Table 15.10: 19-pin JTAG/SWD and Trace pinout

PIN	SIGNAL	TYPE	Description
16	TRACE-DATA[1]	Input	Input Trace data pin 0.
18	TRACE-DATA[2]	Input	Input Trace data pin 0.
20	TRACE-DATA[3]	Input	Input Trace data pin 0.

Table 15.10: 19-pin JTAG/SWD and Trace pinout

Pins 3, 5, 15, 17, 19 are GND pins connected to GND in J-Trace CM3. They should also be connected to GND in the target system.

15.3.1 Target power supply

Pins 11 and 13 of the connector can be used to supply power to the target hardware. Supply voltage is 5V, max. current is 300mA. The output current is monitored and protected against overload and short-circuit.

Power can be controlled via the J-Link commander. The following commands are available to control power:

Command	Explanation
<code>power on</code>	Switch target power on
<code>power off</code>	Switch target power off
<code>power on perm</code>	Set target power supply default to "on"
<code>power off perm</code>	Set target power supply default to "off"

Table 15.11: Command List

15.4 9-pin JTAG/SWD connector

Some target boards only provide a 9-pin JTAG/SWD connector for Cortex-M. For these devices SEGGER provides a 20-pin -> 9-pin Cortex-M adapter.

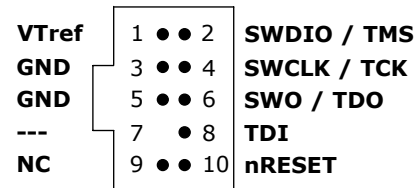

The following table lists the output of the 9-pin Cortex-M connector.

PIN	SIGNAL	TYPE	Description
1	VTref	Input	This is the target reference voltage. It is used to check if the target has power, to create the logic-level reference for the input comparators and to control the output logic levels to the target. It is normally fed from Vdd of the target board and must not have a series resistor.
2	SWDIO/ TMS	I/O / output	SWDIO: (Single) bi-directional data pin. JTAG mode set input of target CPU. This pin should be pulled up on the target. Typically connected to TMS of the target CPU.
4	SWCLK/TCK	Output	SWCLK: Clock signal to target CPU. It is recommended that this pin is pulled to a defined state of the target board. Typically connected to TCK of target CPU. JTAG clock signal to target CPU.
6	SWO/TDO	Input	When using SWD, this pin is used as Serial Wire Output trace port (optional, not required for SWD communication). JTAG data output from target CPU. Typically connected to TDO of the target CPU.
---	---	---	This pin (normally pin 7) is not existent on the 19-pin JTAG/SWD and Trace connector.
8	TDI	Output	JTAG data input of target CPU.- It is recommended that this pin is pulled to a defined state on the target board. Typically connected to TDI of the target CPU. For CPUs which do not provide TDI (SWD-only devices), this pin is not used. J-Link will ignore the signal on this pin when using SWD.
9	NC (TRST)	NC	By default, TRST is not connected, but the Cortex-M Adapter comes with a solder bridge (NR1) which allows TRST to be connected to pin 9 of the Cortex-M adapter.

Table 15.12: 9-pin JTAG/SWD pinout

Pins 3 and 5 are GND pins connected to GND on the Cortex-M adapter. They should also be connected to GND in the target system.

15.5 Reference voltage (VTref)

VTref is the target reference voltage. It is used by the J-Link to check if the target has power, to create the logic-level reference for the input comparators and to control the output logic levels to the target. It is normally fed from Vdd of the target board and must not have a series resistor.

In cases where the VTref signal should not be wired to save one more pin / place on the target hardware interface connector (e.g. in production environments), SEGGER offers a special adapter called J-Link Supply Adapter which can be used for such purposes. Further information regarding this, can be found on the SEGGER website (<https://www.segger.com/jlink-adapters-supply.html>)

To guarantee proper debug functionality, please make sure to connect at least one of the GND pins to GND (Pin 4, 6, 8, 10, 12, 14*, 16*, 18*, 20*).

Note: *On later J-Link products like the J-Link ULTRA+, these pins are reserved for firmware extension purposes. They can be left open or connected to GND in normal debug environment. They are not essential for JTAG/SWD in general.

15.6 Adapters

There are various adapters available for J-Link as for example the JTAG isolator, the J-Link RX adapter or the J-Link Cortex-M adapter.

For more information about the different adapters, please refer to <http://www.segger.com/jlink-adapters.html>.

Chapter 16

Background information

This chapter provides background information about JTAG and ARM. The ARM7 and ARM9 architecture is based on *Reduced Instruction Set Computer* (RISC) principles. The instruction set and the related decode mechanism are greatly simplified compared with microprogrammed *Complex Instruction Set Computer* (CISC).

16.1 JTAG

JTAG is the acronym for Joint Test Action Group. In the scope of this document, "the JTAG standard" means compliance with IEEE Standard 1149.1-2001.

16.1.1 Test access port (TAP)

JTAG defines a TAP (Test access port). The TAP is a general-purpose port that can provide access to many test support functions built into a component. It is composed as a minimum of the three input connections (TDI, TCK, TMS) and one output connection (TDO). An optional fourth input connection (nTRST) provides for asynchronous initialization of the test logic.

PIN	Type	Explanation
TCK	Input	The test clock input (TCK) provides the clock for the test logic.
TDI	Input	Serial test instructions and data are received by the test logic at test data input (TDI).
TMS	Input	The signal received at test mode select (TMS) is decoded by the TAP controller to control test operations.
TDO	Output	Test data output (TDO) is the serial output for test instructions and data from the test logic.
nTRST	Input (optional)	The optional test reset (nTRST) input provides for asynchronous initialization of the TAP controller.

Table 16.1: Test access port

16.1.2 Data registers

JTAG requires at least two data registers to be present: the bypass and the boundary-scan register. Other registers are allowed but are not obligatory.

Bypass data register

A single-bit register that passes information from TDI to TDO.

Boundary-scan data register

A test data register which allows the testing of board interconnections, access to input and output of components when testing their system logic and so on.

16.1.3 Instruction register

The instruction register holds the current instruction and its content is used by the TAP controller to decide which test to perform or which data register to access. It consist of at least two shift-register cells.

16.1.4 The TAP controller

The TAP controller is a synchronous finite state machine that responds to changes at the TMS and TCK signals of the TAP and controls the sequence of operations of the circuitry.

TAP controller state diagram

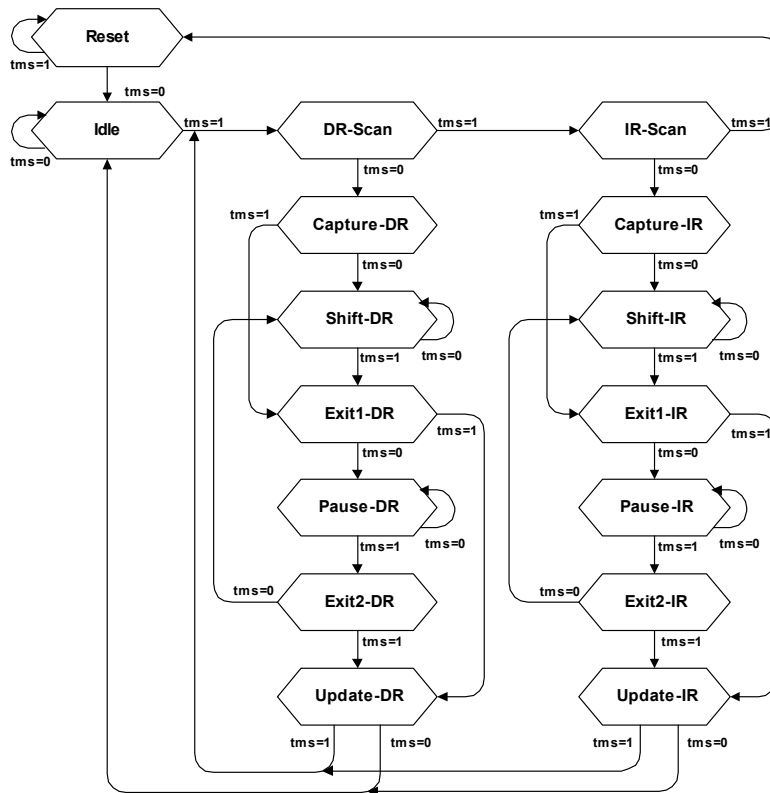

16.1.4.1 State descriptions

Reset

The test logic is disabled so that normal operation of the chip logic can continue unhindered. No matter in which state the TAP controller currently is, it can change into Reset state if TMS is high for at least 5 clock cycles. As long as TMS is high, the TAP controller remains in Reset state.

Idle

Idle is a TAP controller state between scan (DR or IR) operations. Once entered, this state remains active as long as TMS is low.

DR-Scan

Temporary controller state. If TMS remains low, a scan sequence for the selected data registers is initiated.

IR-Scan

Temporary controller state. If TMS remains low, a scan sequence for the instruction register is initiated.

Capture-DR

Data may be loaded in parallel to the selected test data registers.

Shift-DR

The test data register connected between TDI and TDO shifts data one stage towards the serial output with each clock.

Exit1-DR

Temporary controller state.

Pause-DR

The shifting of the test data register between TDI and TDO is temporarily halted.

Exit2-DR

Temporary controller state. Allows to either go back into Shift-DR state or go on to Update-DR.

Update-DR

Data contained in the currently selected data register is loaded into a latched parallel output (for registers that have such a latch). The parallel latch prevents changes at the parallel output of these registers from occurring during the shifting process.

Capture-IR

Instructions may be loaded in parallel into the instruction register.

Shift-IR

The instruction register shifts the values in the instruction register towards TDO with each clock.

Exit1-IR

Temporary controller state.

Pause-IR

Wait state that temporarily halts the instruction shifting.

Exit2-IR

Temporary controller state. Allows to either go back into Shift-IR state or go on to Update-IR.

Update-IR

The values contained in the instruction register are loaded into a latched parallel output from the shift-register path. Once latched, this new instruction becomes the current one. The parallel latch prevents changes at the parallel output of the instruction register from occurring during the shifting process.

16.2 Embedded Trace Macrocell (ETM)

Embedded Trace Macrocell (ETM) provides comprehensive debug and trace facilities for ARM processors. ETM allows to capture information on the processor's state without affecting the processor's performance. The trace information is exported immediately after it has been captured, through a special trace port.

Microcontrollers that include an ETM allow detailed program execution to be recorded and saved in real time. This information can be used to analyze program flow and execution time, perform profiling and locate software bugs that are otherwise very hard to locate. A typical situation in which code trace is extremely valuable, is to find out how and why a "program crash" occurred in case of a runaway program count.

A debugger provides the user interface to J-Trace and the stored trace data. The debugger enables all the ETM facilities and displays the trace information that has been captured. J-Trace is seamlessly integrated into the IAR Embedded Workbench® IDE. The advanced trace debugging features can be used with the IAR C-SPY debugger.

16.2.1 Trigger condition

The ETM can be configured in software to store trace information only after a specific sequence of conditions. When the trigger condition occurs the trace capture stops after a programmable period.

16.2.2 Code tracing and data tracing

Code trace

Code tracing means that the processor outputs trace data which contain information about the instructions that have been executed at last.

Data trace

Data tracing means that the processor outputs trace data about memory accesses (read / write access to which address and which data has been read / stored). In general, J-Trace supports data tracing, but it depends on the debugger if this option is available or not. Note that when using data trace, the amount of trace data to be captured rises enormously.

16.2.3 J-Trace integration example - IAR Embedded Workbench for ARM

In the following a sample integration of J-Trace and the trace functionality on the debugger side is shown. The sample is based on IAR's Embedded Workbench for ARM integration of J-Trace.

16.2.3.1 Code coverage - Disassembly tracing

The screenshot displays the IAR Embedded Workbench IDE interface. The top window shows the C source code for a microcontroller application, including system initialization, clock setup, NVIC configuration, and GPIO initialization. The middle window shows the corresponding assembly code, with instructions like ADD, POP, BLE, LDR, MOV, and STR. The bottom window is a disassembly trace table with columns for Index, Frame, Address, Opcode, Trace, and Comment, showing the execution flow of the assembly instructions.

Index	Frame	Address	Opcode	Trace	Comment
003064	003382	0x0800889E	E004	B	??NVIC_SetVectorTable_3
003065	003383	0x080088AA	4807	LDR R0, [PC, #0x1C]	assert_param(IS_NVIC_OFFSET(Offset));
003066	003384	0x080088AC	4285	CMP R5, R0	??NVIC_SetVectorTable_21
003067	003385	0x080088AE	D304	BCC	??NVIC_SetVectorTable_4
003068	003386	0x0800888A	4804	LDR R0, [PC, #0x10]	??NVIC_SetVectorTable_41
003069	003387	0x0800888C	4028	ANDS R0, R0, R5	??NVIC_SetVectorTable_42
003070	003388	0x0800888E	4320	ORRS R0, R0, R4	??NVIC_SetVectorTable_43
003071	003389	0x080088C0	4904	LDR R1, [PC, #0x10]	??NVIC_SetVectorTable_44
003072	003390	0x080088C2	6809	LDR R1, [R1]	??NVIC_SetVectorTable_45
003073	003391	0x080088C4	6088	STR R0, [R1, #0x8]	??NVIC_SetVectorTable_46
003074	003392	0x080088C6	B031	POP {R0,R4,R5,PC}	??NVIC_SetVectorTable_47
003075	003393	0x080088C2	F44F	MOV R0, #0x300	NVIC_PriorityGroupConfig(NVIC_PriorityGroup_4);
003076	003394	0x080088FC	F001	BL	NVIC_PriorityGroupConfig
003077	003395	0x0800884C	B510	PUSH {R4,LR}	void NVIC_PriorityGroupConfig(u32 NVIC_PriorityGroup)
003078	003396	0x0800884E	0004	MOV R4, R0	NVIC_PriorityGroupConfig:
003079	003397	0x08008850	F5B4	CMP R4, #0x700	assert_param(IS_NVIC_PRIORITY_GROUP(NVIC_PriorityGroup));
003080	003398	0x08008852	F5B4	CMP R4, #0x600	Not executed
003081	003399	0x08008854	F5B4	CMP R4, #0x500	Not executed
003082	003400	0x08008856	F5B4	CMP R4, #0x400	Not executed
003083	003401	0x08008858	F5B4	CMP R4, #0x300	Not executed
003084	003402	0x0800885A	F5B4	CMP R4, #0x200	Not executed
003085	003403	0x0800885C	F5B4	CMP R4, #0x100	Not executed
003086	003404	0x0800885E	F5B4	CMP R4, #0x000	Not executed
003087	003405	0x08008860	F5B4	CMP R4, #0x300	Not executed
003088	003406	0x08008862	F5B4	CMP R4, #0x200	Not executed
003089	003407	0x08008864	E004	B	??NVIC_PriorityGroupConfig_0:
003090	003408	0x0800887A	F8F0	LDR.W R0, [PC, #0x58]	??NVIC_PriorityGroupConfig_2
003091	003409	0x0800887E	6800	LDR R0, [R0]	??NVIC_PriorityGroupConfig_3
003092	003410	0x08008880	4901	LDR R1, [PC, #0x4]	??NVIC_PriorityGroupConfig_4
003093	003411	0x08008882	4321	ORRS R1, R1, R4	??NVIC_PriorityGroupConfig_5
003094	003412	0x08008884	60C1	STR R1, [R0, #0xC]	??NVIC_PriorityGroupConfig_6
003095	003413	0x08008886	B010	POP {R4,PC}	??NVIC_PriorityGroupConfig_7
003096	003414	0x08008888	4876	LDR R0, [PC, #0x108]	sysTick_SetReload(300000);

16.2.3.2 Code coverage - Source code tracing

The screenshot displays the IAR Embedded Workbench IDE interface during a source code tracing session. The main window shows the source code for a file named 'stm32f10x_nvic.c'. The code includes comments and function calls such as 'NVIC_Init()', 'NVIC_PriorityGroupConfig()', and 'GPIO_Init()'. The disassembly window on the right shows the corresponding assembly instructions, including 'BLE', 'LSRS', 'MOVVS', and 'LDR'. The trace table at the bottom provides a detailed view of the execution flow, listing the index, frame, address, opcode, trace, and comment for each instruction. The trace table shows a sequence of instructions starting from address 0x0800B5A4, with comments indicating the execution of 'RCC_GetFlagStatus(u8)', 'CLK_Init() + 66', and 'NVIC_PriorityGroupConfig(u32)'. The trace table also shows the execution of 'GPIO_InitStructure.GPIO_Pin = B1_MASK;' and 'GPIO_InitStructure.GPIO_Mode = GPIO_Mode_IN_FLOATING;'.

Index	Frame	Address	Opcode	Trace	Comment
002368	002686	0x0800B5A4	B510	RCC_GetFlagStatus(u8)	
002403	002721	0x0800B5E6	2800	CLK_Init() + 66	
002407	002725	0x0800B5A4	B510	RCC_GetFlagStatus(u8)	
002442	002760	0x0800B5E6	2800	CLK_Init() + 66	
002446	002764	0x0800B5A4	B510	RCC_GetFlagStatus(u8)	
002481	002799	0x0800B5E6	2800	CLK_Init() + 66	
002485	002803	0x0800B5A4	B510	RCC_GetFlagStatus(u8)	
002520	002838	0x0800B5E6	2800	CLK_Init() + 66	
002524	002842	0x0800B5A4	B510	RCC_GetFlagStatus(u8)	
002559	002877	0x0800B5E6	2800	CLK_Init() + 66	
002563	002881	0x0800B5A4	B510	RCC_GetFlagStatus(u8)	
002598	002916	0x0800B5E6	2800	CLK_Init() + 66	
002602	002920	0x0800B5A4	B510	RCC_GetFlagStatus(u8)	
002637	002955	0x0800B5E6	2800	CLK_Init() + 66	
002641	002959	0x0800B5A4	B510	RCC_GetFlagStatus(u8)	
002676	002994	0x0800B5E6	2800	CLK_Init() + 66	
002680	002998	0x0800B5A4	B510	RCC_GetFlagStatus(u8)	
002715	003033	0x0800B5E6	2800	CLK_Init() + 66	
002719	003037	0x0800B5A4	B510	RCC_GetFlagStatus(u8)	
002754	003072	0x0800B5E6	2800	CLK_Init() + 66	
002758	003076	0x0800B5A4	B510	RCC_GetFlagStatus(u8)	
002793	003111	0x0800B5E6	2800	CLK_Init() + 66	
002797	003115	0x0800B5A4	B510	RCC_GetFlagStatus(u8)	
002832	003150	0x0800B5E6	2800	CLK_Init() + 66	
002836	003154	0x0800B5A4	B510	RCC_GetFlagStatus(u8)	
002871	003189	0x0800B5E6	2800	CLK_Init() + 66	
002875	003193	0x0800B3C8	B510	RCC_USBCLKConfig(u32)	
002883	003201	0x0800B5C8	F44F	CLK_Init() + 76	
002885	003203	0x0800B3E8	B510	RCC_ADCLKConfig(u32)	
002906	003224	0x0800B5D0	2000	CLK_Init() + 84	
002908	003226	0x0800B37C	B510	RCC_PCLK2Config(u32)	
002923	003241	0x0800B5D6	F44F	CLK_Init() + 90	
002925	003243	0x0800B334	B510	RCC_PCLK3Config(u32)	
002942	003260	0x0800B5DE	2000	CLK_Init() + 98	
002944	003262	0x0800B2E4	B510	RCC_HCLKConfig(u32)	
002959	003277	0x0800B5E4	2002	CLK_Init() + 104	
002961	003279	0x0800D70C	B510	FLASH_SetLatency(u32)	
002985	003303	0x0800B5E4	2000	CLK_Init() + 110	
002987	003305	0x0800D746	B510	FLASH_HalfCycleAccessCmd(u32)	
003009	003327	0x0800B5F0	2010	CLK_Init() + 116	
003011	003329	0x0800D77C	B510	FLASH_PrefetchBufferCmd(u32)	
003031	003349	0x0800B5F6	2002	CLK_Init() + 122	
003033	003351	0x0800B2AC	B510	RCC_SYSClkConfig(u32)	
003053	003371	0x0800B5FC	B001	CLK_Init() + 128	
003054	003372	0x0800B5F8	2100	main() + 16	
003057	003375	0x0800B09C	B578	NVIC_SetVectorTable(u32, u32)	
003075	003393	0x0800BFC2	F44F	main() + 26	
003077	003395	0x0800B84C	B510	NVIC_PriorityGroupConfig(u32)	
003096	003414	0x0800BFCA	4876	main() + 34	

The screenshot displays the IAR Embedded Workbench IDE interface. The main window shows assembly code for a function named `NUVIC_Init`. The code includes comments describing the function's purpose: "Initializes the NUVIC peripheral according to the specified parameters in the NUVIC_InitStruct". It also shows parameter checks and the initialization of the `NUVIC_InitTypeDef` structure.

Below the code, the "Disassembly" window shows the corresponding assembly instructions, such as `MOVSB R4, #0x700` and `MOVSB R4, #0x500`, which are used to load values into registers for the NUVIC configuration.

At the bottom, the "ETM Trace" window provides a detailed execution trace. The trace table includes columns for Index, Frame, Address, Opcode, Trace, and Comment. The trace shows a sequence of instructions, including `RCC_GetFlagStatus(u8)` and `CLK_Init() + 66`, which correspond to the assembly code above. The trace ends at address `0x0000FCA` with the instruction `main() + 34`.

16.3 Embedded Trace Buffer (ETB)

The ETB is a small, circular on-chip memory area where trace information is stored during capture. It contains the data which is normally exported immediately after it has been captured from the ETM. The buffer can be read out through the JTAG port of the device once capture has been completed. No additional special trace port is required, so that the ETB can be read via J-Link. The trace functionality via J-Link is limited by the size of the ETB. While capturing runs, the trace information in the buffer will be overwritten every time the buffer size has been reached.

```

J-Link ARM
SEGGER J-Link Commander V3.72c ('?' for help)
Compiled Jul  4 2007 20:17:14
DLL version V3.72c, compiled Jul  4 2007 20:17:09
Firmware: J-Link compiled Jun 14 2007 14:36:33 ARM Rev.5
Hardware: V5.30
S/N : 1
Feature(s) : RDI, FlashBP, FlashDL, JFlash, GDB
UTarget = 3.119U
JTAG speed: 30 kHz
Info: CP15.0.0: 0x41069264: ARM, Architecture 5TEJ
Info: CP15.0.1: 0x1D192192: ICache: 32kB (4*256*32), DCache: 32kB (4*256*32)
Found 2 JTAG devices, Total IRLen = 8:
  Id of device #0: 0x1B900F0F
  Id of device #1: 0x17900F0F
Found ARM with core Id 0x17900F0F (ARM9)
  ETM V1.3: 8 pairs addr.comp, 8 data comp, 16 MM decs, 4 counters, sequencer
  ETB V1.0: 2048x24 bit RAM
J-Link>eth
ETB is present.
ID register      (ETB[0x001]) : 1B900F0F
RAM depth       (ETB[0x011]) : 00000800
RAM width       (ETB[0x021]) : 00000018
Status          (ETB[0x031]) : 00000008
RAM data        (ETB[0x041]) : 00CBB1B7
RAM read pointer (ETB[0x051]) : 00000000
RAM write pointer (ETB[0x061]) : 00000000
Trigger counter (ETB[0x071]) : 00000000
Control         (ETB[0x081]) : 00000000
J-Link>

```

The result of the limited buffer size is that not more data can be traced than the buffer can hold. Because of this limitation, an ETB is not a fully- alternative to the direct access to an ETM via J-Trace.

16.4 Flash programming

J-Link / J-Trace comes with a DLL, which allows - amongst other functionalities - reading and writing RAM, CPU registers, starting and stopping the CPU, and setting breakpoints. The standard DLL does not have API functions for flash programming. However, the functionality offered can be used to program the flash. In that case, a flashloader is required.

16.4.1 How does flash programming via J-Link / J-Trace work?

This requires extra code. This extra code typically downloads a program into the RAM of the target system, which is able to erase and program the flash. This program is called RAM code and "knows" how to program the flash; it contains an implementation of the flash programming algorithm for the particular flash. Different flash chips have different programming algorithms; the programming algorithm also depends on other things such as endianness of the target system and organization of the flash memory (for example 1 * 8 bits, 1 * 16 bits, 2 * 16 bits or 32 bits). The RAM code requires data to be programmed into the flash memory. There are 2 ways of supplying this data: Data download to RAM or data download via DCC.

16.4.2 Data download to RAM

The data (or part of it) is downloaded to another part of the RAM of the target system. The Instruction pointer (R15) of the CPU is then set to the start address of the RAM code, the CPU is started, executing the RAM code. The RAM code, which contains the programming algorithm for the flash chip, copies the data into the flash chip. The CPU is stopped after this. This process may have to be repeated until the entire data is programmed into the flash.

16.4.3 Data download via DCC

In this case, the RAM code is started as described above before downloading any data. The RAM code then communicates with the host computer (via DCC, JTAG and J-Link / J-Trace), transferring data to the target. The RAM code then programs the data into flash and waits for new data from the host. The WriteMemory functions of J-Link / J-Trace are used to transfer the RAM code only, but not to transfer the data. The CPU is started and stopped only once. Using DCC for communication is typically faster than using WriteMemory for RAM download because the overhead is lower.

16.4.4 Available options for flash programming

There are different solutions available to program internal or external flashes connected to ARM cores using J-Link / J-Trace. The different solutions have different fields of application, but of course also some overlap.

16.4.4.1 J-Flash - Complete flash programming solution

J-Flash is a stand-alone Windows application, which can read / write data files and program the flash in almost any ARM system. J-Flash requires an extra license from SEGGER.

16.4.4.2 RDI flash loader: Allows flash download from any RDI-compliant tool chain

RDI (Remote debug interface) is a standard for "debug transfer agents" such as J-Link. It allows using J-Link from any RDI compliant debugger. RDI by itself does not include download to flash. To debug in flash, you need to somehow program your application program (debuggee) into the flash. You can use J-Flash for this purpose, use the flash loader supplied by the debugger company (if they supply a matching flash loader) or use the flash loader integrated in the J-Link RDI software. The RDI software as well as the RDI flash loader require licenses from SEGGER.

16.4.4.3 Flash loader of compiler / debugger vendor such as IAR

A lot of debuggers (some of them integrated into an IDE) come with their own flash loaders. The flash loaders can of course be used if they match your flash configuration, which is something that needs to be checked with the vendor of the debugger.

16.4.4.4 Write your own flash loader

Implement your own flash loader using the functionality of the JLinkARM.dll as described above. This can be a time consuming process and requires in-depth knowledge of the flash programming algorithm used as well as of the target system.

16.5 J-Link / J-Trace firmware

The heart of J-Link / J-Trace is a microcontroller. The firmware is the software executed by the microcontroller inside of the J-Link / J-Trace. The J-Link / J-Trace firmware sometimes needs to be updated. This firmware update is performed automatically as necessary by the JLinkARM.dll.

16.5.1 Firmware update

Every time you connect to J-Link / J-Trace, JLinkARM.dll checks if its embedded firmware is newer than the one used the J-Link / J-Trace. The DLL will then update the firmware automatically. This process takes less than 3 seconds and does not require a reboot.

It is recommended that you always use the latest version of JLinkARM.dll.

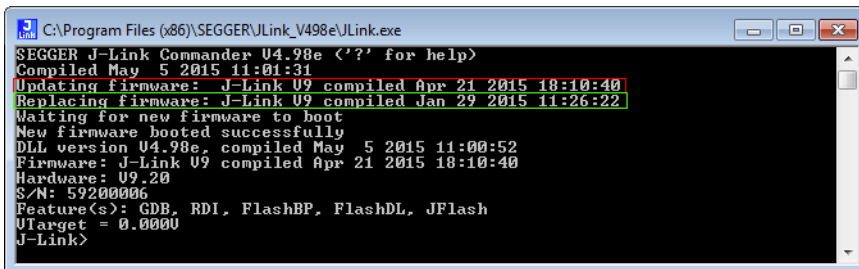

```

C:\Program Files (x86)\SEGGER\JLink_V498e\JLink.exe
SEGGER J-Link Commander U4.98e ('?' for help)
Compiled May 5 2015 11:01:31
Updating firmware: J-Link U9 compiled Apr 21 2015 18:10:40
Replacing firmware: J-Link U9 compiled Jan 29 2015 11:26:22
Waiting for new firmware to boot
New firmware booted successfully
DLL version U4.98e, compiled May 5 2015 11:00:52
Firmware: J-Link U9 compiled Apr 21 2015 18:10:40
Hardware: U9.20
S/N: 59200006
Feature(s): GDB, RDI, FlashBP, FlashDL, JFlash
UTarget = 0.0000
J-Link>
  
```

In the screenshot:

- The red box identifies the new firmware.
- The green box identifies the old firmware which has been replaced.

16.5.2 Invalidating the firmware

Downdating J-Link / J-Trace is not performed automatically through an old JLinkARM.dll. J-Link / J-Trace will continue using its current, newer firmware when using older versions of the JLinkARM.dll.

Note: Downdating J-Link / J-Trace is not recommended, you do it at your own risk!

Note: Note also the firmware embedded in older versions of JLinkARM.dll might not execute properly with newer hardware versions.

To downgrade J-Link / J-Trace, you need to invalidate the current J-Link / J-Trace firmware, using the command `exec InvalidateFW`.

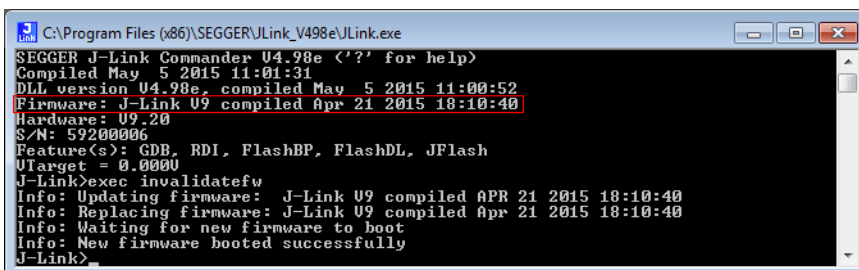

```

C:\Program Files (x86)\SEGGER\JLink_V498e\JLink.exe
SEGGER J-Link Commander U4.98e ('?' for help)
Compiled May 5 2015 11:01:31
DLL version U4.98e, compiled May 5 2015 11:00:52
Firmware: J-Link U9 compiled Apr 21 2015 18:10:40
Hardware: U9.20
S/N: 59200006
Feature(s): GDB, RDI, FlashBP, FlashDL, JFlash
UTarget = 0.0000
J-Link>exec invalidatefw
Info: Updating firmware: J-Link U9 compiled APR 21 2015 18:10:40
Info: Replacing firmware: J-Link U9 compiled Apr 21 2015 18:10:40
Info: Waiting for new firmware to boot
Info: New firmware booted successfully
J-Link>
  
```

In the screenshot, the red box contains information about the formerly used J-Link / J-Trace firmware version.

Use an application (for example `JLink.exe`) which uses the desired version of JLinkARM.dll. This automatically replaces the invalidated firmware with its embedded firmware.

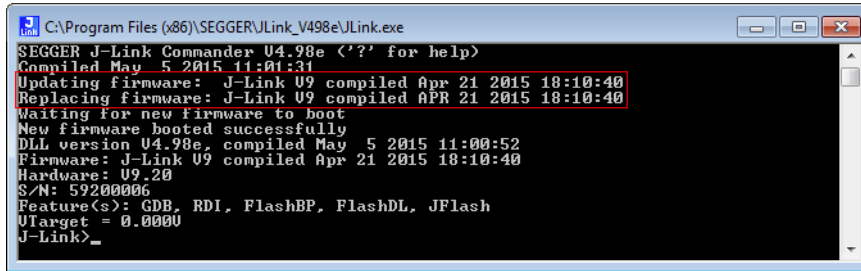

```
C:\Program Files (x86)\SEGGER\JLink_V498e\JLink.exe
SEGGER J-Link Commander V4.98e ('?' for help)
Compiled May 5 2015 11:01:31
Updating firmware: J-Link U9 compiled Apr 21 2015 18:10:40
Replacing firmware: J-Link U9 compiled APR 21 2015 18:10:40
Waiting for new firmware to boot
New firmware booted successfully
DLL version V4.98e, compiled May 5 2015 11:00:52
Firmware: J-Link U9 compiled Apr 21 2015 18:10:40
Hardware: U9_20
S/N: 59200006
Feature(s): GDB, RDI, FlashBP, FlashDL, JFlash
VTarget = 0.0000
J-Link>
```

In the screenshot:

- "Updating firmware" identifies the new firmware.
- "Replacing firmware" identifies the old firmware which has been replaced.

Chapter 17

Designing the target board for trace

This chapter describes the hardware requirements which have to be met by the target board.

17.1 Overview of high-speed board design

Failure to observe high-speed design rules when designing a target system containing an ARM Embedded Trace Macrocell (ETM) trace port can result in incorrect data being captured by J-Trace. You must give serious consideration to high-speed signals when designing the target system.

The signals coming from an ARM ETM trace port can have very fast rise and fall times, even at relatively low frequencies.

Note: These principles apply to all of the trace port signals (TRACEPKT[0:15], PIPESTAT[0:2], TRACESYNC), but special care must be taken with TRACECLK.

17.1.1 Avoiding stubs

Stubs are short pieces of track that tee off from the main track carrying the signal to, for example, a test point or a connection to an intermediate device. Stubs cause impedance discontinuities that affect signal quality and must be avoided.

Special care must therefore be taken when ETM signals are multiplexed with other pin functions and where the PCB is designed to support both functions with differing tracking requirements.

17.1.2 Minimizing Signal Skew (Balancing PCB Track Lengths)

You must attempt to match the lengths of the PCB tracks carrying all of TRACECLK, PIPESTAT, TRACESYNC, and TRACEPKT from the ASIC to the mictor connector to be within approximately 0.5 inches (12.5mm) of each other. Any greater differences directly impact the setup and hold time requirements.

17.1.3 Minimizing Crosstalk

Normal high-speed design rules must be observed. For example, do not run dynamic signals parallel to each other for any significant distance, keep them spaced well apart, and use a ground plane and so forth. Particular attention must be paid to the TRACECLK signal. If in any doubt, place grounds or static signals between the TRACECLK and any other dynamic signals.

17.1.4 Using impedance matching and termination

Termination is almost certainly necessary, but there are some circumstances where it is not required. The decision is related to track length between the ASIC and the JTAG+Trace connector, see *Terminating the trace signal* on page 451 for further reference.

17.2 Terminating the trace signal

To terminate the trace signal, you can choose between three termination options:

- Matched impedance.
- Series (source) termination.
- DC parallel termination.

Matched impedance

Where available, the best termination scheme is to have the ASIC manufacturer match the output impedance of the driver to the impedance of the PCB track on your board. This produces the best possible signal.

Series (source) termination

This method requires a resistor fitted in series with signal. The resistor value plus the output impedance of the driver must be equal to the PCB track impedance.

DC parallel termination

This requires either a single resistor to ground, or a pull-up/pull-down combination of resistors (Thevenin termination), fitted at the end of each signal and as close as possible to the JTAG+Trace connector. If a single resistor is used, its value must be set equal to the PCB track impedance. If the pull-up/pull-down combination is used, their resistance values must be selected so that their parallel combination equals the PCB track impedance.

Caution:

At lower frequencies, parallel termination requires considerably more drive capability from the ASIC than series termination and so, in practice, DC parallel termination is rarely used.

17.2.1 Rules for series terminators

Series (source) termination is the most commonly used method. The basic rules are:

1. The series resistor must be placed as close as possible to the ASIC pin (less than 0.5 inches).
2. The value of the resistor must equal the impedance of the track minus the output impedance of the output driver. So for example, a 50 PCB track driven by an output with a 17 impedance, requires a resistor value of 33.
3. A source terminated signal is only valid at the end of the signal path. At any point between the source and the end of the track, the signal appears distorted because of reflections. Any device connected between the source and the end of the signal path therefore sees the distorted signal and might not operate correctly. Care must be taken not to connect devices in this way, unless the distortion does not affect device operation.

17.3 Signal requirements

The table below lists the specifications that apply to the signals as seen at the JTAG+Trace connector.

Signal	Value
Fmax	200MHz
Ts setup time (min.)	2.0ns
Th hold time (min.)	1.0ns
TRACECLK high pulse width (min.)	1.5ns
TRACECLK high pulse width (min.)	1.5ns

Table 17.1: Signal requirements

Chapter 18

Semihosting

J-Link supports semihosting for ARM targets. This chapter explains what semihosting is, what it can be used for and how to enable semihosting in different environments.

18.1 Introduction

Semihosting is a mechanism for ARM based target devices to provide a way to communicate/interact with a host system (the PC where the debugger is running on) to allow different operations to be performed /automatized. Typical use-cases for semihosting are:

- Calls to `printf()` in the target to be forwarded to the host system and then output in a console/terminal on the host
- Calls to `scanf()` to retrieve user input entered in a console/terminal on the host and then being received and evaluated by the target
- Performing file I/O operations on the host system (reading / writing files)
- Writing a flashloader that reads the bin file to be flashed from the host system and performs the flashing operation chunk-wise

Most standard I/O libraries for embedded applications come with semihosting implementations for `printf()` and `scanf()`.

18.1.1 Advantages

- Provides standardized commands for file I/O operations on the host, allowing relatively complex operations with minimal logic in the target application
- Does not need chip-specific hardware capabilities
- Semihosting handling is natively supported by many debuggers/IDEs, for example GDB.

18.1.2 Disadvantages

- Target CPU is halted on each semihosting command, debugger evaluates the semihosting command and restarts the CPU. This affects real-time behavior of the system.

18.2 Debugger support

If semihosting is supported or not depends on the actual debugger being used. Most modern IDEs / Debuggers support semihosting. The following debuggers / IDEs are known to support semihosting:

- J-Link Debugger
- J-Link GDBServer + GDB
- SEGGER Embedded Studio
- J-Link RDI (and therefor most RDI compliant debuggers)
- IAR Embedded Workbench for ARM
- Keil MDK-ARM
- ARM AXD

18.3 Implementation

In general, there are two ways of implement semihosting which are explained in the following:

- SVC instruction (called SWI on legacy CPUs)
- Breakpoint instruction
- J-Link GDBServer optimized version

18.3.1 SVC instruction

Inside `printf()` calls etc. that shall perform semihosting, an SVC instruction is present which causes the CPU to issue a software interrupt and jump to the SVC exception handler. The debugger usually sets a breakpoint on the first instruction of the SVC exception handler or sets a vector catch that has the same effect but does not waste one hardware breakpoint. If vector catch is available depends on the CPU. Once the CPU has been halted, the debugger can identify the cause of the SVC exception by analyzing the SVC instruction that caused the exception. In the instruction there is a SVC reason/number encoded. The number may differ if the CPU was in ARM or Thumb mode when the SVC instruction was executed. The following SVC reasons are reserved for semihosting:

- ARM mode: 0x123456
- Thumb mode: 0xAB

Once the debugger has performed the semihosting operation and evaluated the command, it will restart the target CPU right behind the SVC instruction that caused the semihosting call. So it is debuggers responsibility to perform the exception return.

Disadvantages

If the SVC instruction is also used by the user application or a operating system on the target, the CPU will be halted on every semihosting exception and be restarted by the debugger. This affects real-time behavior of the target application.

18.3.2 Breakpoint instruction

A breakpoint instruction is compiled into the code that makes use of semihosting (usually somewhere inside the `printf()` function in a library). The CPU halts as soon as the breakpoint instruction is hit and allows the debugger to perform semihosting operations. Once the CPU has been halted, the debugger is able to determine the halt reason by analyzing the breakpoint instruction that caused the halt. In the breakpoint instruction, a "halt reason" can be encoded. The halt reason may differ if the breakpoint instruction is an ARM instruction or Thumb instruction. The following halt reasons are reserved for semihosting:

- ARM mode: 0x123456
- Thumb mode: 0xAB

Disadvantages

Having a breakpoint instruction compiled in a library call will make it necessary to have different compile options for debug and release configurations as the target application will not run stand-alone, without debugger intervention.

18.3.3 J-Link GDBServer optimized version

When using J-Link GDBServer with a GDB-based environment, there is a third implementation for semihosting available which is a hybrid of the other implementations, combining the advantages of both. With this implementation, an SVC instruction with the usual SVC reason is used to issue a semihosting call but the debugger does not set a breakpoint or vector catch on the start of the SVC exception handler. Instead, the SVC exception handler provides some code that detects if the reason was a semihosting call, if yes it immediately performs a return from exception on which the debugger has set a hardware breakpoint. This allows the application to continue nor-

mally in case no debugger is connected and handling the semihosting call. It also inhibits the CPU from being halted on each non-semihosting call, preserving the real-time behavior of the target application.

Advantages

Application also runs stand-alone (no debugger connected).

Real-time behavior of the application is preserved.

Disadvantages

One hardware breakpoint is not available for debugging / stepping as it is permanently used while semihosting is enabled.

Only works with J-Link GDBServer as other debuggers do not support this specialized version.

18.3.3.1 SVC exception handler sample code

In the following, some sample code for the SVC handler, prepared to be used with J-Link GDBServer optimized semihosting, is given:

SVC_Handler:

```

;
; For semihosting R0 and R1 contain the semihosting information and may not
; be changed before semihosting is handled.
; If R2 and R3 contain values for the SVC handler or need to be restored for
; the calling function, save them on the stack.
;
#ifdef SAVE_REGS_IN_SVC
    PUSH    {R2,R3}
#endif
    BIC     R2, LR, #0xFFFFFFFF
    CMP     R2, #0x01           ; Check whether we come from Thumb or ARM mode
    BNE     CheckSemiARM
CheckSemiThumb:
#ifdef BIG_ENDIAN
    LDRB    R2, [LR, #-2]
#else
    LDRB    R2, [LR, #-1]
#endif
    LDR     R3, _DataTable2
    CMP     R2, R3           ; ARM semihosting call?
    BNE     DoSVC
    B       SemiBreak
CheckSemiARM:
    LDR     R2, [LR, #-4]
    BIC     R2, R2, #0xFF000000
    LDR     R3, _DataTable1
    CMP     R2, R3           ; Thumb semihosting call?
    BNE     DoSVC
#ifdef SAVE_REGS_IN_SVC
    POP     {R2,R3}         ; Restore regs needed for semihosting
#endif
SemiBreak:           ; Debugger will set a breakpoint here and perform exception return
    NOP
    MOVS   R0, #+0         ; Make sure we have a valid return value in case
    BX     LR              ; debugger is not connected
DoSVC:
;
; Customer specific SVC handler code
;
    MOVS   R0, #+0         ; Replace this code with your SVC Handler
    BX     LR

_DataTable1:
    .word  0x00123456
_DataTable2:
    .byte  0xAB
    .byte  0x00
    .byte  0x00
    .byte  0x00

```

18.4 Communication protocol

Semihosting defines a standardized set of semihosting commands that need to be supported by a debugger, claiming that it supports semihosting. In the following, the communication protocol for semihosting as well as the specified commands are explained.

18.4.1 Register R0

Right before the operation that halts the CPU for semihosting, is performed, the target application needs to prepare CPU register R0 and (depending on the command) also some other CPU registers.

On halt, R0 will hold the semihosting command, so the debugger can determine further parameters and operation to be performed, from it.

18.4.2 Command SYS_OPEN (0x01)

Opens a file on the host system.

Register R1 holds a pointer to an address on the target, that specifies a 3-word (32-bit each) buffer where additional information for the command can be found.

Word 0

Pointer to a null-terminated string that specifies the file to open.

Special: The string ":tt" specifies the console input/output (usually stdin / stdout). Which one is selected depends on if the stream is opened for reading or writing.

Word 1

A number that specifies how the file is to be opened (reading/writing/appending etc.). In the following, the corresponding ISO C fopen() modes for the numbers are listed.

Word1	ISO C fopen() mode
0	r
1	rb
2	r+
3	r+b
4	w
5	wb
6	w+
7	w+b
8	a
9	ab
10	a+
11	a+b

Table 18.1: ISO C fopen() modes

Word 2

Integer that specifies the length of the string (excluding the terminating null character) pointed to by word 0.

Return value

Operation result is written to register R0 by the debugger.

!= 0 O.K., handle of the file (needed for SYS_CLOSE etc.)
 == -1 Error

18.4.3 Command **SYS_CLOSE (0x02)**

Closes a file on the host system.

Register R1 holds a pointer to an address on the target, that specifies a 1-word (32-bit each) buffer where additional information for the command can be found.

Word 0

Handle of the file retrieved on `SYS_OPEN`

Return value

Operation result is written to register R0 by the debugger.

```
== 0   O.K.
== -1  Error
```

18.4.4 Command **SYS_WRITEC (0x03)**

Writes a single character to the debug channel on the host system (stdout in most cases).

Register R1 holds a pointer to an address on the target, that specifies a 1-word (32-bit each) buffer where additional information for the command can be found.

Word 0

Pointer to the character to be written.

Return value

None

18.4.5 Command **SYS_WRITE0 (0x04)**

Writes a null-terminated string (excluding the null character) to the debug channel on the host system.

Register R1 holds a pointer to the string that shall be written.

Return value

None

18.4.6 Command **SYS_WRITE (0x05)**

Writes a given number of bytes to a file that has been previously opened via `SYS_OPEN`. Exceptions: Handle 0-2 which specify stdin, stdout, stderr (in this order) do not require to be opened with `SYS_OPEN` before used. This command behaves compatible to the ANSI C function `fwrite()` meaning that writing is started at the last position of the write pointer on the host.

Register R1 holds a pointer to an address on the target, that specifies a 3-word (32-bit each) buffer where additional information for the command can be found.

Word 0

Handle of the file to be written.

Word 1

Pointer to the data on the target, to be written.

Word 2

Number of bytes to write

Return value

Operation result is written to register R0 by the debugger.

== 0 O.K.

!= 0 Number of bytes to write left (in case not all bytes could be written)

18.4.7 Command SYS_READ (0x06)

Reads a given number of bytes from a file that has been previously opened via `SYS_OPEN`. Exceptions: Handle 0-2 which specify `stdin`, `stdout`, `stderr` (in this order) do not require to be opened with `SYS_OPEN` before used. This command behaves compatible to the ANSI C function `fread()` meaning that reading is started at the last position of the read pointer on the host.

Register R1 holds a pointer to an address on the target, that specifies a 3-word (32-bit each) buffer where additional information for the command can be found.

Word 0

Handle of the file to be read.

Word 1

Pointer to a buffer on the target where data from file is written to.

Word 2

Number of bytes to read

Return value

Operation result is written to register R0 by the debugger.

== 0 O.K.

!= 0 Number of bytes to read left (in case not all bytes could be read). If identical to the number of bytes to be read, read pointer was pointing to end-of-file and no bytes have been read.

18.4.8 Command SYS_READC (0x07)

Reads a single character from the debug channel on the host (usually `stdin`).

Register R1 is set to 0.

Return value

Character that has been read is written to register R0.

18.4.9 Command SYS_ISTTY (0x09)

Checks if a given handle is an "interactive device" (`stdin`, `stdout`, ...).

Register R1 holds a pointer to an address on the target, that specifies a 1-word (32-bit each) buffer where additional information for the command can be found.

Word 0

Handle of the file to be checked.

Return value

Operation result is written to register R0 by the debugger.

== 1 O.K., given handle is an interactive device.

== 0 O.K., given handle is not an interactive device.

Else Error

18.4.10 Command **SYS_SEEK (0x0A)**

Moves the filepointer of a file previously opened via `SYS_OPEN` to a specific position in the file. Behaves compliant to the ANSI C function `fseek()`.

Register R1 holds a pointer to an address on the target, that specifies a 2-word (32-bit each) buffer where additional information for the command can be found.

Word 0

Handle of the file.

Word 1

Position of the filepointer inside the file, to set to.

Return value

Operation result is written to register R0 by the debugger.

```
== 0   O.K.
!= 0   Error.
```

18.4.11 Command **SYS_FLEN (0x0C)**

Retrieves the size of a file, previously opened by `SYS_OPEN`, in bytes.

Register R1 holds a pointer to an address on the target, that specifies a 1-word (32-bit each) buffer where additional information for the command can be found.

Word 0

Handle of the file.

Return value

Operation result is written to register R0 by the debugger.

```
>= 0   File size in bytes
== -1   Error.
```

18.4.12 Command **SYS_REMOVE (0x0E)**

Deletes a file on the host system.

Register R1 holds a pointer to an address on the target, that specifies a 2-word (32-bit each) buffer where additional information for the command can be found.

Word 0

Pointer to a null-terminated string that specifies the path + file to be deleted.

Word 1

Length of the string pointed to by `word 0`.

Return value

Operation result is written to register R0 by the debugger.

```
== 0   O.K.
!= 0   Error.
```

18.4.13 Command **SYS_RENAME (0x0F)**

Renames a file on the host system.

Register R1 holds a pointer to an address on the target, that specifies a 4-word (32-bit each) buffer where additional information for the command can be found.

Word 0

Pointer to a null-terminated string that specifies the old name of the file.

Word 1

Length of the string (without terminating null-character) pointed to by `word 0`.

Word 2

Pointer to a null-terminated string that specifies the new name of the file.

Word 3

Length of the string (without terminating null-character) pointed to by `word 2`.

Return value

Operation result is written to register R0 by the debugger.

```
== 0   O.K.
!= 0   Error.
```

18.4.14 Command SYS_GET_CMDLINE (0x15)

Gets the command line (`argc`, `argv`) from the process on the host system as a single string. `argv` elements will be separated by spaces.

Register R1 holds a pointer to an address on the target, that specifies a 2-word (32-bit each) buffer where additional information for the command can be found.

Word 0

Pointer to a buffer on the target system to store the command line to.

Word 1

Size of the buffer in bytes.

Return value

After the operation, `word 1` will hold the length of the command line string.

Operation result is written to register R0 by the debugger.

```
== 0   O.K.
!= 0   Error.
```

18.4.15 Command SYS_EXIT (0x18)

Used to tell the debugger if an application exited/completed with success or error. Usually, this also ends the debug session automatically.

Register R1 is one of the following values:

Exit code	Meaning
0x20026	Application exited normally.
0x20023	Application exited with error.

Table 18.2: SYS_EXIT exit codes

Return value

None.

18.5 Enabling semihosting in J-Link GDBServer

By default, semihosting is disabled in J-Link GDBServer. Depending on the mechanism to be used, different setups are necessary

18.5.1 SVC variant

The following commands need to be added to the gdbinit file that is executed at the start of a debug session:

```
monitor semihosting enable
monitor semihosting breakOnError
monitor semihosting IOclient 3
monitor semihosting setargs "<argv>" (in case SYS_GET_CMDLINE command is used)
```

For more detailed information about the monitor commands supported by J-Link GDBServer, please refer to *Supported remote (monitor) commands* on page 110.

18.5.2 Breakpoint variant

The following commands need to be added to the gdbinit file that is executed at the start of a debug session:

```
monitor semihosting enable
```

18.5.3 J-Link GDBServer optimized variant

The following commands need to be added to the gdbinit file that is executed at the start of a debug session:

```
monitor semihosting enable <AddrSemiBreak>
```

Please also make sure that an appropriate SVC exception handler is linked in the application. For sample code, please refer to *SVC exception handler sample code* on page 457.

18.6 Enabling Semihosting in J-Link RDI + AXD

This semihosting mechanism can be disabled or changed by the following debugger internal variables:

\$semihosting_enabled

Set this variable to 0 to disable semihosting. If you are debugging an application running from ROM, this allows you to use an additional watchpoint unit.

Set this variable to 1 to enable semihosting. This is the default.

Set this variable to 2 to enable Debug Communications Channel (DCC) semihosting. The S bit in \$vector_catch has no effect unless semihosting is disabled.

\$semihosting_vector

This variable controls the location of the breakpoint set by J-Link RDI to detect a semihosted SWI. It is set to the SWI entry in the exception vector table () by default.

18.6.0.1 Using SWIs in your application

If your application requires semihosting as well as having its own SWI handler, set \$semihosting_vector to an address in your SWI handler. This address must point to an instruction that is only executed if your SWI handler has identified a call to a semihosting SWI. All registers must already have been restored to whatever values they had on entry to your SWI handler.

Chapter 19

Support and FAQs

This chapter contains troubleshooting tips as well as solutions for common problems which might occur when using J-Link / J-Trace. There are several steps you can take before contacting support. Performing these steps can solve many problems and often eliminates the need for assistance. This chapter also contains a collection of frequently asked questions (FAQs) with answers.

19.1 Measuring download speed

19.1.1 Test environment

JLink.exe has been used for measurement performance. The hardware consisted of:

- PC with 2.6 GHz Pentium 4, running Win2K
- USB 2.0 port
- USB 2.0 hub
- J-Link
- Target with ARM7 running at 50MHz

Below is a screenshot of JLink.exe after the measurement has been performed.

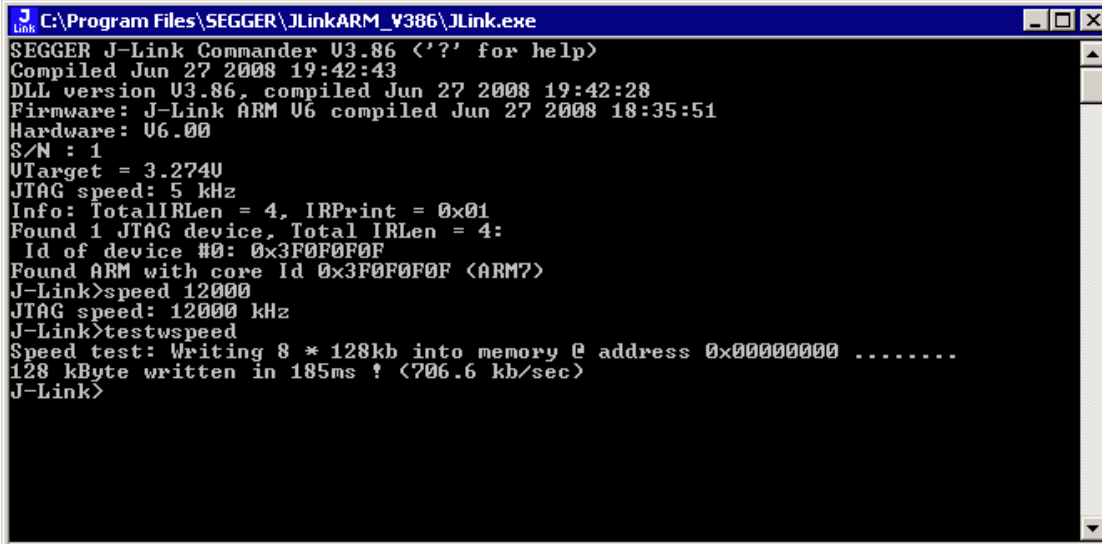

```
C:\Program Files\SEGGER\JLinkARM_V386\JLink.exe
SEGGER J-Link Commander V3.86 <'?' for help>
Compiled Jun 27 2008 19:42:43
DLL version V3.86, compiled Jun 27 2008 19:42:28
Firmware: J-Link ARM V6 compiled Jun 27 2008 18:35:51
Hardware: V6.00
S/N : 1
VTarget = 3.274U
JTAG speed: 5 kHz
Info: TotalIRLen = 4, IRPrint = 0x01
Found 1 JTAG device, Total IRLen = 4:
  Id of device #0: 0x3F0F0F0F
Found ARM with core Id 0x3F0F0F0F <ARM7>
J-Link>speed 12000
JTAG speed: 12000 kHz
J-Link>testwspeed
Speed test: Writing 8 * 128kb into memory @ address 0x00000000 .....
128 kByte written in 185ms ! <706.6 kb/sec>
J-Link>
```

19.2 Troubleshooting

19.2.1 General procedure

If you experience problems with J-Link / J-Trace, you should follow the steps below to solve these problems:

1. Close all running applications on your host system.
2. Disconnect the J-Link / J-Trace device from USB.
3. Disable power supply on the target.
4. Re-connect J-Link / J-Trace with the host system (attach USB cable).
5. Enable power supply on the target.
6. Try your target application again. If the problem remains continue the following procedure.
7. Close all running applications on your host system again.
8. Disconnect the J-Link / J-Trace device from USB.
9. Disable power supply on the target.
10. Re-connect J-Link / J-Trace with the host system (attach the USB cable).
11. Enable power supply on the target.
12. Start `JLink.exe`.
13. If `JLink.exe` displays the J-Link / J-Trace serial number and the target processor's core ID, the J-Link / J-Trace is working properly and cannot be the cause of your problem.
14. If the problem persists and you own an original product (not an OEM version), see section *Contacting support* on page 469.

19.2.2 Typical problem scenarios

J-Link / J-Trace LED is off

Meaning:

The USB connection does not work.

Remedy:

Check the USB connection. Try to re-initialize J-Link / J-Trace by disconnecting and reconnecting it. Make sure that the connectors are firmly attached. Check the cable connections on your J-Link / J-Trace and the host computer. If this does not solve the problem, check if your cable is defective. If the USB cable is ok, try a different host computer.

J-Link / J-Trace LED is flashing at a high frequency

Meaning:

J-Link / J-Trace could not be enumerated by the USB controller.

Most likely reasons:

- a.) Another program is already using J-Link / J-Trace.
- b.) The J-Link USB driver does not work correctly.

Remedy:

- a.) Close all running applications and try to reinitialize J-Link / J-Trace by disconnecting and reconnecting it.
- b.) If the LED blinks permanently, check the correct installation of the J-Link USB driver. Deinstall and reinstall the driver as shown in chapter *Setup* on page 167.

J-Link/J-Trace does not get any connection to the target**Most likely reasons:**

- a.) The JTAG cable is defective.
- b.) The target hardware is defective.

Remedy:

Follow the steps described in *General procedure* on page 467.

19.3 Contacting support

Before contacting support, make sure you tried to solve your problem by following the steps outlined in section *General procedure* on page 467. You may also try your J-Link / J-Trace with another PC and if possible with another target system to see if it works there. If the device functions correctly, the USB setup on the original machine or your target hardware is the source of the problem, not J-Link / J-Trace.

If you need to contact support, send the following information to support@segger.com:

- A detailed description of the problem.
- J-Link/J-Trace serial number.
- Output of `JLink.exe` if available.
- Your findings of the signal analysis.
- Information about your target hardware (processor, board, etc.).

J-Link / J-Trace is sold directly by SEGGER or as OEM-product by other vendors. We can support only official SEGGER products.

19.4 Frequently Asked Questions

Supported CPUs

Q: Which CPUs are supported?

A: J-Link / J-Trace should work with any ARM7/9 and Cortex-M3 core. For a list of supported cores, see section *Supported CPU cores* on page 60.

Converting data files

Q: I want to download my application into flash memory using J-Link Commander but my application is a *.hex data file and J-Link Commander supports *.bin files only. How do I download it?

A: Please use the J-Flash (which is part of the J-Link software and documentation package) software to convert your *.hex/*.mot/... file to a *.bin file. For data file conversion, no J-Flash license is necessary.

Using J-Link in my application

Q: I want to write my own application and use J-Link / J-Trace. Is this possible?

A: Yes. We offer a dedicated Software Developer Kit (SDK). See section *J-Link Software Developer Kit (SDK)* on page 165 for further information.

Using DCC with J-Link

Q: Can I use J-Link / J-Trace to communicate with a running target via DCC?

A: Yes. The DLL includes functions to communicate via DCC on cores which support DCC, such as ARM7/9/11, Cortex A/R series.

Read status of JTAG pins

Q: Can J-Link / J-Trace read back the status of the JTAG pins?

A: Yes, the status of all pins can be read. This includes the outputs of J-Link / J-Trace as well as the supply voltage, which can be useful to detect hardware problems on the target system.

J-Link support of ETM

Q: Does J-Link support the Embedded Trace Macrocell (ETM)?

A: No. ETM requires another connection to the ARM chip and a CPU with built-in ETM. Most current ARM7 / ARM9 chips do not have ETM built-in.

J-Link support of ETB

Q: Does J-Link support the Embedded Trace Buffer (ETB)?

A: Yes. J-Link supports ETB. Most current ARM7 / ARM9 chips do not have ETB built-in.

Registers on ARM 7 / ARM 9 targets

Q: I'm running `J-Link.exe` in parallel to my debugger, on an ARM 7 target. I can read memory okay, but the processor registers are different. Is this normal?

A: If memory on an ARM 7/9 target is read or written the processor registers are modified. When memory read or write operations are performed, J-Link preserves the register values before they are modified. The register values shown in the debugger's register window are the preserved ones. If a second instance, in this case `J-Link.exe`, reads the processor registers, it reads the values from the hardware, which are the modified ones. This is why it shows different register values.

Chapter 20

Glossary

This chapter describes important terms used throughout this manual.

Adaptive clocking

A technique in which a clock signal is sent out by J-Link / J-Trace. J-Link / J-Trace waits for the returned clock before generating the next clock pulse. The technique allows the J-Link / J-Trace interface unit to adapt to differing signal drive capabilities and differing cable lengths.

Application Program Interface

A specification of a set of procedures, functions, data structures, and constants that are used to interface two or more software components together.

Big-endian

Memory organization where the least significant byte of a word is at a higher address than the most significant byte. See Little-endian.

Cache cleaning

The process of writing dirty data in a cache to main memory.

Coprocessor

An additional processor that is used for certain operations, for example, for floating-point math calculations, signal processing, or memory management.

Dirty data

When referring to a processor data cache, data that has been written to the cache but has not been written to main memory is referred to as dirty data. Only write-back caches can have dirty data because a write-through cache writes data to the cache and to main memory simultaneously. See also cache cleaning.

Dynamic Linked Library (DLL)

A collection of programs, any of which can be called when needed by an executing program. A small program that helps a larger program communicate with a device such as a printer or keyboard is often packaged as a DLL.

Embedded Trace Macrocell (ETM)

ETM is additional hardware provided by debuggable ARM processors to aid debugging with trace functionality.

Embedded Trace Buffer (ETB)

ETB is a small, circular on-chip memory area where trace information is stored during capture.

EmbeddedICE

The additional hardware provided by debuggable ARM processors to aid debugging.

Halfword

A 16-bit unit of information. Contents are taken as being an `unsigned integer` unless otherwise stated.

Host

A computer which provides data and other services to another computer. Especially, a computer providing debugging services to a target being debugged.

ICache

Instruction cache.

ICE Extension Unit

A hardware extension to the EmbeddedICE logic that provides more breakpoint units.

ID

Identifier.

IEEE 1149.1

The IEEE Standard which defines TAP. Commonly (but incorrectly) referred to as JTAG.

Image

An executable file that has been loaded onto a processor for execution.

In-Circuit Emulator (ICE)

A device enabling access to and modification of the signals of a circuit while that circuit is operating.

Instruction Register

When referring to a TAP controller, a register that controls the operation of the TAP.

IR

See Instruction Register.

Joint Test Action Group (JTAG)

The name of the standards group which created the IEEE 1149.1 specification.

Little-endian

Memory organization where the least significant byte of a word is at a lower address than the most significant byte. See also Big-endian.

Memory coherency

A memory is coherent if the value read by a data read or instruction fetch is the value that was most recently written to that location. Obtaining memory coherency is difficult when there are multiple possible physical locations that are involved, such as a system that has main memory, a write buffer, and a cache.

Memory management unit (MMU)

Hardware that controls caches and access permissions to blocks of memory, and translates virtual to physical addresses.

Memory Protection Unit (MPU)

Hardware that controls access permissions to blocks of memory. Unlike an MMU, an MPU does not translate virtual addresses to physical addresses.

Multi-ICE

Multi-processor EmbeddedICE interface. ARM registered trademark.

RESET

Abbreviation of System Reset. The electronic signal which causes the target system other than the TAP controller to be reset. This signal is also known as "nSRST", "nSYSRST", "nRST", or "nRESET" in some other manuals. See also nTRST.

nTRST

Abbreviation of TAP Reset. The electronic signal that causes the target system TAP controller to be reset. This signal is known as nICERST in some other manuals. See also nSRST.

Open collector

A signal that may be actively driven LOW by one or more drivers, and is otherwise passively pulled HIGH. Also known as a "wired AND" signal.

Processor Core

The part of a microprocessor that reads instructions from memory and executes them, including the instruction fetch unit, arithmetic and logic unit, and the register bank. It excludes optional coprocessors, caches, and the memory management unit.

Program Status Register (PSR)

Contains some information about the current program and some information about the current processor state. Therefore often referred to as Processor Status Register.

Also referred to as Current PSR (CPSR), to emphasize the distinction to the Saved PSR (SPSR). The SPSR holds the value the PSR had when the current function was called, and which will be restored when control is returned.

Remapping

Changing the address of physical memory or devices after the application has started executing. This is typically done to make RAM replace ROM once the initialization has been done.

Remote Debug Interface (RDI)

RDI is an open ARM standard procedural interface between a debugger and the debug agent. The widest possible adoption of this standard is encouraged.

RTCK

Returned TCK. The signal which enables Adaptive Clocking.

RTOS

Real Time Operating System.

Scan Chain

A group of one or more registers from one or more TAP controllers connected between TDI and TDO, through which test data is shifted.

Semihosting

A mechanism whereby the target communicates I/O requests made in the application code to the host system, rather than attempting to support the I/O itself.

SWI

Software Interrupt. An instruction that causes the processor to call a programmer-specified subroutine. Used by ARM to handle semihosting.

TAP Controller

Logic on a device which allows access to some or all of that device for test purposes. The circuit functionality is defined in IEEE1149.1.

Target

The actual processor (real silicon or simulated) on which the application program is running.

TCK

The electronic clock signal which times data on the TAP data lines TMS, TDI, and TDO.

TDI

The electronic signal input to a TAP controller from the data source (upstream). Usually, this is seen when connecting the J-Link / J-Trace Interface Unit to the first TAP controller.

TDO

The electronic signal output from a TAP controller to the data sink (downstream). Usually, this is seen connecting the last TAP controller to the J-Link / J-Trace Interface Unit.

Test Access Port (TAP)

The port used to access a device's TAP Controller. Comprises TCK, TMS, TDI, TDO, and nTRST (optional).

Transistor-Transistor logic (TTL)

A type of logic design in which two bipolar transistors drive the logic output to one or zero. LSI and VLSI logic often used TTL with HIGH logic level approaching +5V and LOW approaching 0V.

Watchpoint

A location within the image that will be monitored and that will cause execution to stop when it changes.

Word

A 32-bit unit of information. Contents are taken as being an unsigned integer unless otherwise stated.

Chapter 21

Literature and references

This chapter lists documents, which we think may be useful to gain deeper understanding of technical details.

Reference	Title	Comments
[ETM]	Embedded Trace Macrocell™ Architecture Specification, ARM IHI 0014J	This document defines the ETM standard, including signal protocol and physical interface. It is publicly available from ARM (www.arm.com).
[RVI]	RealView® ICE and RealView Trace User Guide, ARM DUI 0155C	This document describes ARM's realview ice emulator and requirements on the target side. It is publicly available from ARM (www.arm.com).

Table 21.1: Literature and References

Index

-
- A**
 Adaptive clocking 472
 Application Program Interface 472
- B**
 Big-endian 472
- C**
 Cache cleaning 472
 Coprocessor 472
- D**
 Dirty data 472
 Dynamic Linked Library (DLL) 472
- E**
 Embedded Trace Buffer (ETB) 443, 472
 Embedded Trace Macrocell (ETM) .. 439, 472
 EmbeddedICE 472
- G**
 General Query Packets 122
- H**
 Halfword 472
 Host 472
- I**
 ICache 472
 ICE Extension Unit 472
 ID 473
 IEEE 1149.1 473
 Image 473
 In-Circuit Emulator 473
 Instruction Register 473
 IR 473
- J**
 J-Flash ARM 143
- J-Link**
 Adapters 434
 Developer Pack DLL 165
 Supported chips 258–259, 274–275, 282,
 292, 296
 J-Link Commander 83
 J-Link GDB Server 104
 J-Link RDI 160
 J-Link STR9 Commander 161
 J-Link TCP/IP Server 138
 J-Mem Memory Viewer 142
 Joint Test Action Group (JTAG) 473
 JTAG 436
 TAP controller 437
 JTAGLoad 159
- L**
 Little-endian 473
- M**
 Memory coherency 473
 Memory management unit (MMU) 473
 Memory Protection Unit (MPU) 473
 Menu structure 312
 Multi-ICE 473
- N**
 nTRST 418, 473
- O**
 Open collector 473
- P**
 Processor Core 474
 Program Status Register (PSR) 474
- R**
 RDI Support 160
 Remapping 474
 Remote Debug Interface (RDI) 474
 RESET 473

RTCK	474
RTOS	474
S	
Scan Chain	474
Semihosting	474
Server command	
clrbp	112
cp15	112
DisableChecks	112
EnableChecks	113
flash breakpoints	113
go	113
halt	114
jtagconf	114
memU16	115
memU8	114
reg	115
reset	116
setBP	116–118
sleep	119
speed	119
step	119
waithalt	121
wice	121
SetDbgPowerDownOnClose	244, 247
SetSysPowerDownOnIdle	248
STRACE	123
Support	465, 471
Supported flash devices	260–261, 267, 276
SWI	474
Syntax, conventions used	15
T	
Tabs	203
TAP Controller	474
Target	474
TCK	418, 474
TCP/IP	316
TDI	418, 474
TDO	418, 475
Test Access Port (TAP)	475
Transistor-transistor logic (TTL)	475
U	
USB	316
W	
Watchpoint	475
Word	475